



Ritmonio

Living a quality experience.

75T001
75T002
75T003
75T004

- IT** Istruzioni di montaggio, d'uso e manutenzione - leggere attentamente prima dell'installazione
- EN** Assembly, use and maintenance instructions - read carefully before installing
- FR** Instructions de montage, d'utilisation et d'entretien - lire attentivement avant l'installation
- DE** Montage-, Gebrauchs- und Wartungsanleitung - vor der Installation aufmerksam lesen
- ES** Instrucciones de montaje, de uso y manutención - leer atentamente antes de la instalación

- IT** Attenzione: L'installazione deve essere eseguita da personale qualificato
- EN** Warning: this product must be installed by qualified people
- FR** Attention: L'installation doit être exécutée par un personnel qualifié
- DE** Achtung: Die Installation muss von qualifiziertem Fachpersonal vorgenommen werden
- ES** Atención: La instalación deberá ser efectuada por personal cualificado

RITMONIO IS A CERTIFIED COMPANY

Dimensioni generali / General dimensions

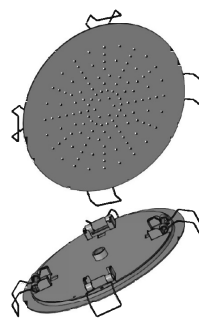
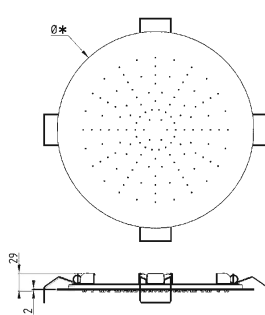
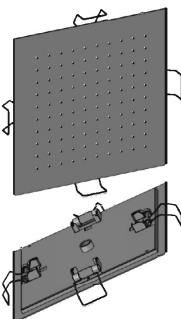
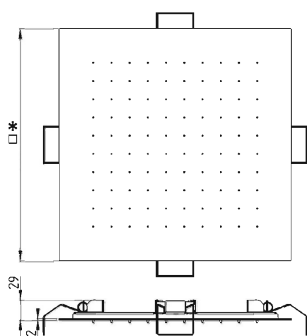

MAX 70°C
BEST 38/40°C



MIN 1 Bar
MAX 5 Bar
BEST 3 Bar

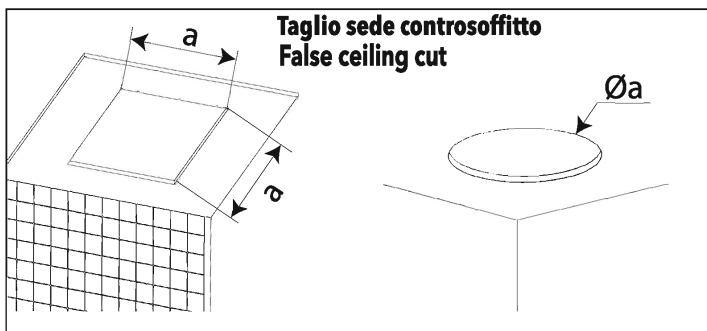
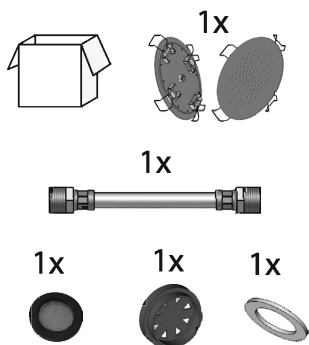

(*)Dimensioni esterne prodotto (mm) External product size (mm)	(a)Dimensioni min. foro controsoffitto(mm) Min. hole to drill in the false ceiling(mm)	(a)Dimensioni Max. foro controsoffitto (mm) Min. hole to drill in the false ceiling(mm)
Ø340	Ø300	Ø310
Ø440	Ø400	Ø410
340x340	300x300	310x310
440x440	400x400	410x410



L'apparecchio deve essere installato da personale abilitato ai sensi e per l'effetto delle leggi in vigore.
According to the law, all installation and maintenance operations require a qualified person.

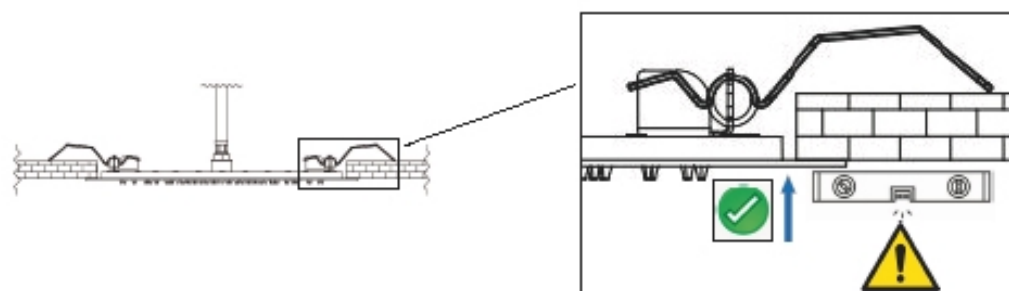
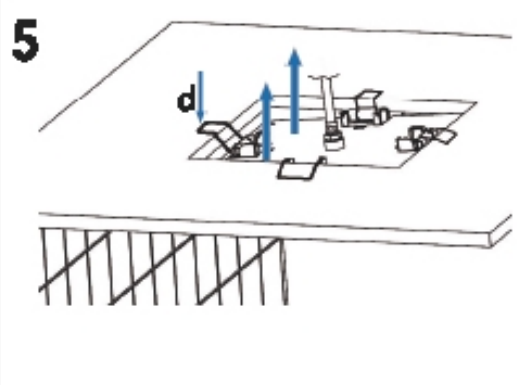
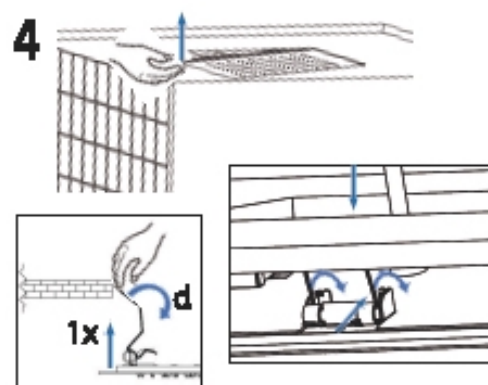
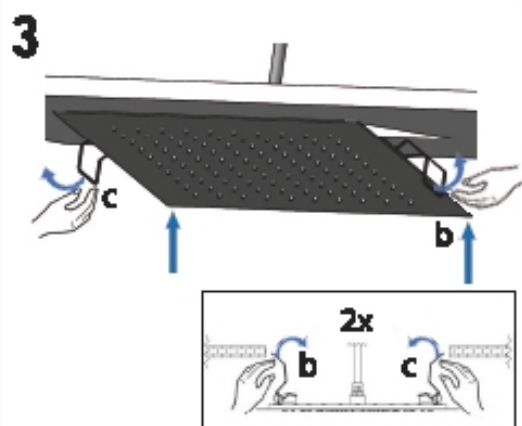
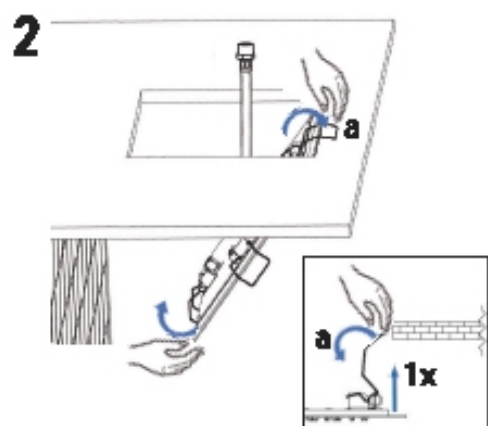
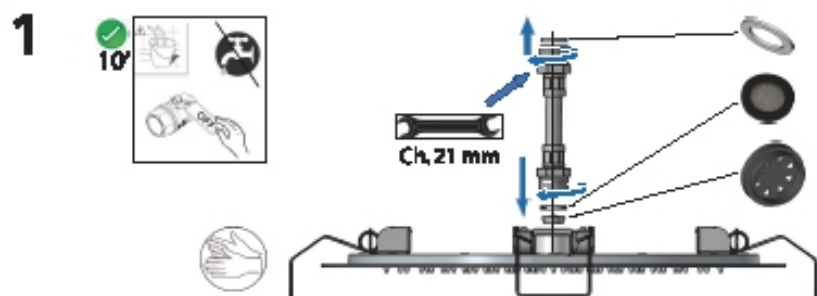

 Il soffione può essere ispezionabile per la pulizia.
The shower head can be inspected for cleaning

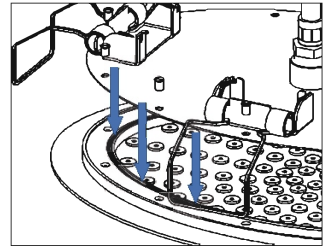
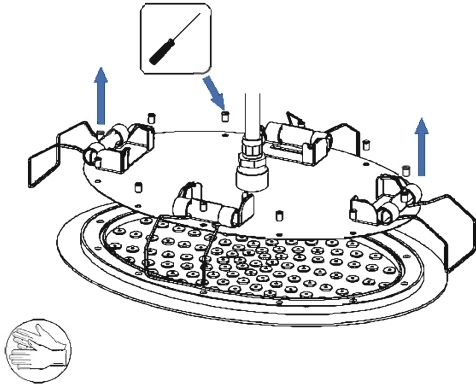

 Verificare che l'O-Ring sia nella sede.
Verify that the O-Ring is in the seat.

