

Instrucciones de montaje
Assembly instructions

Serie CLEAR

lateral fijo
side fixed panel

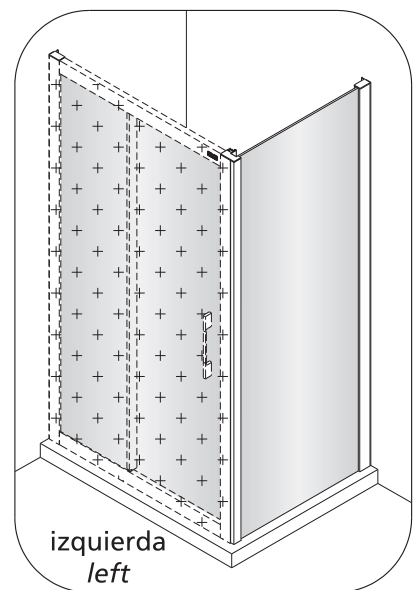
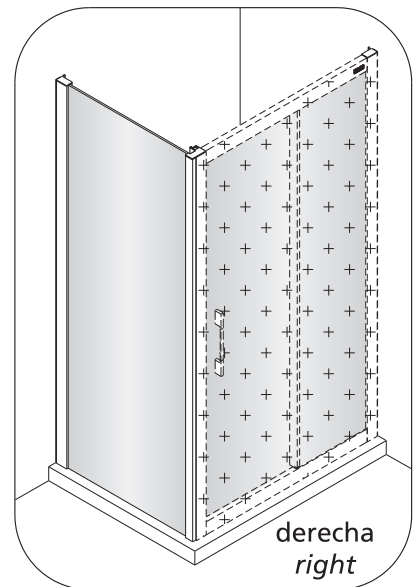
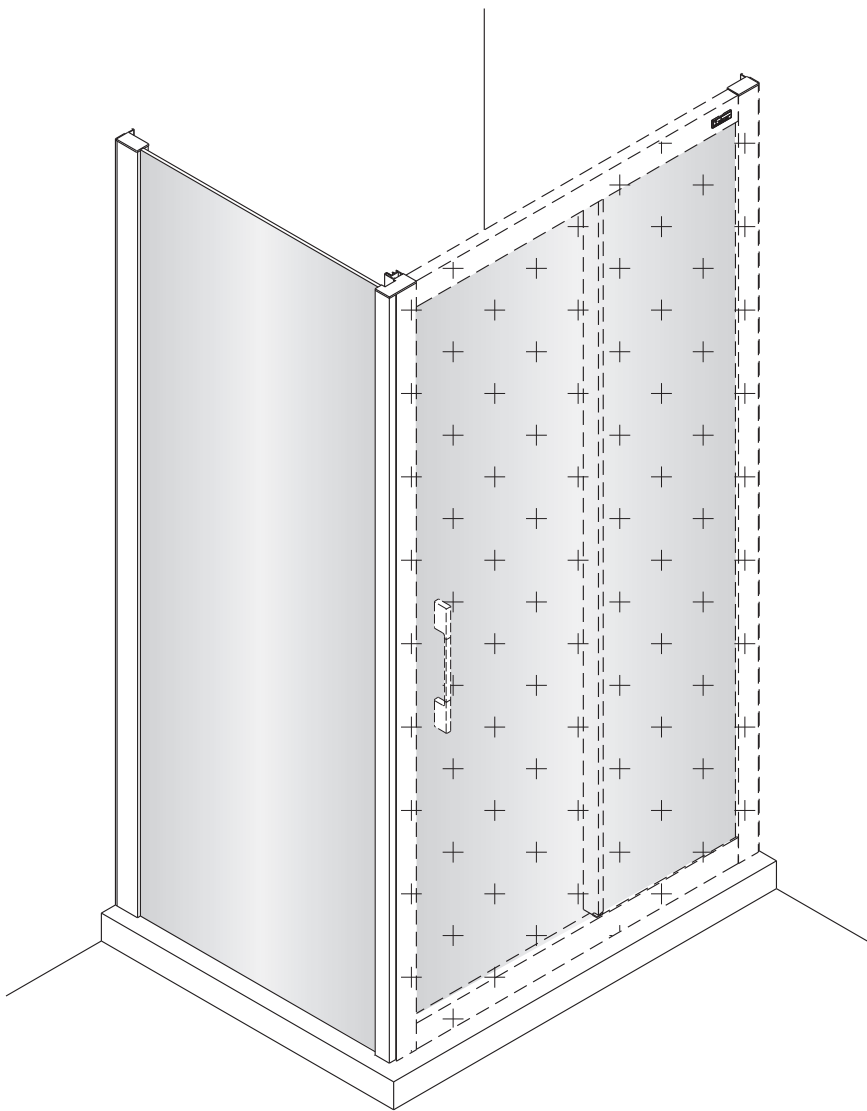

Salsar

Herramientas necesarias / Tools required

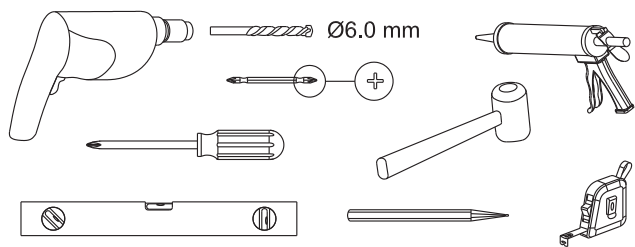

No.	descripción / description	Unds. / Qty
A	Arandela / Washer	2
B	Tornillo perfil / Profile screw	2
C	Tapón tornillos / Screw cap	2
D	Tapa perfil esquina / Corner profile cap (R)	1
E	Tapa perfil esquina / Corner profile cap (L)	1
F	Cristal fijo / Side panel	1
G	Tapa p. expansor/ Wall p. adjustable cap	1
H	Tapa p. expansor/ Wall p. adjustable cap	1

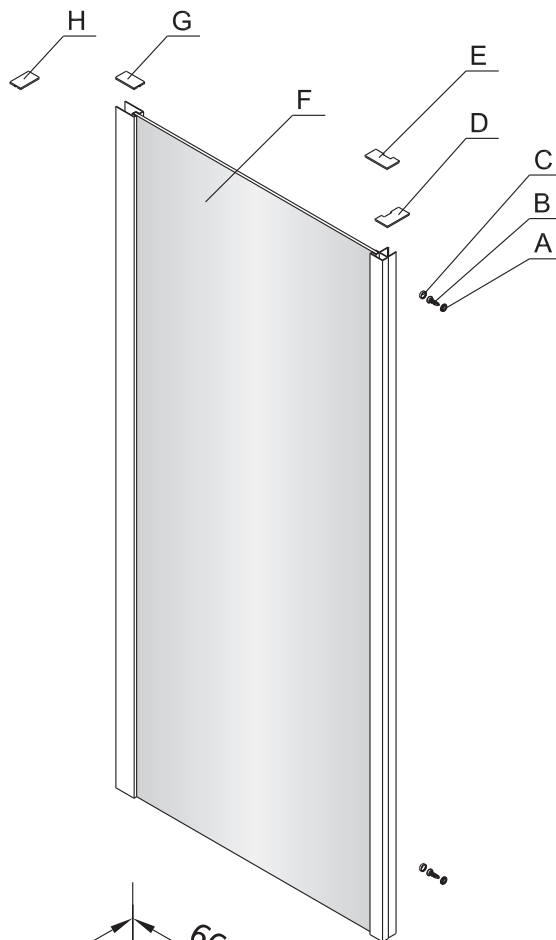

1

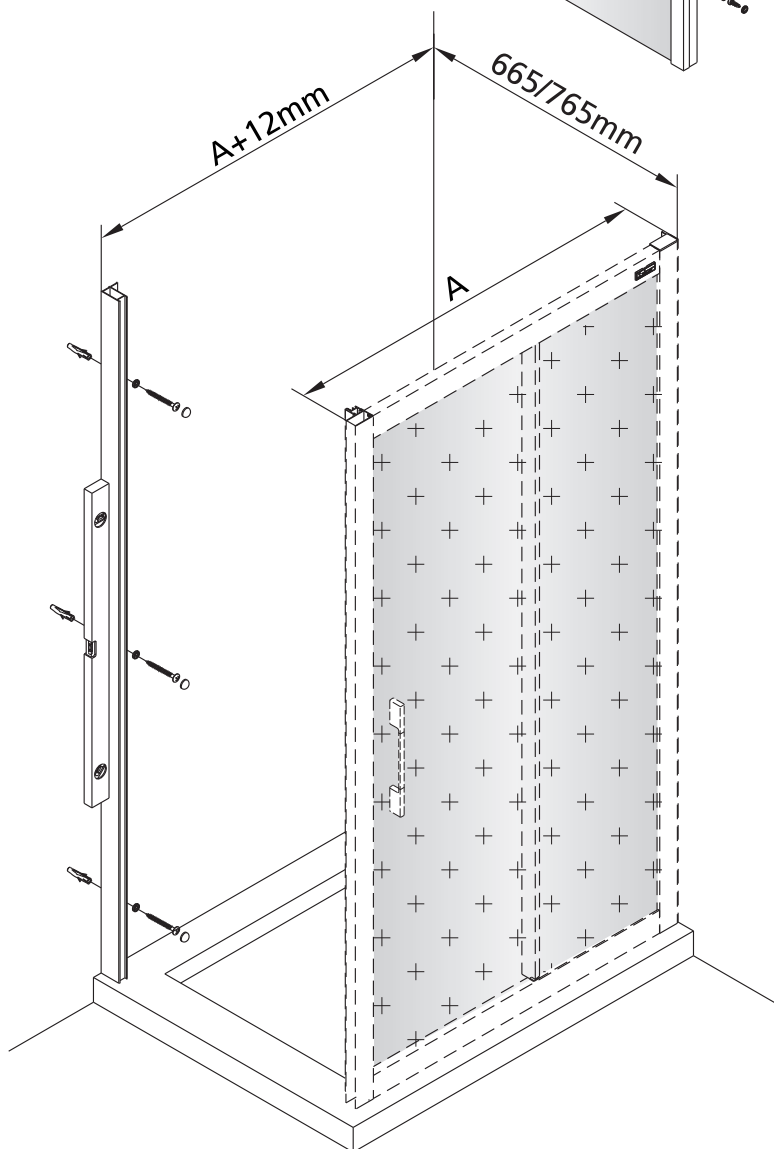
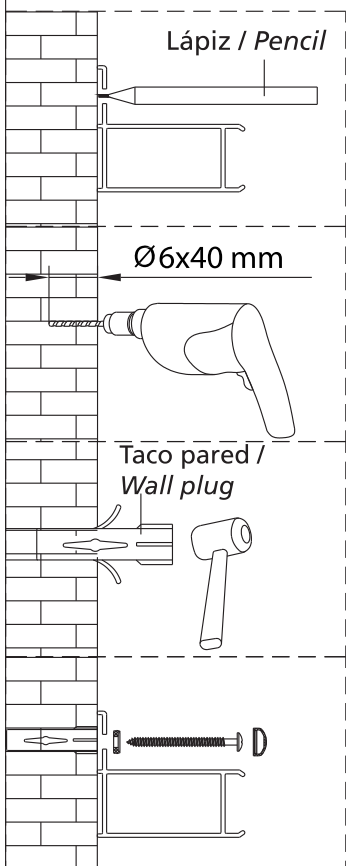

2

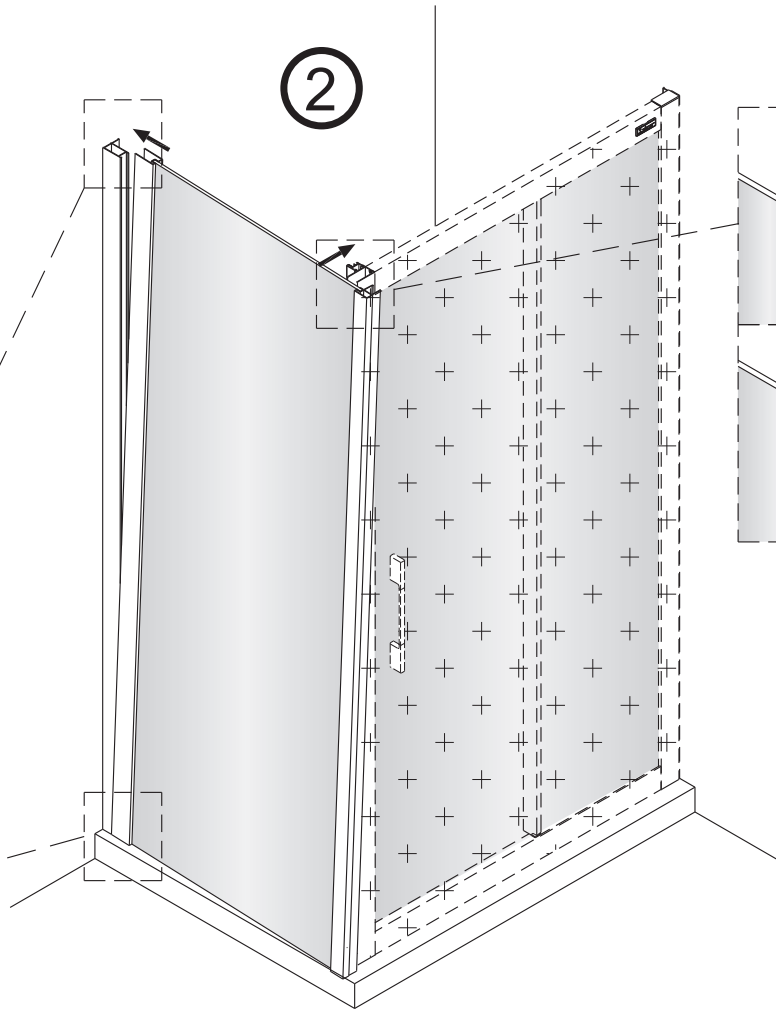
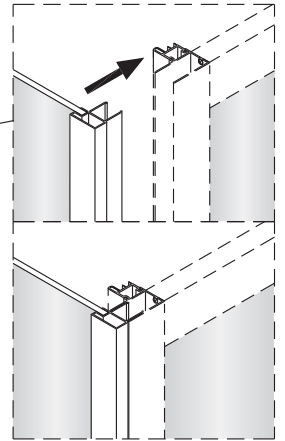
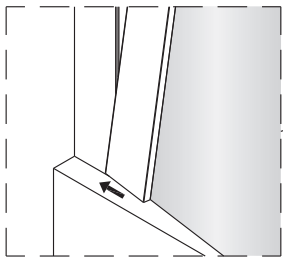
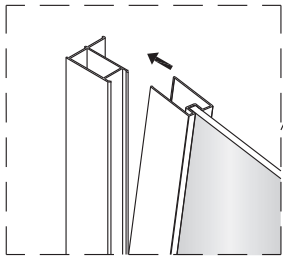
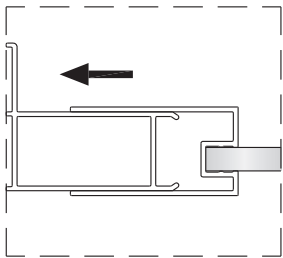

3

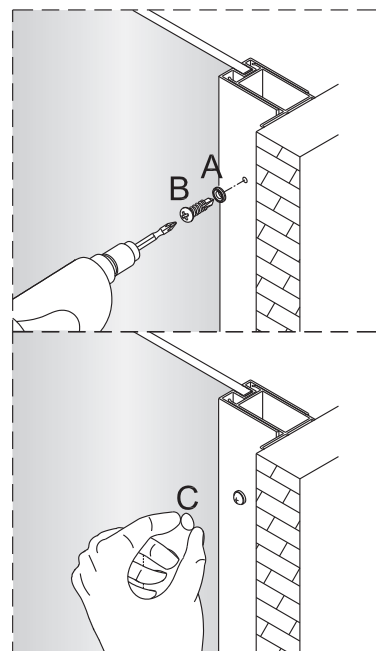
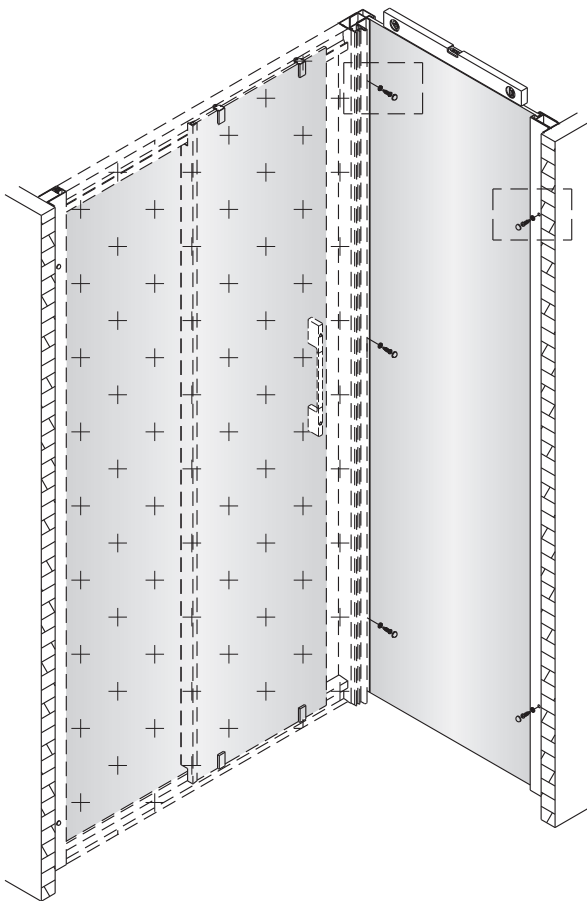

4

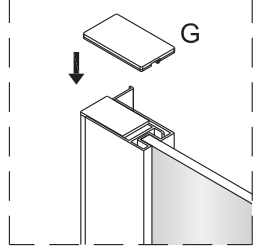
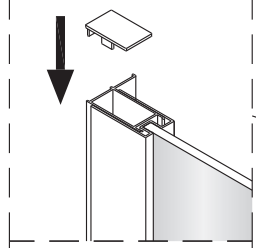

izquierda
left

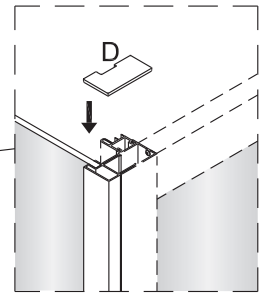
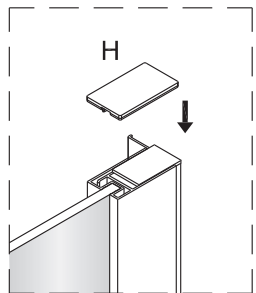

izquierda
left

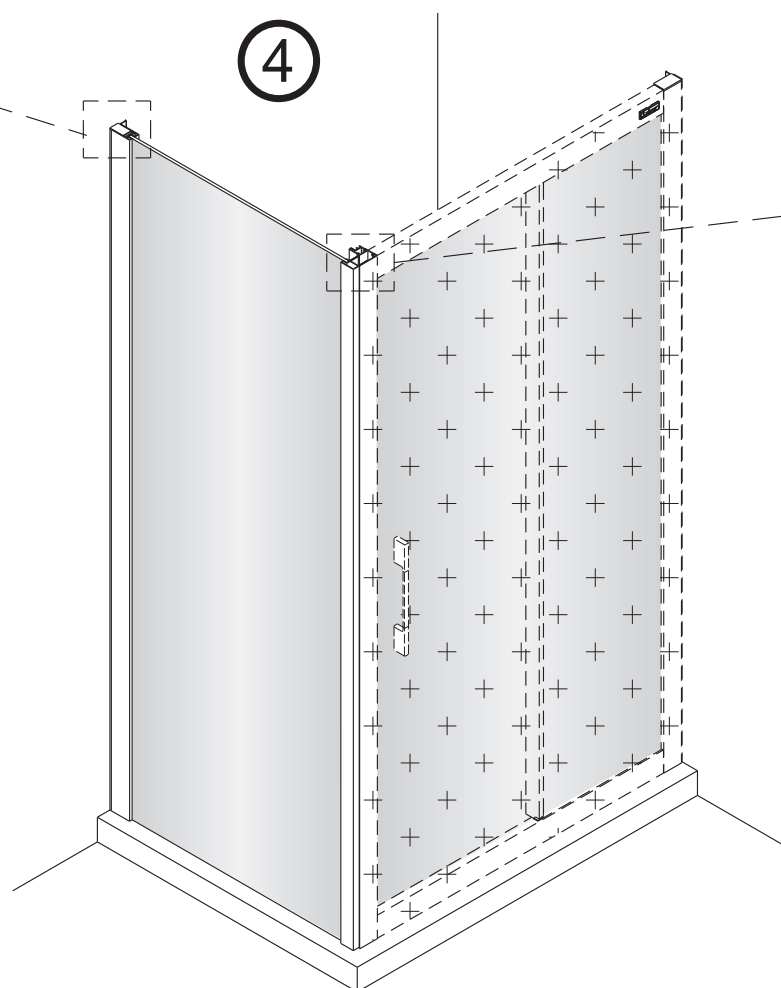
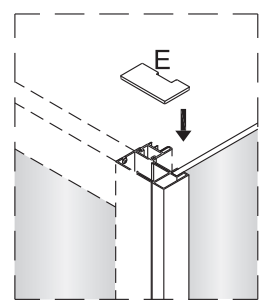

5

