

Hood Ghost 90 Filotop 2451 090

Hoods

Code: 2451 090



DETAILS

Coloring Black

Material Stainless steel + glass

Texture Satin

Height from floor 300mm

Energy class A

Product details Filotop inserting

Dimensions on plane 875x120mm

Grease filters 2 grease adonized aluminium filtre

Operation Suction hood (filtering mode with optional carbon filters)

Cut out 842x100 mm

Air exhaust hole \varnothing 120/150 mm

Lighting LED Strip lighting (5W - 4.200 kelvin)

Notes: The motor can be positioned frontally, on the back of the hood and in remote mode with the appropriate optional kit.

Air flow rate 760mc/h

Motor power 275W

Hood type Table-top hood

Type of commands Touch Control

Suction speed 4 operating speeds

Notes: Fume exhaust ducts must have an internal diameter not lower than 120 mm

FEATURES

Auto delayed shutdown All the models with electronic interface can be programmed to turn off the suction at a postponed moment, so as to prolong the aeration of the room even after the cooking has been completed.

Filter cleaning notice This function keeps track of the hours of use of the hood and signals the need to wash the filters in order to maintain the perfect efficiency of the hood.

Led lighting

Particular attention to energy saving with LED lighting systems. They assure a 10 times lower consumption and a 10 times longer duration. Our LED lights are designed to create an adequate comfort and safety in the cooking area.

TECHNICAL DATA

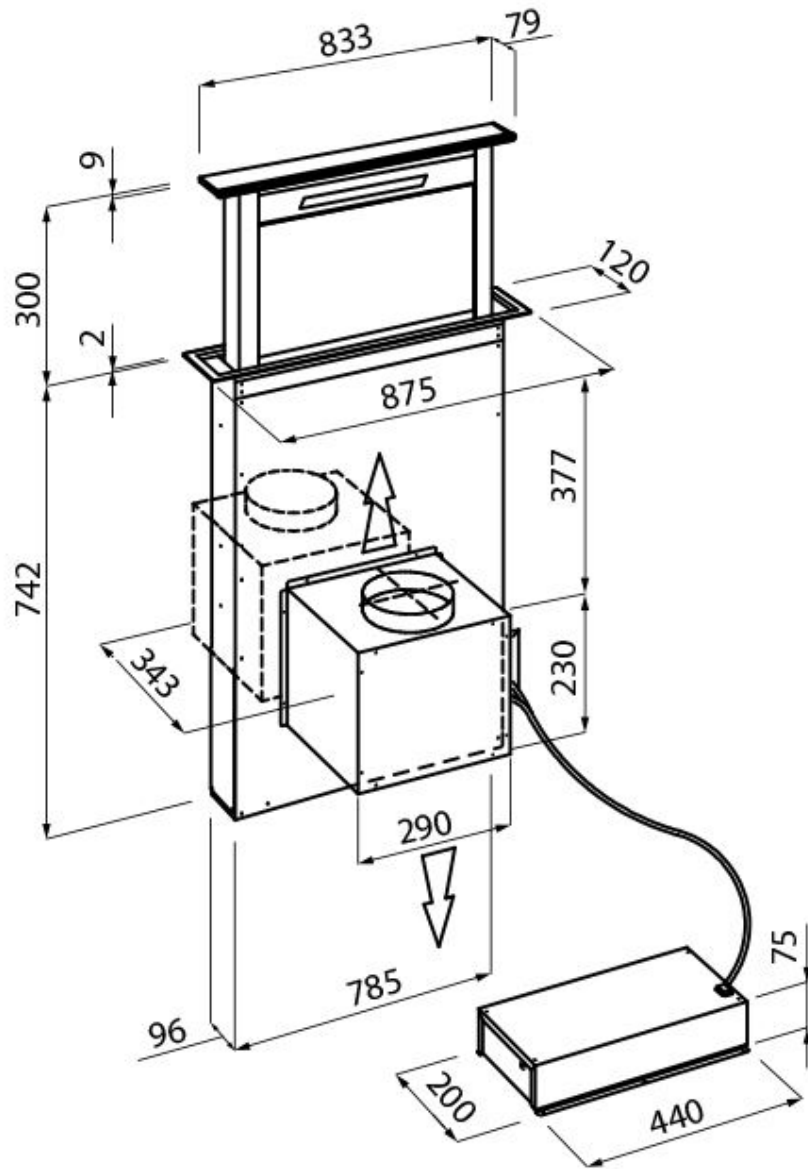

GALLERY

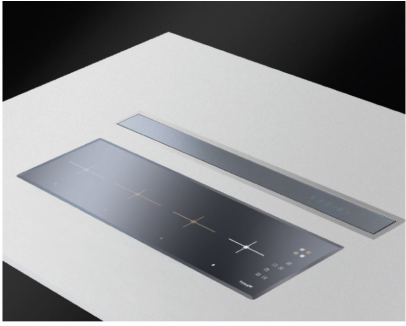

OPTIONAL ACCESSORIES



Carbon filters kit 9700 460

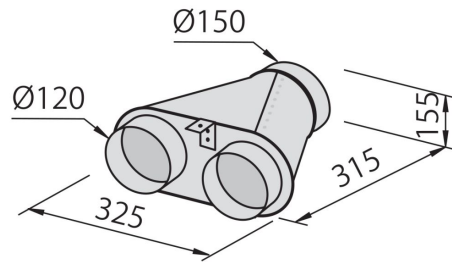

Collector for 2 pipes 2523 000

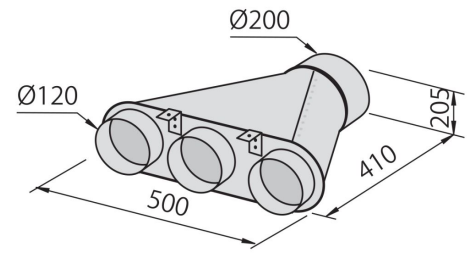

Collector for 3 pipes 2524 000

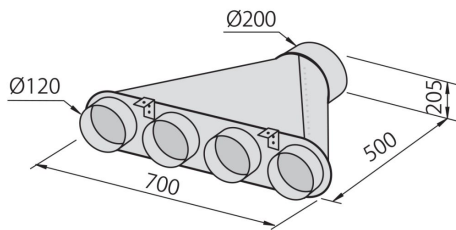

Collector for 4 pipes 2525 000



Flexible silencing canalization
9700 602



Flexible silencing canalization
9700 603

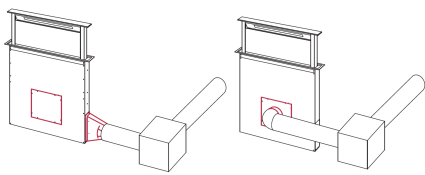

Remote engine installation kit
9700 459

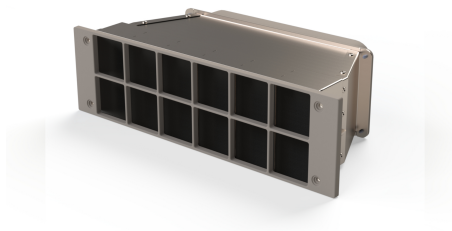

Carbon filter - 9700 574