

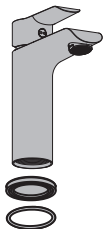

Гарантия
5
лет*

BORDEAUX



M10X1

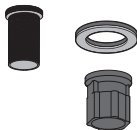
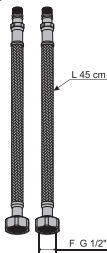

EAN CODE: 3276007035414

RU Руководство по
BY Эксплуатации

KZ Пайдалану жөніндегі
басшылық

EN Instructions Manual

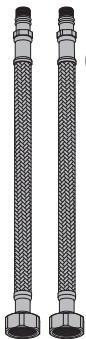
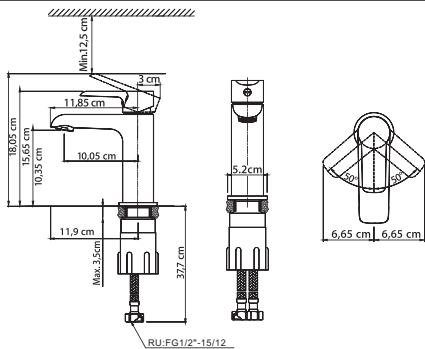

D

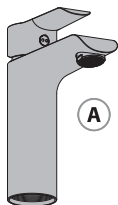

A



B



C



E



F



G



MIN. 35 mm





RU/BY: Подготовка / **KZ:** Дайындау / **EN:** Preparation



4



RU/BY: Сборка / **KZ:** Құрастыру / **EN:** Assembly



5 → 7



RU/BY: Использование горячей и холодной воды/
KZ: Суық және ыстық суды қолдану / **EN:** Using hot and cold water



8

RU/BY: Смена картриджа / **KZ:** Картриджді ауыстыру / **EN:** Replacing the cartridge



9 → 12

RU/BY: Смена аэратора / **KZ:** Аэратор ауыстыру / **EN:** Replacing the aerator



13

RU/BY: Смена гибкого шланга для смесителя /

KZ: Қоспалауышқа арналған иілгіш шлангты ауыстыру / **EN:** Replacing the hoses



14 → 15



RU/ВУ: Подготовка / KZ: Дайындау / EN: Preparation

1

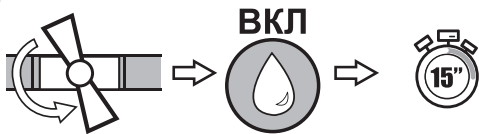

2

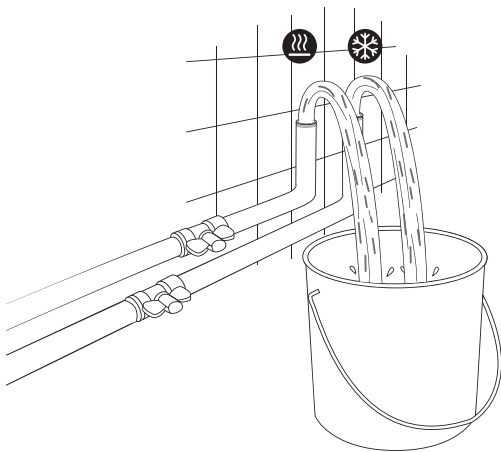

3

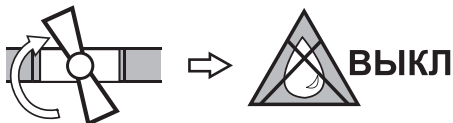



RU/ВУ: Сборка / KZ: Құрастыру / EN: Assembly

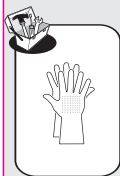
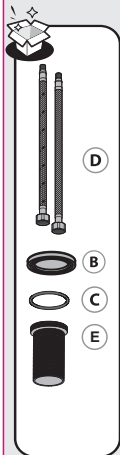

1

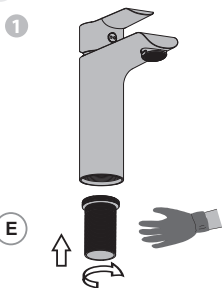

3

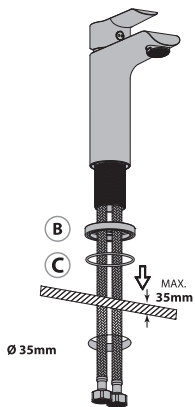

2

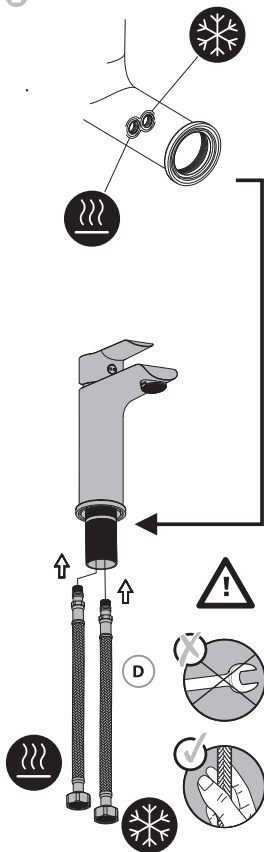



F



G



2

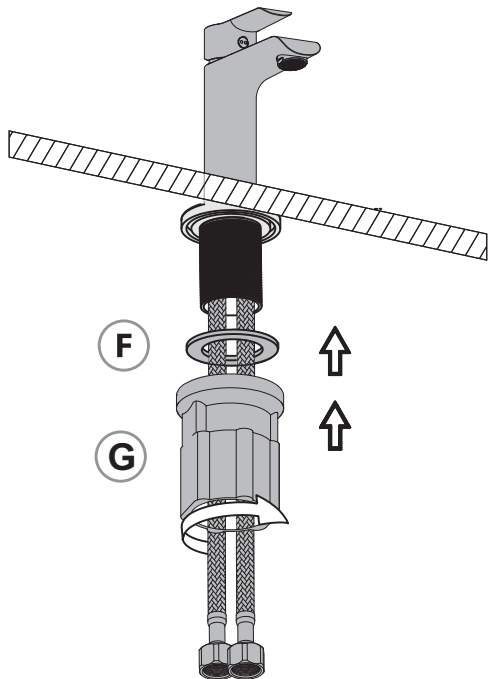

F

G



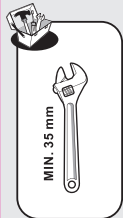

3

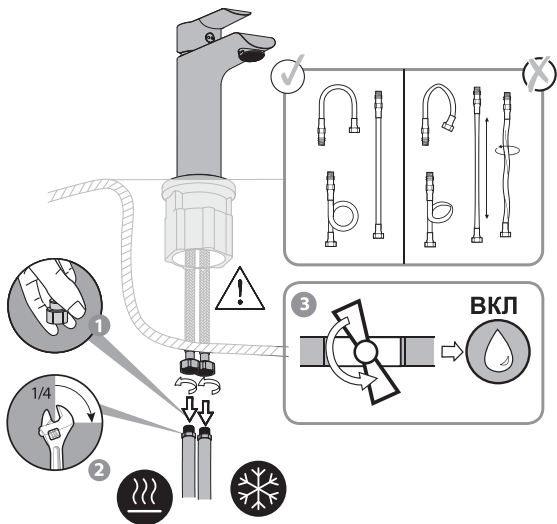



RU/БҮ:Использование горячей и холодной воды/
KZ: Суық және ыстық суды қолдану/ EN: Using hot and cold water

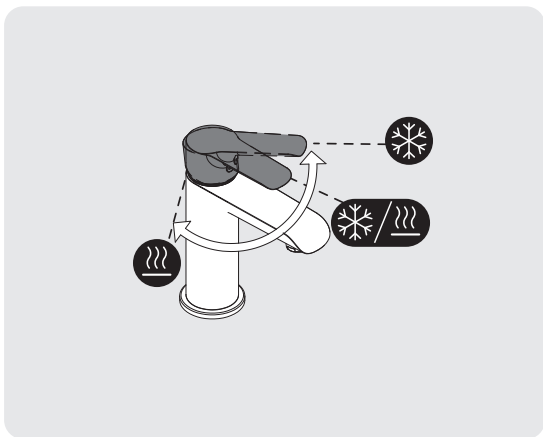
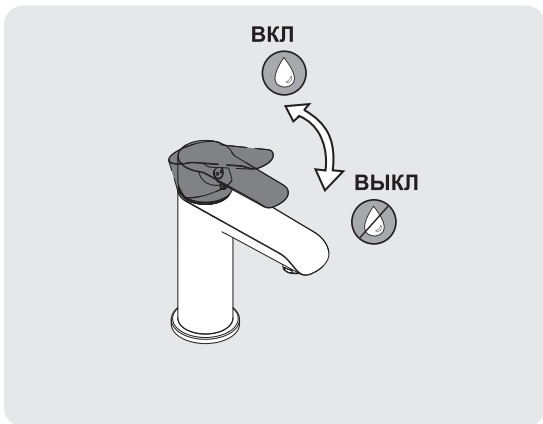

No./Номер/Нөмір	Description/Описание/Сипаттама	Code No./Номер кода/Код нөмірі	QTY/Кол-во/Мөлшері
1	Handle/Ручка/Тұтқа	H8720	1
2	Cartridge/Картридж/Картридж	35H-10	1
3	Fixing part/Крепеж/Бекіту бөлігі	41038000300	1
4	Neoperl/Aэратор/Aэратор	40.0003.000	1
5	Inlet hose/Гибкий шланг/Кіріс шланг	21450300303	2

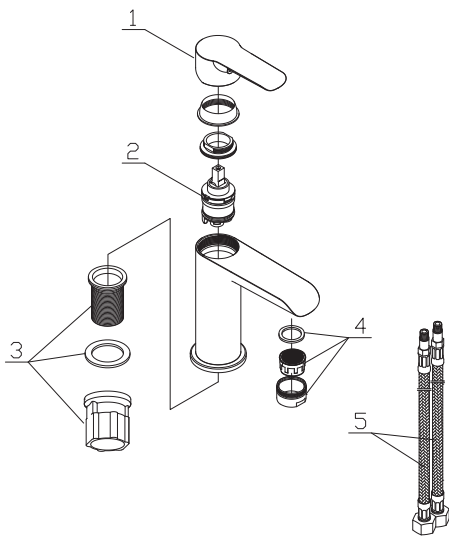

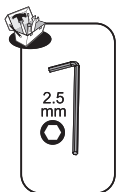

RU/BY: Смена картриджа/ **KZ:** Картриджді ауыстыру/
EN: Replacing the cartridge

1



ВЫКЛ

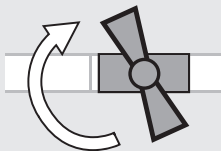

2

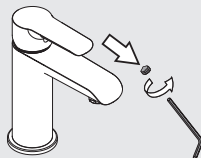

3

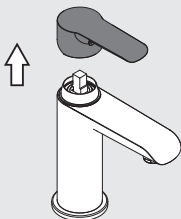

4



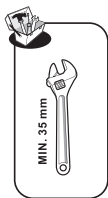

RU/BY: Смена картриджа/ **KZ:** Картриджді ауыстыру/
EN: Replacing the cartridge

5

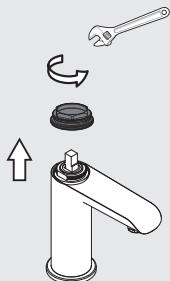

6

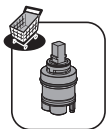
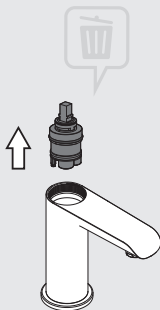

7

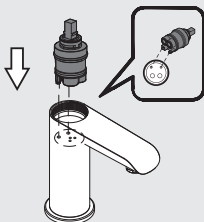

8

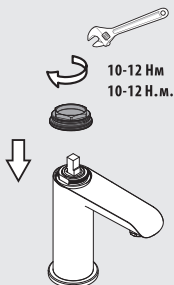



RU/BY: Смена картриджа/ **KZ:** Картриджді ауыстыру/
EN: Replacing the cartridge

9



10

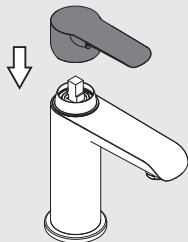

11

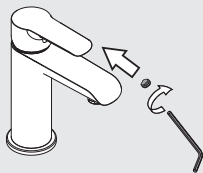

12

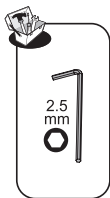

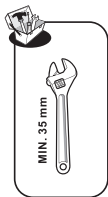

RU/ВУ: Смена аэратора/ KZ: Аэратор ауыстыру/ EN: Replacing the aerator

1

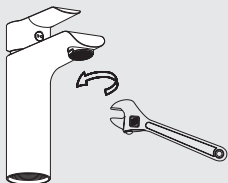

2

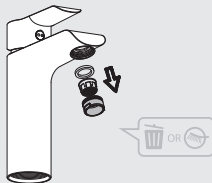

Чистка тазарту Cleaning



3

Уксус Сірке су Vinegar

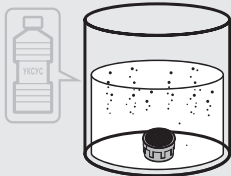

4

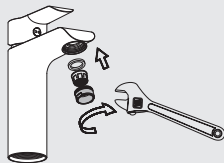

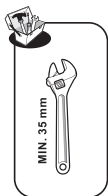

RU/БҮ: Смена гибкого шланга для смесителя/
KZ: Қоспалауышқа арналған иілгіш шлангты ауыстыру/ EN: Replacing the hoses

1



ВЫКЛ

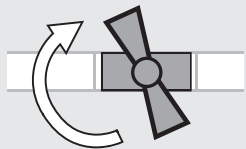

2

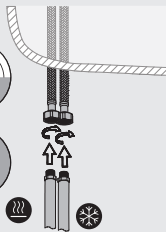

3

ВКЛ



4

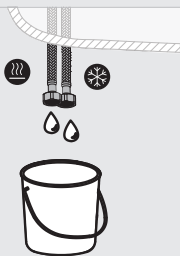

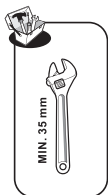

RU/БҮ: Смена гибкого шланга для смесителя/
KZ: Қоспалауышқа арналған иілгіш шлангты ауыстыру/ EN: Replacing the hoses

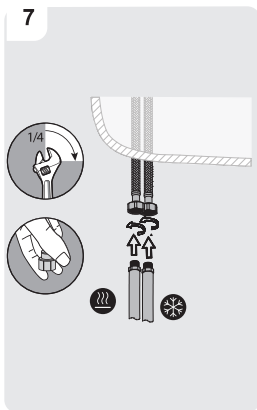
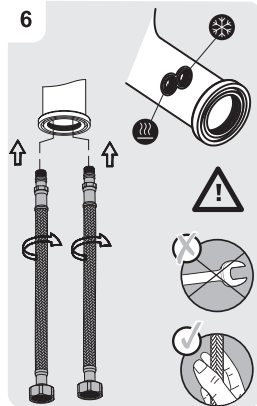
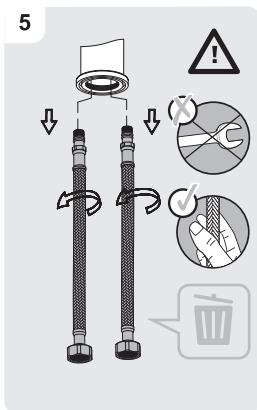



Чистая вода / Таза су / Clean water



Без розчинителя / Еріткішсіз / Solvent-free

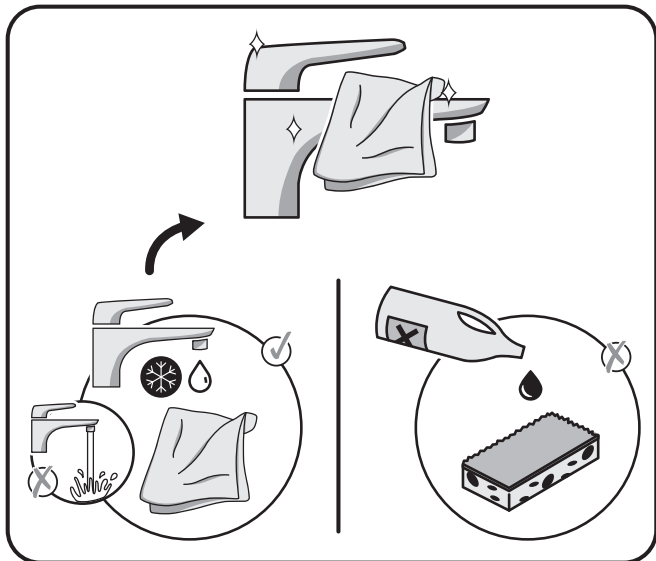



Декларация о соответствии санитарным нормам
Санитарлық талаптарға сәйкестік декларациясы
Declaration of sanitary conformity.

* Кепілдік 5 жыл / Гарантия 5 лет / 5-year guarantee

Made in P.R.C. 2019

FR ADEO Services - 135 Rue Sadi Carnot - CS 00001
59790 RONCHIN - France

UA ТОВ «Леруа Мерлен Україна»,
вул. Полянка 17а, м. Київ 04201, Україна

RU ООО ЛЕРУА МЕРЛЕН ВОСТОК, 141031, Московская
область, г. Мытищи, Осташковское шоссе, д.1, РОССИЯ

BY ООО «Леруа Мерлен Бел», 220020, Республика Беларусь,
город Минск, проспект Победителей, 100, офис 503

KZ Қазақстан Республикасында өнім сапасы бойынша
наразылықтарды қайыпқа ұялетті ұйым: «Леруа Мерлен
Қазақстан» ЖШС, Қазақстан Республикасы, 050000,
Алматы қ., Қонаев көшесі, 77, «PARKVIEW» БО, 6-қабат, 07-кеңсе.
Организация, уполномоченная принимать претензии по
качеству продукции в Республике Казахстан: ТОО «Леруа
Мерлен Казахстан», Республика Казахстан, 050000, г. Алматы,
ул. Куняева, 77, БЦ «ParkView», 6 этаж, офис №07.

