

34-1.2-AUT-★

Wall Mounted Automatic Faucet

★ See next page for function options

Not temperature control – water must be premixed

Flow Rate: 1.2 GPM

Hole Diameter: 1 7/8"

Note: Sensor box may be installed a maximum of 12" linear from center of inlet.

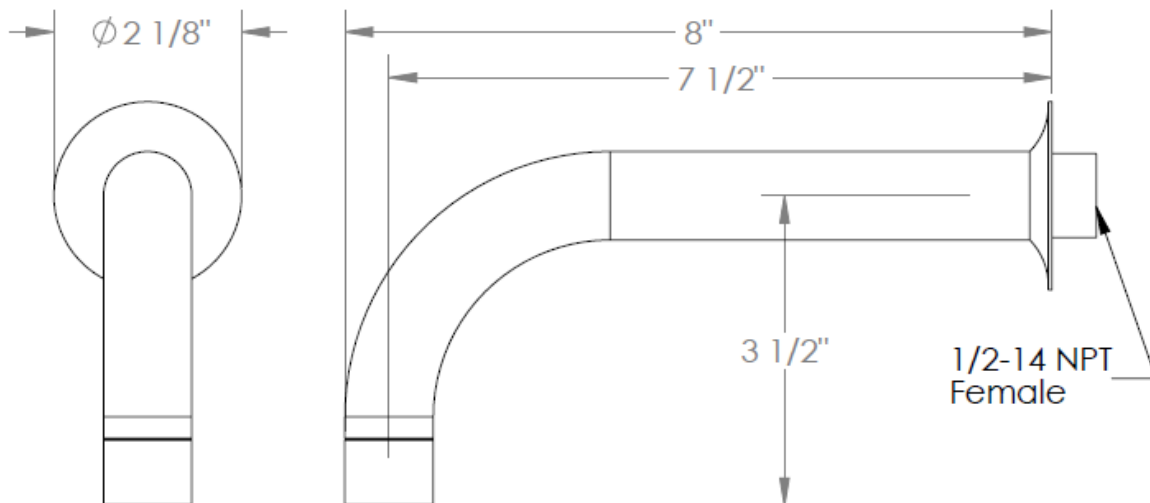

AUT-W-RGH

Automatic Faucet System

Includes CR-P2 6V Battery

WTM2 and WPM4: 12s metering cycle

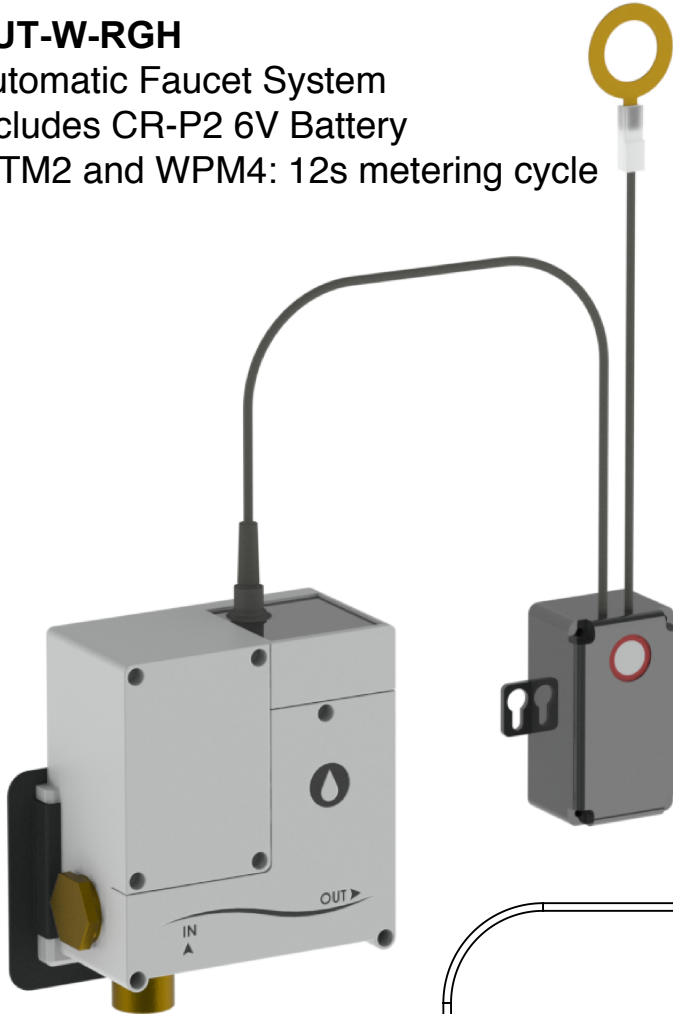

★ Function Options	
Code	Function
WT1	Touch on/off
WTM2	Metered touch
WP3	Touchfree
WPM4	Metered touchfree

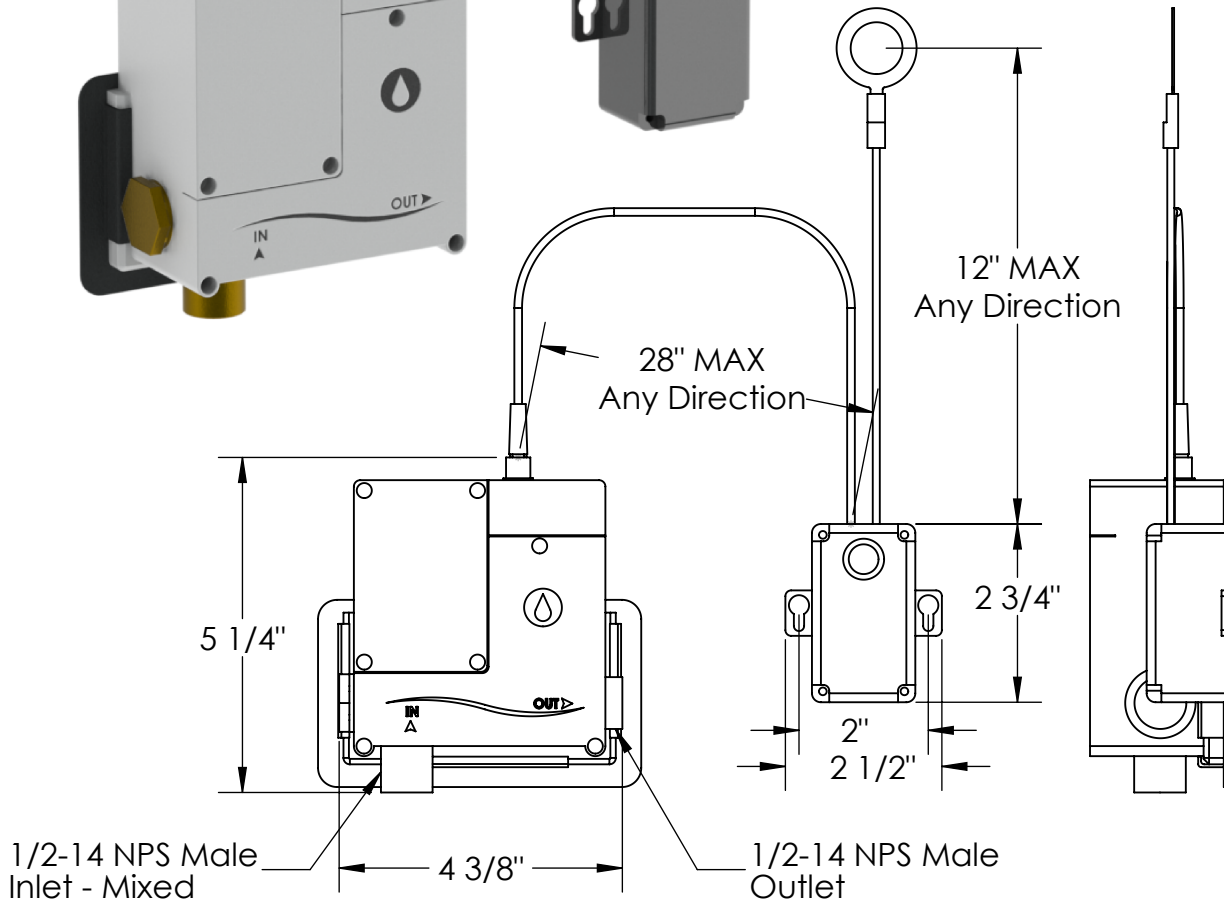

Meets the applicable requirements of ASME A112.18.1-2005/CSA B125.1-05, entitled "Plumbing Supply Fittings"