

VELIS 57x37 TRASLATO

CATALANO
THE ESSENCE OF CERAMICS

cod. 1VPT5700

Wc scarico a parete trasformabile a terra tramite curva tecnica.

Wc with horizontal outlet convertible to flooroutlet by a pipe fitting.

WC mit Wandabfluss, durch Kurventechnik auf Bodenabfluss umrüstbar.

cod. 5CAWC00

Raccordo di alimentazione regolabile
adjustable pipe fitting

cod. Z542386

Fissaggio a parete.
wall fixing elements

cod. 5V57STF000

Sedile soft-close in resina inalterabile.

Soft-close Seat-cover made of unalterable resin.

WC-Sitz SoftClose aus beständigem Harz.



CE EN 997 - CL1 - 5A

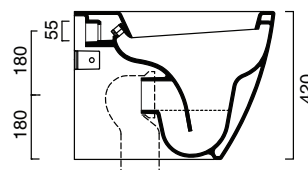
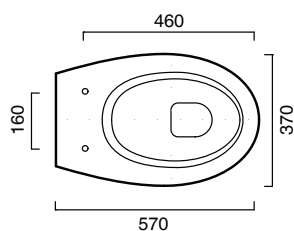

Fissaggio a parete
how to install the toilet.

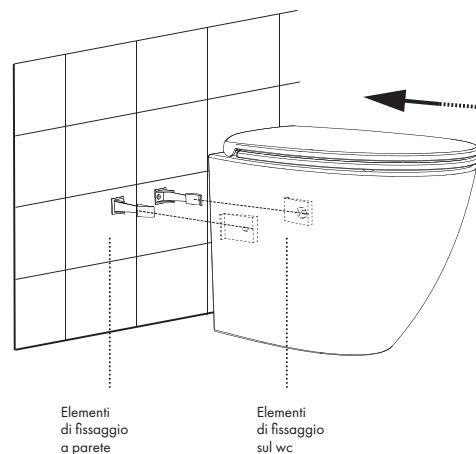

Regolazioni dei kit di alimentazione e scarico
adjustments for inlet and outlet pipes.

Curva tecnica fissa - Standard pipe elbow fitting
Cod. 5CUIG00

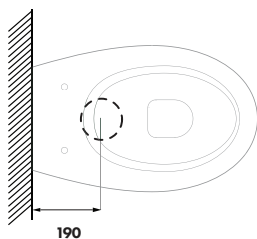

Raccordo di alimentazione regol - Adjustable pipe fitting
Cod. 5CAWC00

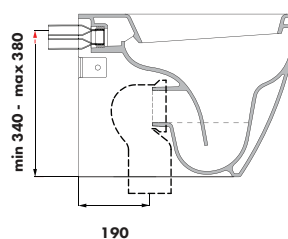

Curva tecnica regolabile - Adjustable pipe elbow fitting
Cod. 5CU0400

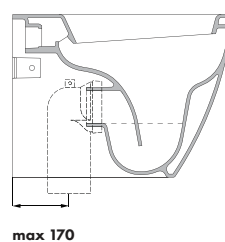
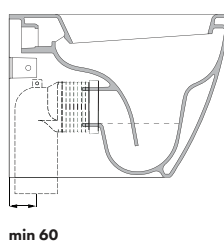
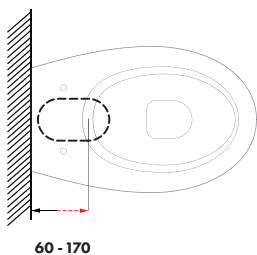

Curva tecnica regolabile - Adjustable pipe elbow fitting
Cod. 5CU0300

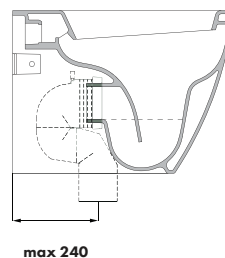
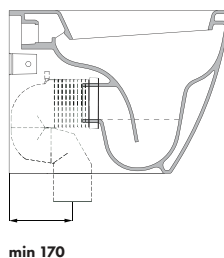
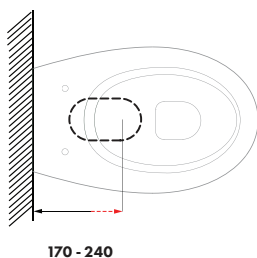

MADE IN ITALY

GARANZIA

Il rivenditore sostituirà i prodotti con difetti di fabbricazione entro due anni dalla consegna.

Your retailer will replace products with faults of manufacturing within two years from delivery date.

Der Wiederverkäufer wird Produkte mit Fabrikationsfehlern innerhalb 2 Jahren seit Zustellung ersetzen.

PULIZIA

Si consiglia di pulire con acqua tiepida e detersivo non abrasivo.

The maintenance has to be done with tepid water and not abrasive detergents.

Für die Reinigung empfiehlt sich lauwarmes Wasser und keine Scheuermittel zu verwenden.

DICHIARAZIONE DI PERFORMANCE - DOP No 997

Scarica il documento al seguente link a lato:

Click the link on the side to download the document:

Klicken Sie auf den Link zum Herunterladen des Dokuments:

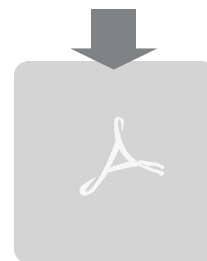

WATER LABEL

Una nuova etichetta informativa accompagna i WC Catalano, attribuita e certificata dalla The Water Label Company. L'etichetta mostra una classificazione di performance, indicando il volume massimo d'acqua che il wc utilizza nella fase di scarico.

All Catalano WCs have a new label, certified and issued by The Water Label Company. The label shows a performance ranking, indicating the maximum water volume of the toilet's flush.

Die Catalano-WCs besitzen eine neue Zertifizierung, die von der Water Label Company vergeben wird. Die Zertifizierung stellt eine Leistungsklassifizierung dar und gibt das maximale Wasservolumen an, das ein WC bei der Spülung verbraucht.

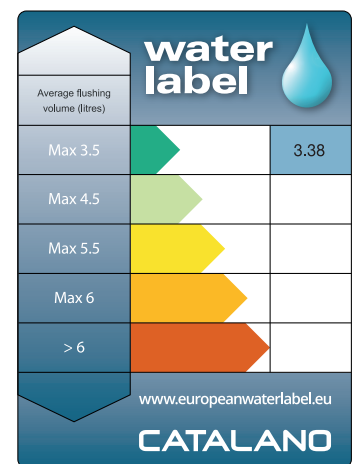

KIT DI FISSAGGIO

vedi il video al seguente link a lato:

Click the picture on the right to watch the video:

Klicke auf das Bild rechts, um das Video anzuschauen:



Antibacterial protection

CATAglaze[®] + Silver Titanium

CATALANO
THE ESSENCE OF CERAMICS

MADE IN ITALY

L'INNOVATIVO SMALTO ANTIBATTERICO SU TUTTA LA CERAMICA
THE INNOVATIVE ANTIBACTERIAL GLAZE IS STANDARD ON ALL
CATALANO PRODUCTS.

L'ÉMAIL ANTIBACTÉRIEN NOVATEUR SUR TOUTE LA CÉRAMIQUE

IT È un potenziamento dello smalto Cataglaze che, oltre a ridurre il deposito di calcare facilitando la pulizia dei sanitari ceramici, svolge una potente azione antimicrobica in grado di contrastare germi e batteri. L'efficacia della nuova formula è garantita dalla presenza nell'impasto di ioni d'argento e di titanio. L'azione antibatterica è certificata ISO 22196 con efficacia del 99,99%.

EN It is an improvement of Cataglaze glazing system; besides being more resistant to limescale and therefore easier to clean, it has a powerful antimicrobial action able to kill germs and bacteria. The effectiveness of the new formula is guaranteed by the presence in the mix of silver and titanium ions. The antibacterial action is ISO 22196 certified and it is 99.99% effective.

FR Il s'agit d'un renforcement de l'émail Cataglaze qui, en plus de réduire le dépôt de calcaire et donc faciliter le nettoyage des sanitaires en céramique, exerce une action antimicrobienne puissante en mesure de contraster les germes et les bactéries. L'efficacité de la nouvelle formule est garantie par la présence, dans le mélange, d'ions d'argent et de titane. L'action antibactérienne est certifiée ISO 22196 avec une efficacité de 99,99%.



Silver Titanium
Protezione antibatterica
Silver Titanium
Antibacterial protection
Silver Titanium
Protection antibactérienne

99,99%

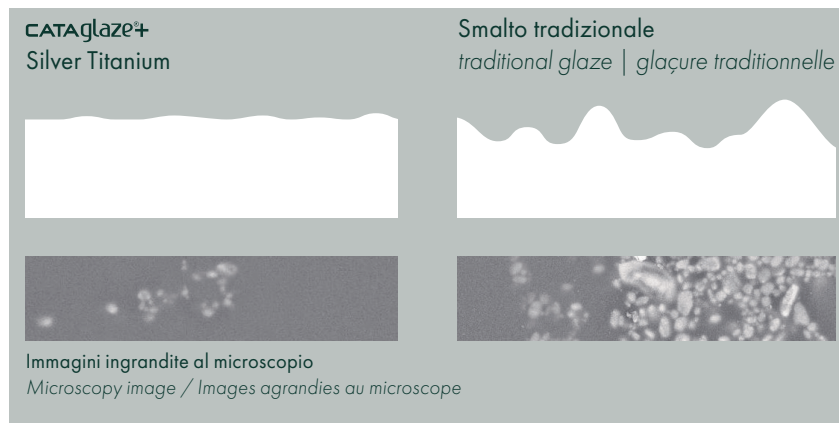

Maggiore brillantezza
Brightness
Aspect brillant



Resistenza agli agenti chimici
Resistance to chemicals
Résistant aux agents chimiques



Rispetto per l'ambiente
Respect for the environment
Respect de l'environnement



Pulizia facile e rapida
Quick cleaning
Nettoyage rapide



Igiene totale
Total hygiene
Hygiène totale



Lunga durata di vita
Long lifecycle
Longue durée

Tutti i diritti sulla presente scheda appartengono a Ceramica Catalano S.p.A. in via esclusiva. È vietata la copia, la pubblicazione, la distribuzione o la riproduzione (anche parziale), se non autorizzata per iscritto. All rights in the present form belong exclusively to Ceramica Catalano S.p.A. It is strictly forbidden to copy, publish, distribute or reproduce it (including any partial reproduction), without prior written permission.