

# 5194600

## FINEZZA DUE Series

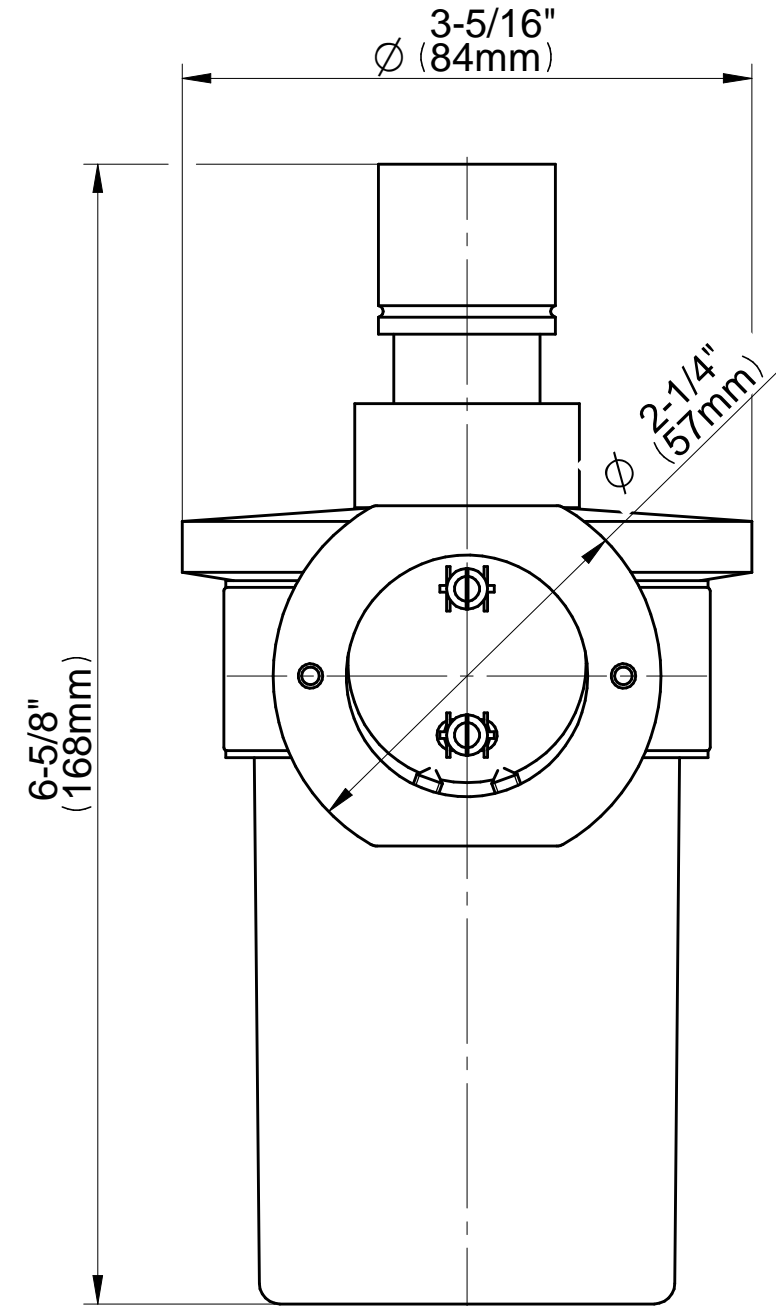
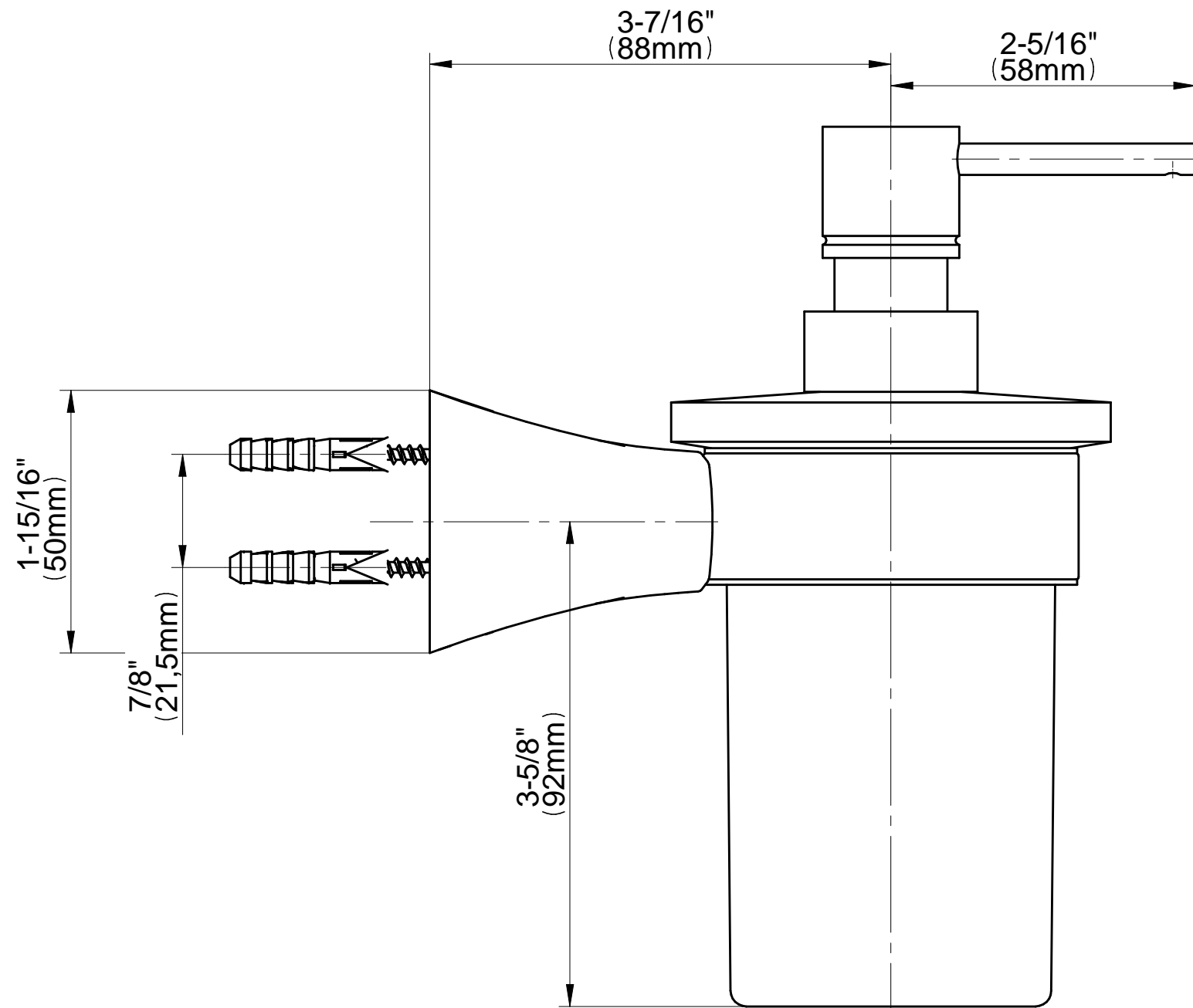

SOLID EDGE RESELLER COPY

**GRAFF**<sup>®</sup>  
CUTTING EDGE DESIGN