

Sink Phantom Edge Vintage Gun Metal - 4157 856

Sinks

Code: 4157 856



DETAILS

Coloring Gun Metal

Finish PVD

Material AISI 304 stainless steel

Texture Vintage

Base 80 cm

Edge/Installation Type Phantom Edge | Top 12 mm

Dimensions 752x442 mm

Standard fittings Drain, overflow and siphon, boxed packing

Mixer holes No standard holes

Built-in hole [View technical data sheet](#)

Drainer No

Bowl dimension 710x400mm

Number of bowls 1 bowl

Waste fitting 3,5" drain

FEATURES

Gun Metal The Gun Metal finish is obtained by treating steel with a physical process called PVD (Physical Vacuum Deposition) which deposits particles of noble metals on the surface. The result is a unique and refined aesthetic effect, and an improvement of the mechanical properties of the steel which is more resistant to impact and scratches.

VINTAGE PVD The prestigious PVD finish combines with the care for detail of the Vintage finish, to create a combination of unique elegance.

PHANTOM EDGE The Phantom Edge bowls are specifically manufactured for zero-edge installation. They are equipped with a perimetric fixing system onto which the worktop is lodged. The standard version is meant for 12mm-thick worktops.

High thickness 1mm thick steel. A significant thickness, which guarantees the maximum sturdiness and durability.

Small radius Bowls with squared shapes with a modern design and an increased capacity, for a minimal aesthetics connected with an extreme practicality.

Perimetral overflow The overflow is always a security on the Foster sinks that prevents the overflow of water in case of oversights. The perimeter drain solution improves aesthetics thanks to its square and essential shape.

TECHNICAL DATA

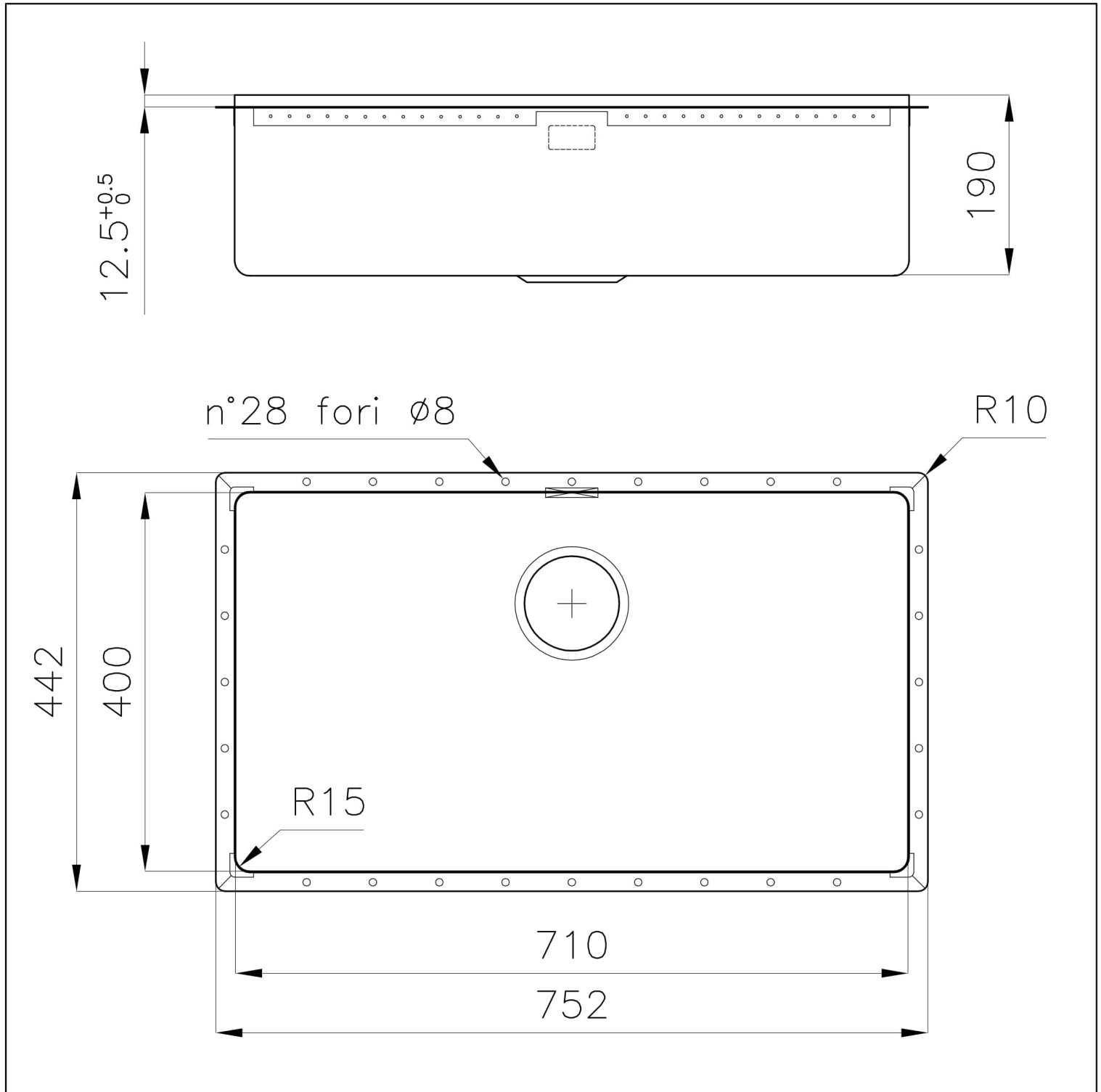

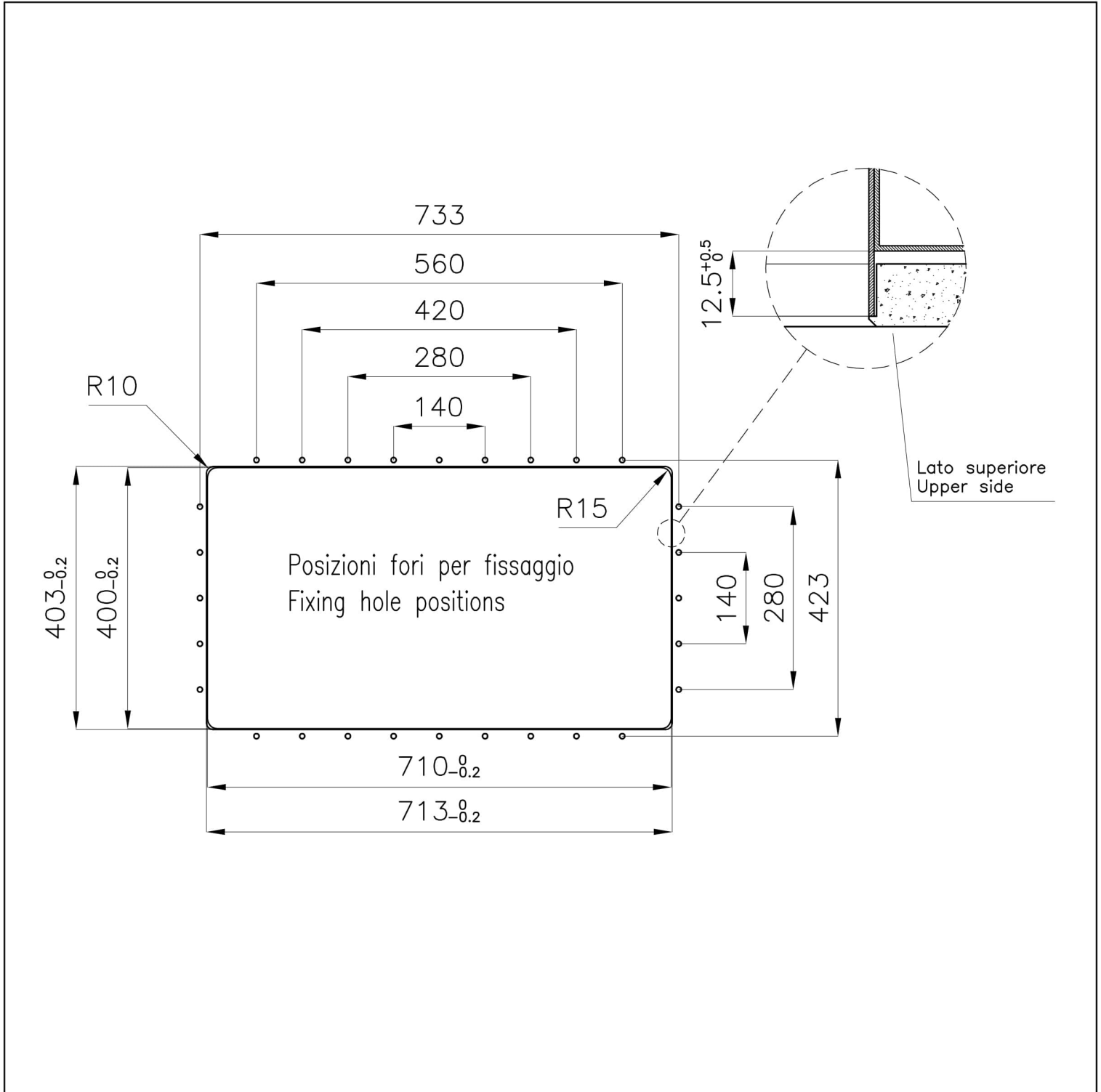

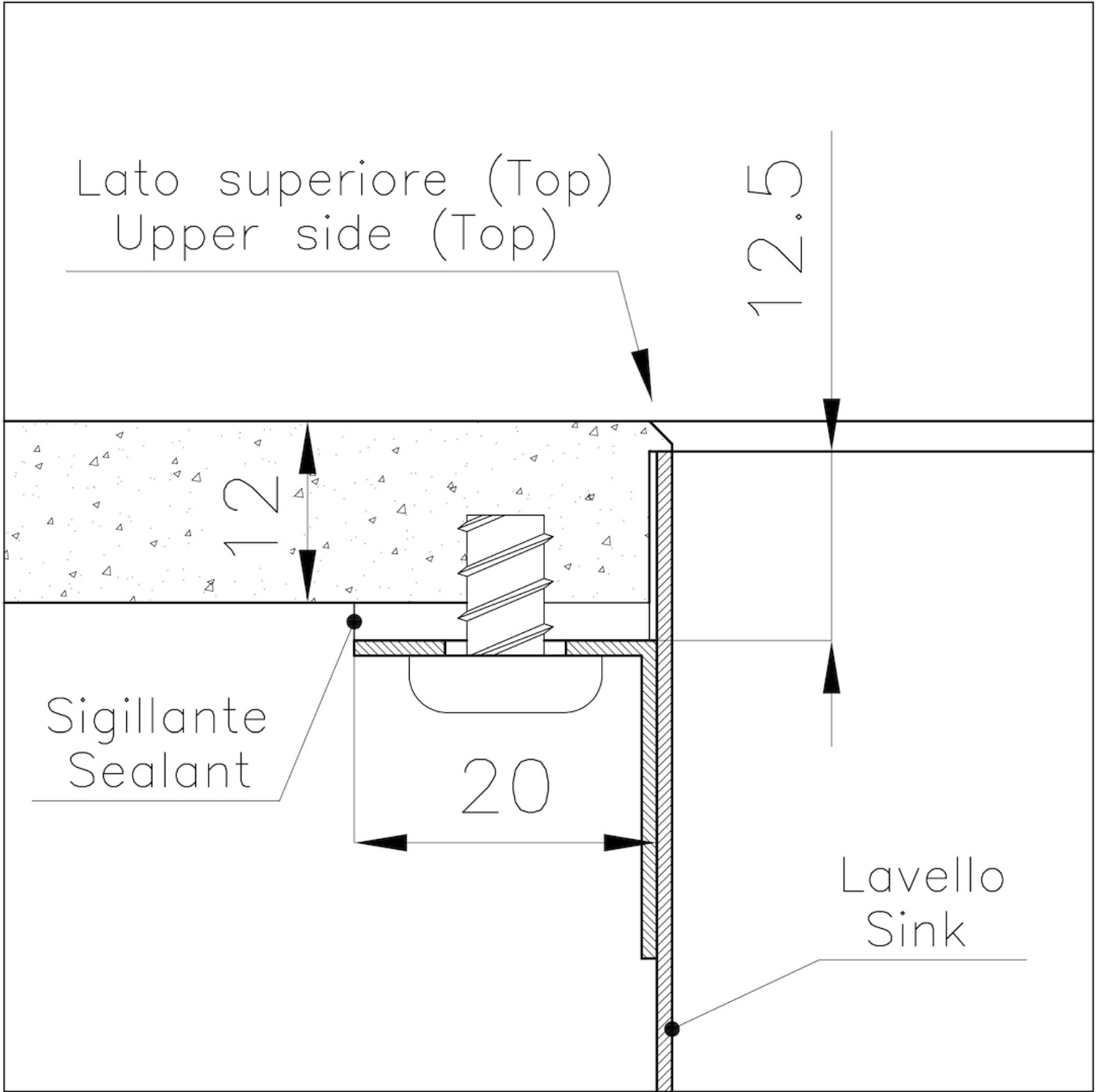

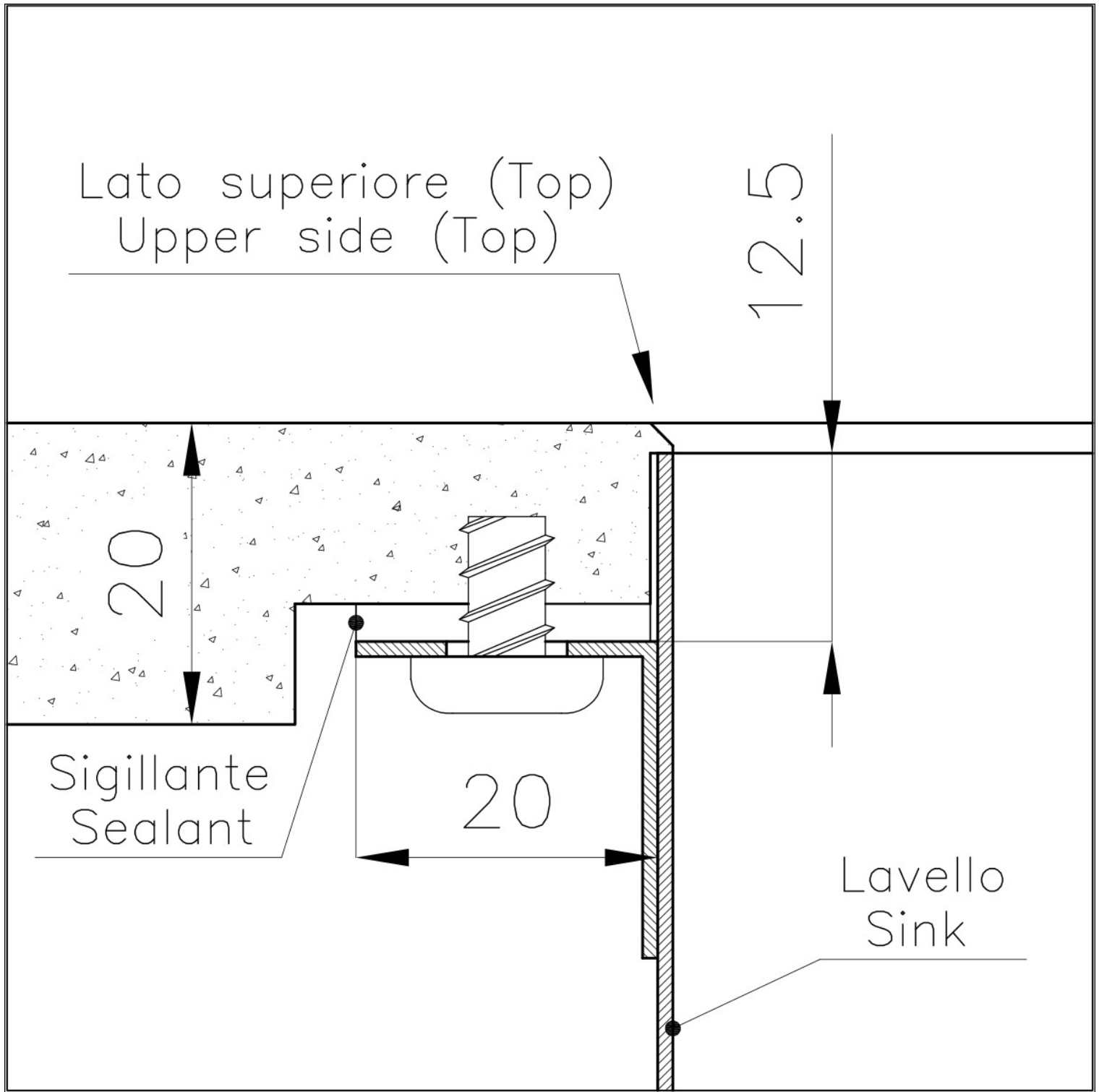

GALLERY

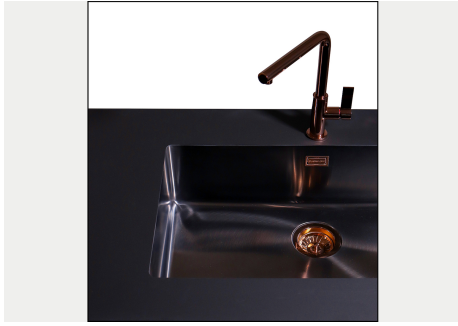

OPTIONAL ACCESSORIES



HPDE Twin chopping board 8644 101

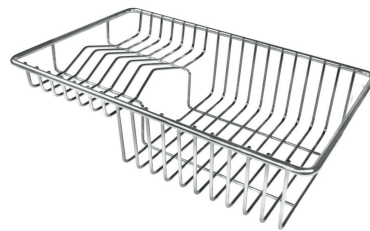

Stainless steel plate rack 8100 303



Glass chopping board 8631 300



Graters kit with ring-holder and food collection tray 8159 101



HPDE Chopping board 8657 001



Iroko-wood chopping board with stainless steel colander 8644 042



Iroko-wood sliding chopping board 8644 041



Iroko-wood twin chopping board 8644 004



Stainless steel colander 8154 000



Stainless steel perforated tray 8151 000



Stainless steel plate rack 8100 154

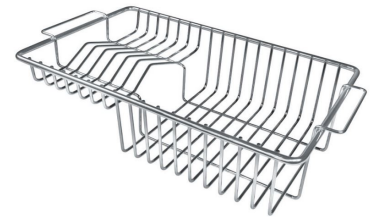

Stainless steel plate rack 8100 201



White basket 8612 100



White bowl 8153 100

WARNING:

The accessories 8159101, 8100303,8151000 are only usable in combination with 8644101

RECOMMENDED PAIRINGS



Mixer Tap FL 8521 000



Mixer Tap Omega 8497 000



Mixer Tap Omega Gun Metal
8497 856



Mixer Tap Omega Plus 8497 020



Mixer Tap Omega Plus Gun Metal
8498 856

OPTIONAL AUTOMATIC WASTE FITTINGS



Automatic waste fitting 8407 113



Gun Metal automatic waste
fitting 8407 110