

Features

- Molded lumbar support and armrests offer extra comfort while bathing.
- Integral apron.
- Integral flange helps prevent water from seeping behind wall and simplifies alcove installation.
- Textured bottom surface.
- Coordinates with other products in the Devonshire collection.

Material

- Acrylic.

Installation

- Left drain.
- Alcove.

Recommended Products/Accessories

- K-7161-AF 1-1/2" adjustable pop-up drain above- or through-floor
- K-7213 27" Cable Bath Drain
- K-7214 27" Cable Bath Drain
- K-7259 Clearflo Bath Drain
- K-37380 30" Rough-in Cable Bath Drain
- K-37383 Rough-in cable bath drain, PVC, 30" cable with tubing
- K-702200-G54 Frameless Sliding Bath Door
- K-702200-G73 Frameless Sliding Bath Door
- K-702200-L Frameless Sliding Bath Door
- K-702205-L Frameless Sliding Bath Door
- K-706000-D3 Frameless Sliding Bath Door
- K-706000-L Frameless Sliding Bath Door
- K-706003-L Frameless Sliding Bath Door
- K-706004-D3 Frameless Sliding Bath Door
- K-706004-L Frameless Sliding Bath Door
- K-706007-L Frameless Sliding Bath Door
- K-23726 Drain treatment
- K-23732 Tub & shower cleaner



Codes/Standards







CSA B45.5/IAPMO Z124

KOHLER® Plastic Baths and Receptors Lifetime Limited Warranty

See website for detailed warranty information.

Available Colors/Finishes

Color tiles intended for reference only.

Color	Code	Description
	0	White
	96	Biscuit
	47	Almond
	NY	Dune
	G9	Sandbar
	58	Thunder™ Grey

No change in measurements if connected with drain illustrated. (K-7161-AF)

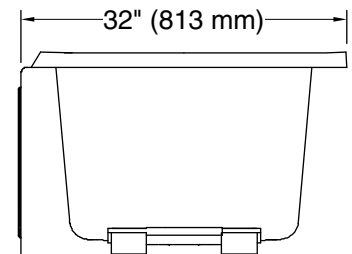
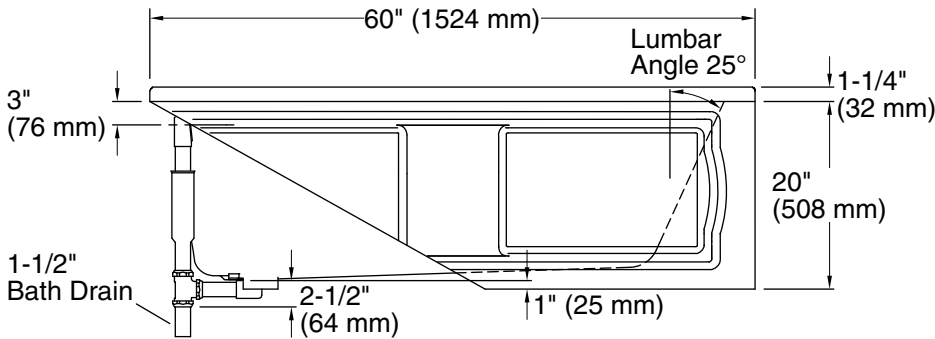
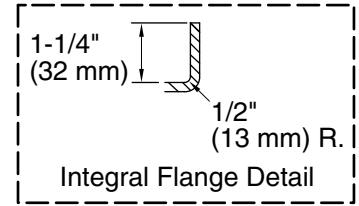
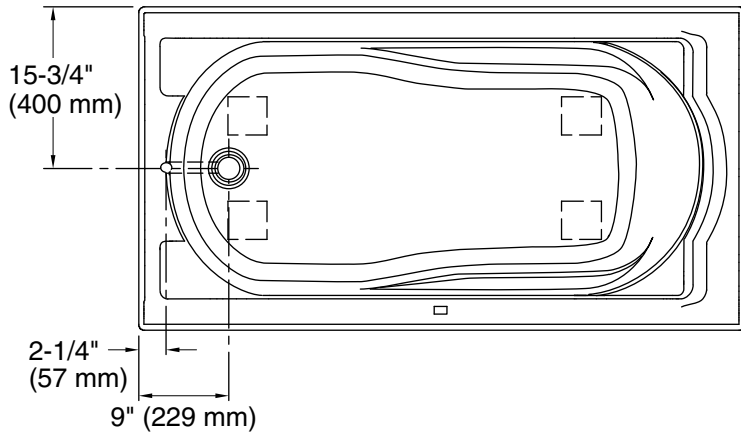

Technical Information

All product dimensions are nominal.

Installation:	Three-wall alcove
Drain location:	Left
Basin area, bottom:	42" x 20" (1067 mm x 508 mm)
Basin area, top:	51" x 24" (1295 mm x 610 mm)
Weight:	80 lbs (36.3 kg)
Minimum floor load:	41 lbs/ft ² (200.2 kg/m ²)
Water depth:	14" (356 mm)
Water capacity:	60 gal (227.1 L)
Minimum flat for door:	2-1/2" (64 mm)

Notes

Measure your actual product for rough-in details. Install this product according to the installation instructions. The hot water supply should be 70% of the capacity of the bath or greater. Installations will vary.