

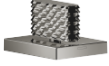





CL.1 Deck valve clockwise closing cold - Dark Chrome

CL.1

20 006 705



- with CASCADE structure
- hole diameter 32 mm
- rosette 60 x 47 mm
- with cold marking
- WRAS 240202020

	Dark Chrome	20 006 705-19
	Chrome	20 006 705-00
	Brushed Platinum	20 006 705-06
	Brushed Champagne (22kt Gold)	20 006 705-46
	Champagne (22kt Gold)	20 006 705-47
	Brushed Dark Platinum	20 006 705-99

20 006 705

mm [inches]

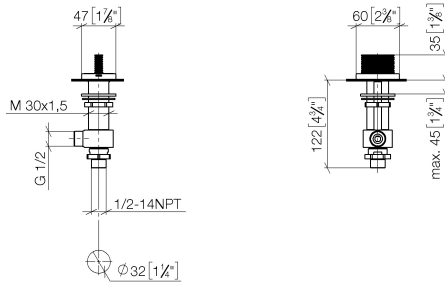

Flow rate chart

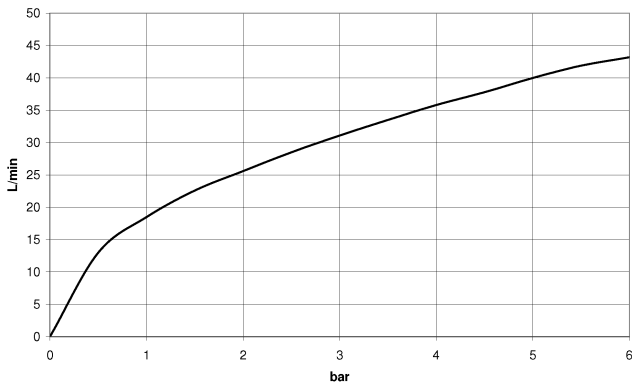

Codes & Standards

DIN 4109

ISO 3822

NSF372

NSF61

Scottish Water
Byelaws

UK Water Supply
Regulations

Ü-Zeichen



CL.1 Deck valve clockwise closing cold - Dark Chrome

CL.1

20 006 705

Certificates

WRAS_240202

IAPMO_N-4

LGA_28

IAPMO_6

20 006 705

Product version from 3/9/2015

Parts for other finishes can be found here: [Chrome](#)

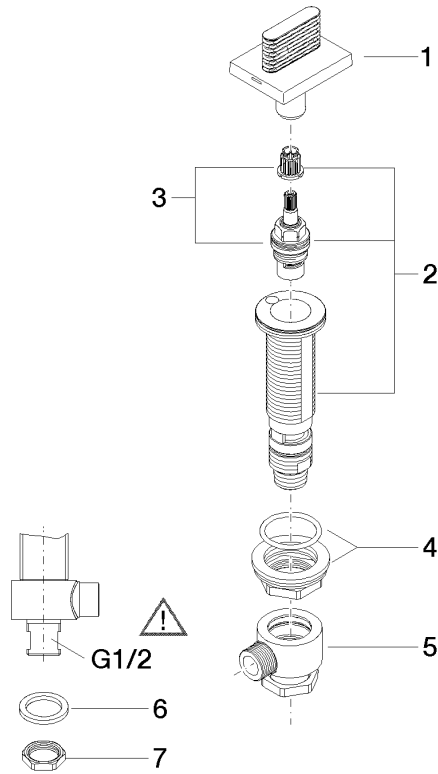



CL.1 Deck valve clockwise closing cold - Dark Chrome

CL.1

20 006 705

Spare parts list

Product version from 3/9/2015

No.	Item Number	Name	Quantity used	Delivery time
	90 20 70 053 06-19	handle (cold)	8	20