





A		5mm	1	B		M8*25	36
C		8*17*1.2	36	D		∅22*7+M6*10	4
E			16	F			

FIG.
1

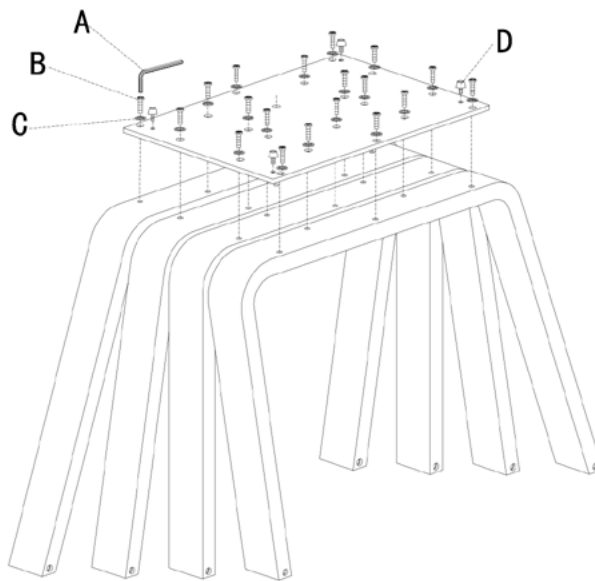

FIG.
2

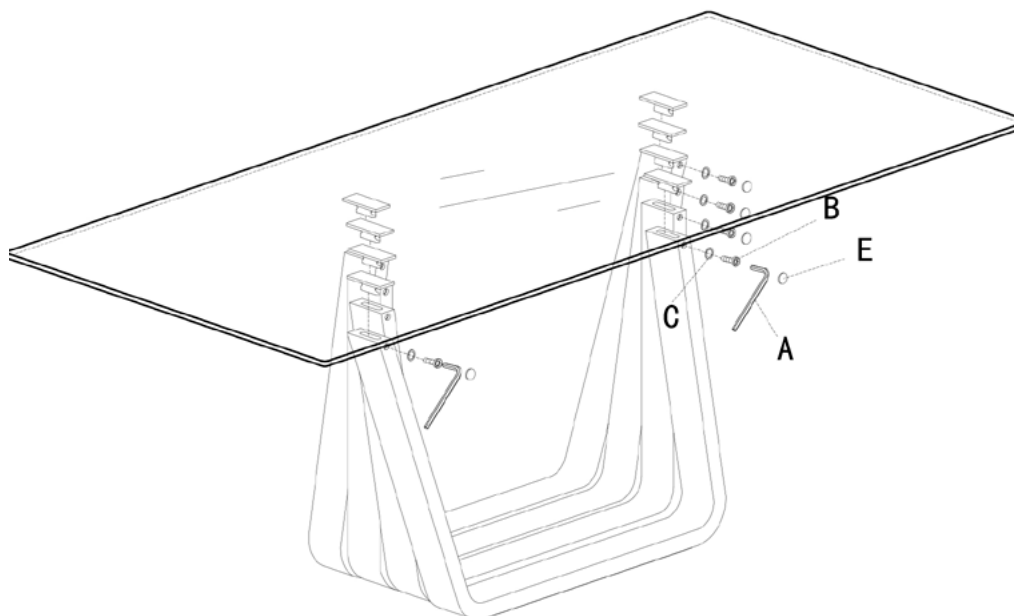

FIG.
3

