



DANIEL

SCHEDA TECNICA TECHNICAL FEATURES

ART. COD.

A230

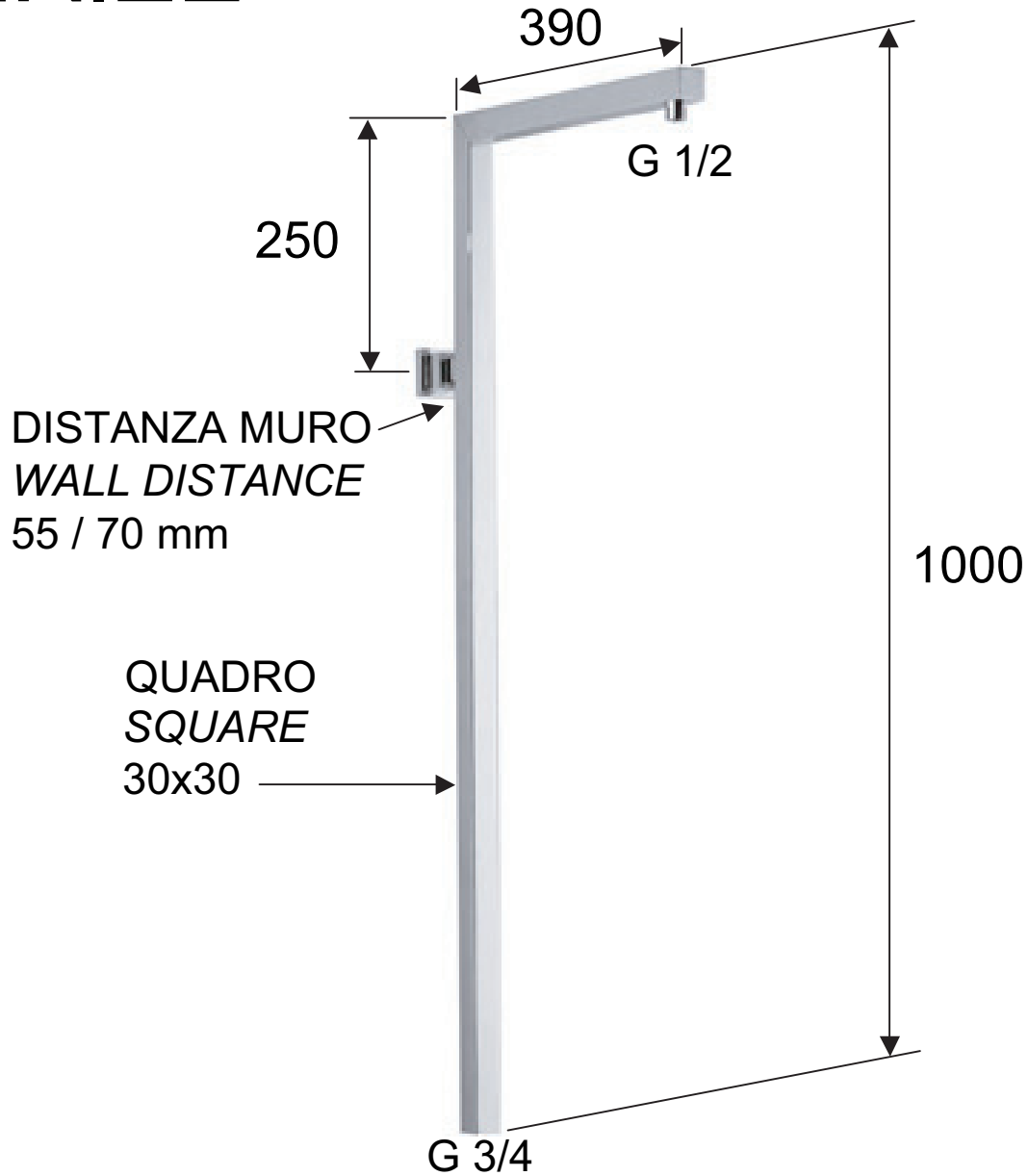

MATERIALI / MATERIALS

OTTONE CROMATO / CHROME PLATED BRASS

CROMATURA / CHROME PLATING

UNI EN 248