

7 642 00 / 01 / 02 / 03

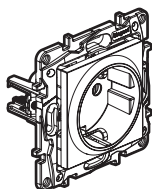

7 642 10 / 11 / 12 / 13

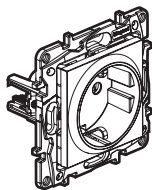

7 642 20 / 21 / 22 / 23

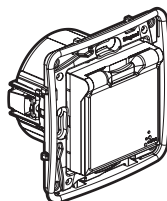

7 642 40 / 41 / 42 / 43

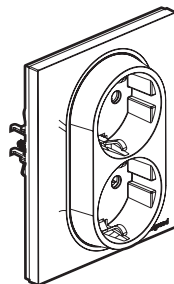

7 642 30 / 31 / 32 / 33

7 642 00 / 01 / 02 / 03

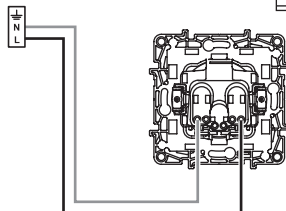
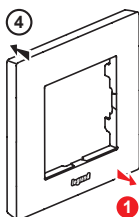
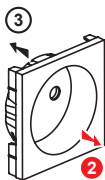
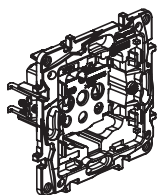

16 A - 250 V~
 ≤ 2,5 mm²
 9 mm

7 642 10 / 11 / 12 / 13

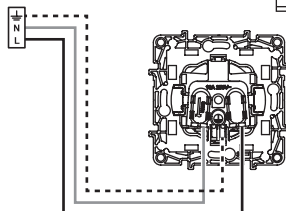
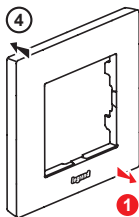
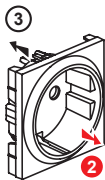
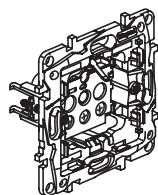

16 A - 250 V~
 ≤ 2,5 mm²
 9 mm

7 642 20 / 21 / 22 / 23

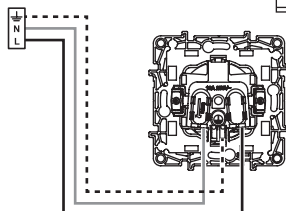
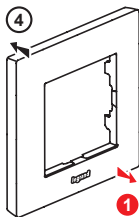
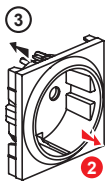
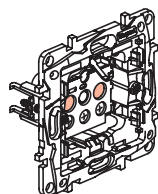

16 A - 250 V~
 ≤ 2,5 mm²
 9 mm

7 642 40 / 41 / 42 / 43

16 A - 250 V~

 ≤ 2,5 mm²

 9 mm

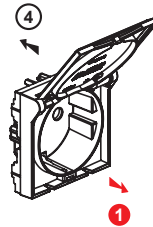
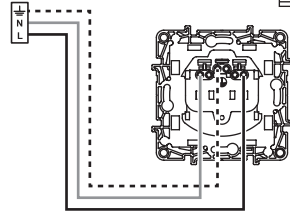
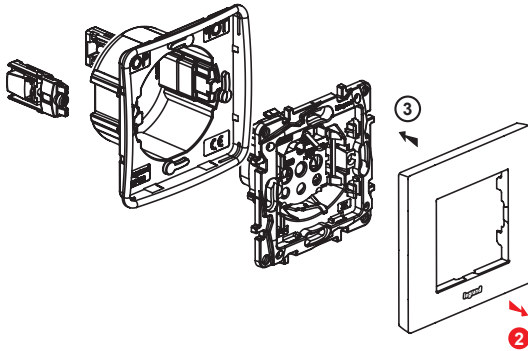

7 642 30 / 31 / 32 / 33

16 A - 250 V~

 ≤ 2,5 mm²

 13 mm

