

Pre-installation

Shower tray ARQ

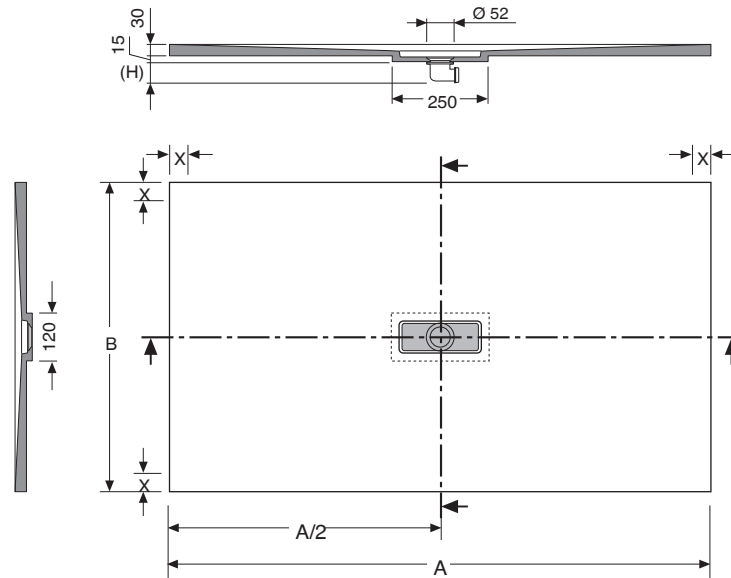

A	B	V	P
1000	700	0,063	38
1010 → 1100	700	0,071	42
1110 → 1200	700	0,075	46
1210 → 1300	700	0,083	50
1310 → 1400	700	0,087	54
1410 → 1500	700	0,094	57
1510 → 1600	700	0,102	62
1610 → 1700	700	0,106	65
1710 → 1800	700	0,114	69
1810 → 1900	700	0,118	72
1910 → 2000	700	0,139	78

A	B	V	P
1000	750	0,063	40
1010 → 1100	750	0,071	45
1110 → 1200	750	0,075	50
1210 → 1300	750	0,083	53
1310 → 1400	750	0,087	58
1410 → 1500	750	0,094	61
1510 → 1600	750	0,102	66
1610 → 1700	750	0,106	70
1710 → 1800	750	0,114	75
1810 → 1900	750	0,118	78
1910 → 2000	750	0,139	84

A	B	V	P
1000	800	0,063	43
1010 → 1100	800	0,071	48
1110 → 1200	800	0,075	53
1210 → 1300	800	0,083	57
1310 → 1400	800	0,087	62
1410 → 1500	800	0,094	66
1510 → 1600	800	0,102	71
1610 → 1700	800	0,106	75
1710 → 1800	800	0,114	80
1810 → 1900	800	0,118	83
1910 → 2000	800	0,139	89

A	B	V	P
1000	900	0,079	49
1010 → 1100	900	0,089	55
1110 → 1200	900	0,094	60
1210 → 1300	900	0,104	65
1310 → 1400	900	0,109	70
1410 → 1500	900	0,119	74
1510 → 1600	900	0,124	80
1610 → 1700	900	0,134	84
1710 → 1800	900	0,139	90
1810 → 1900	900	0,139	94
1910 → 2000	900	0,139	99

A	B	V	P
1000	1000	0,079	53
1010 → 1100	1000	0,089	60
1110 → 1200	1000	0,094	66
1210 → 1300	1000	0,104	71
1310 → 1400	1000	0,109	77
1410 → 1500	1000	0,119	81
1510 → 1600	1000	0,124	87
1610 → 1700	1000	0,134	92
1710 → 1800	1000	0,139	98
1810 → 1900	1000	0,139	103
1910 → 2000	1000	0,139	108

A	B	V	P
1000	1100	0,079	62
1010 → 1100	1100	0,089	69
1110 → 1200	1100	0,094	75
1210 → 1300	1100	0,104	80
1310 → 1400	1100	0,109	86
1410 → 1500	1100	0,119	90
1510 → 1600	1100	0,124	96
1610 → 1700	1100	0,134	101
1710 → 1800	1100	0,139	107
1810 → 1900	1100	0,139	111
1910 → 2000	1100	0,139	118

A	B	V	P
1300	1300	0,148	116
1310 → 1400	1300	0,159	126
1410 → 1500	1300	0,170	137
1510 → 1600	1300	0,181	147
1610 → 1700	1300	0,191	153
1710 → 1800	1300	0,202	164
1810 → 1900	1300	0,213	174

A	B	V	P
1300	1400	0,159	127
1310 → 1400	1400	0,174	138
1410 → 1500	1400	0,182	148
1510 → 1600	1400	0,194	160
1610 → 1700	1400	0,206	167
1710 → 1800	1400	0,217	178
1810 → 1900	1400	0,229	189

Units: mm / V: m³ / P: Kg

(H) Height according to valve supplied

X Glass enclosure zone. The minimum area reserved for the glass enclosure is 30mm

Installation

SHOWER TRAY ARQ

1

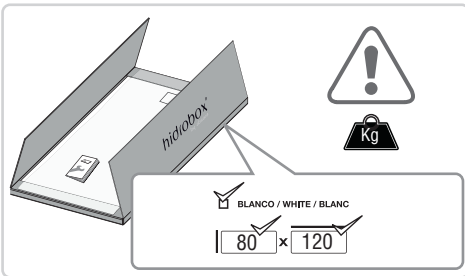

2

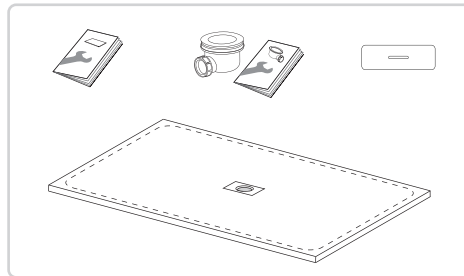

3

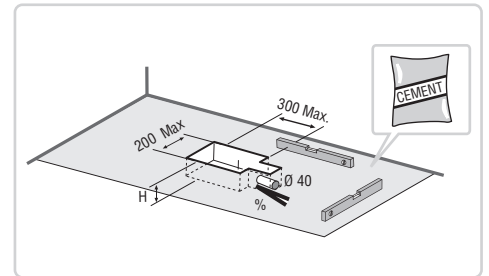

4

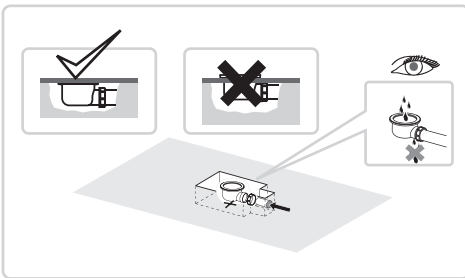

5

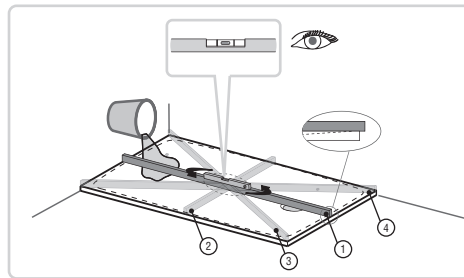

6

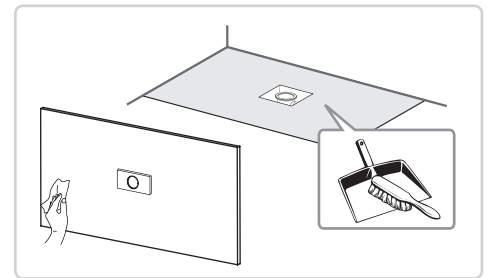

7.1 OPTION (A)

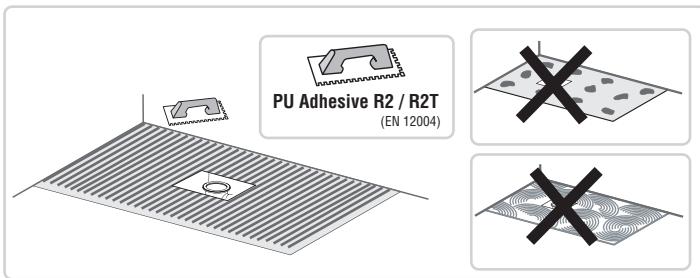

7.2 OPTION (B)

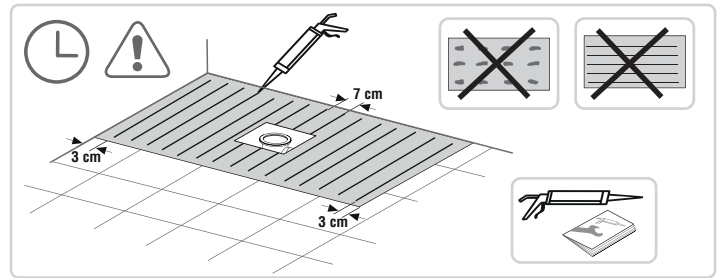

7.3 OPTION (C)

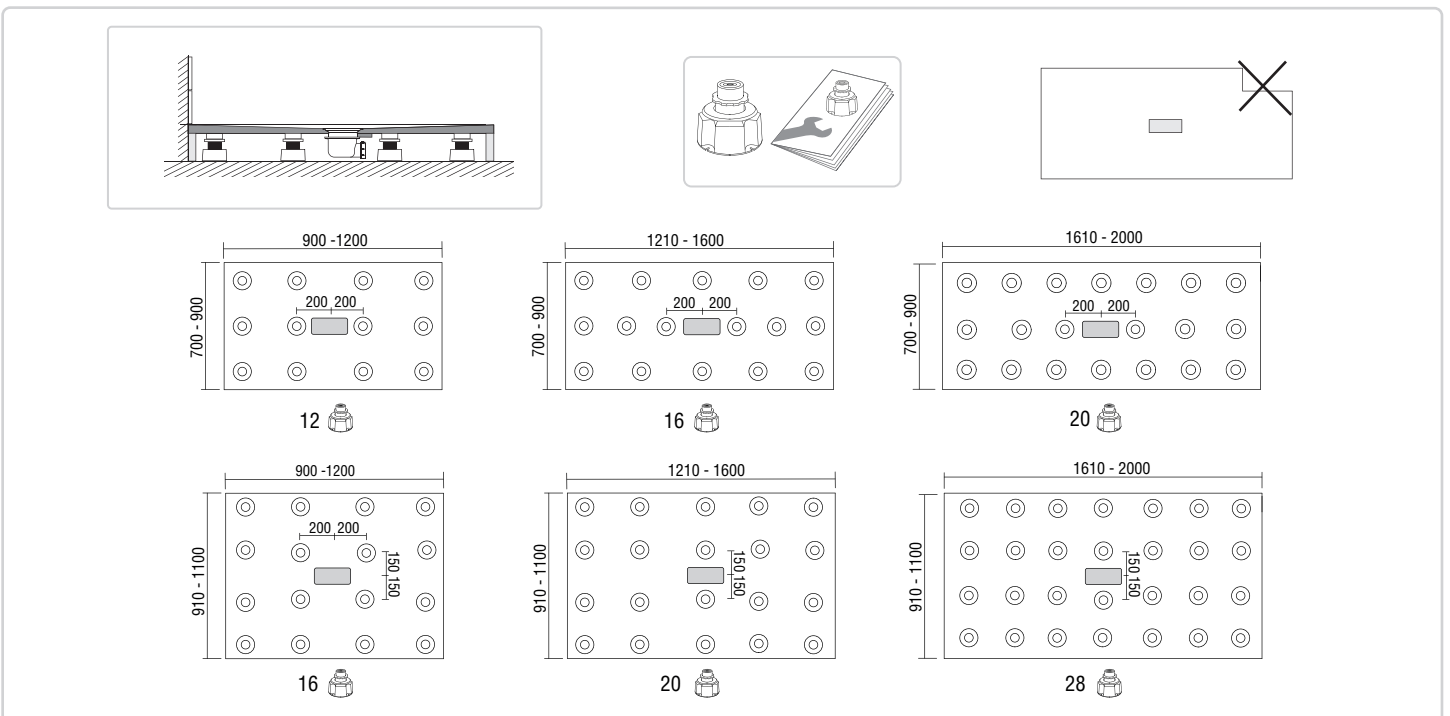

Installation

SHOWER TRAY ARQ

8

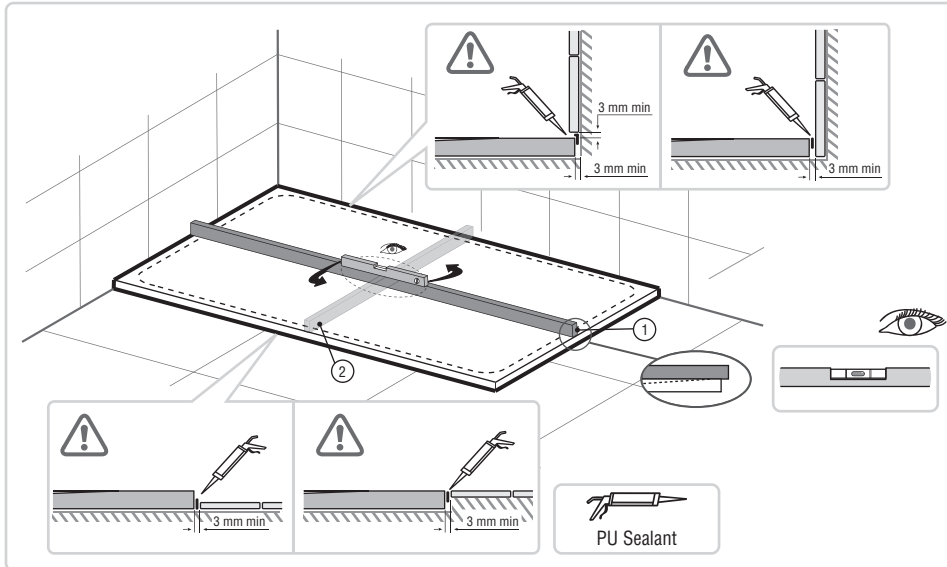

9

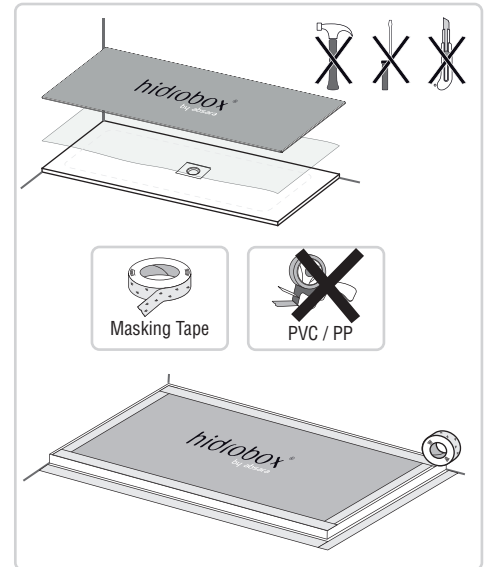

10

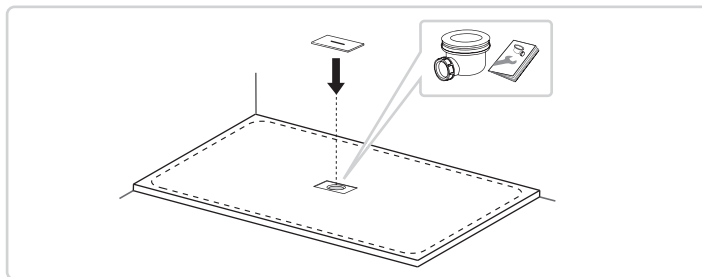

11

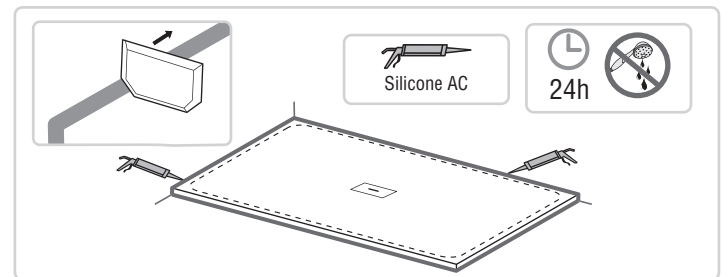

Adhesives and others (supplied by hidrobox)



Two-component polyurethane adhesive R2 or R2T
Cube of 5KG or 10KG White



MS Adhesive for installation in cords
300 ml cartridge



Silicone sealant
310 ml cartridge



Feet
Pack of 4 pieces for installation on feet