



Roca

ROCA BOX UNIVERSAL SINGLE LEVER MIXER

L-90



A5A2B01



A5A0B01

THESIS



A5A2B50



A5A0B50

ESMAI



A5A2B31



A5A0B31

ATLAS



A5A2B90



A5A0B90

INSIGNIA



A5A2B3A



A5A0B3A

LANTA



A5A2B11



A5A0B11

M2



A5A2B68



A5A0B68

NAIA



A5A2B96



A5A0B96

LOGICA



A5A2B27



A5A0B27

L90

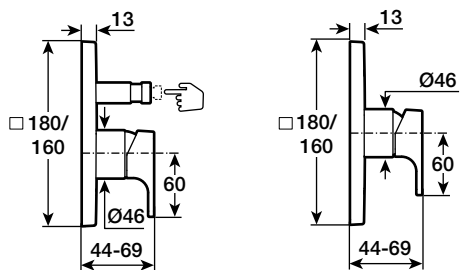

THESIS

[mm]

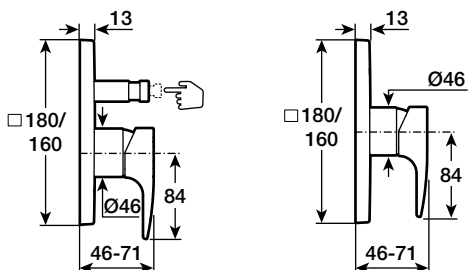

ESMAI

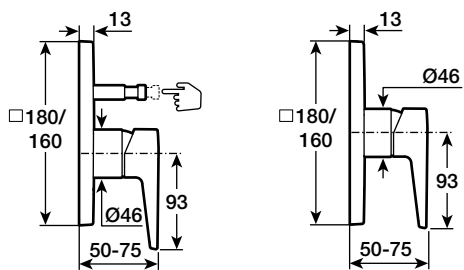

ATLAS

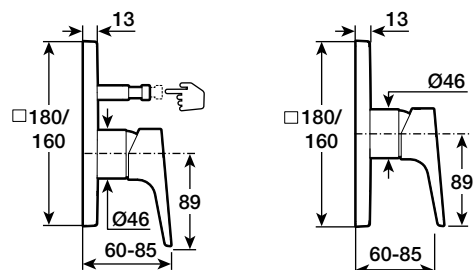

INSIGNIA

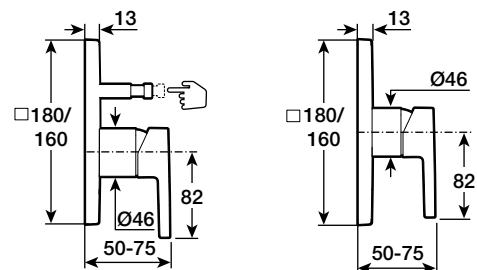

LANTA

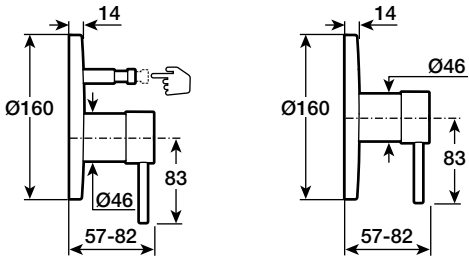

M2

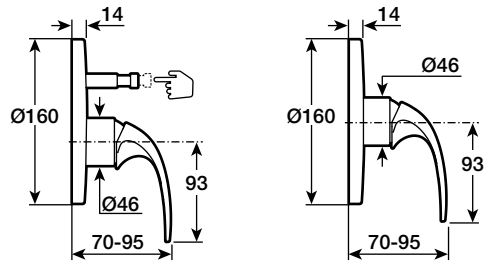



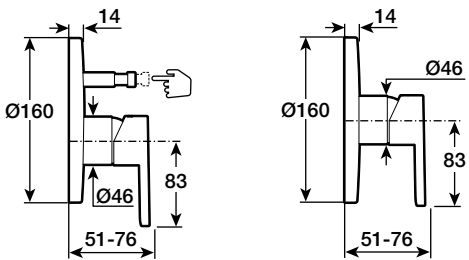



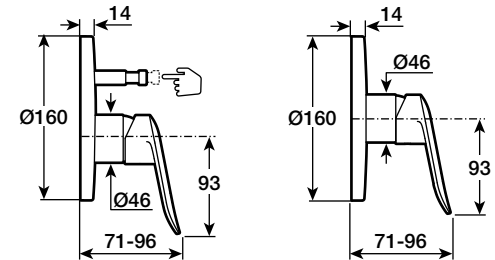

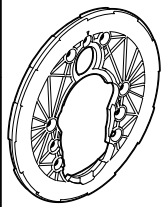
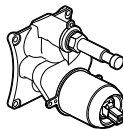
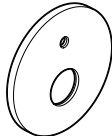
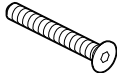
NAIA

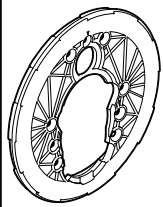
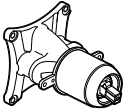
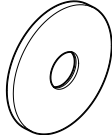
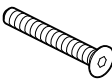

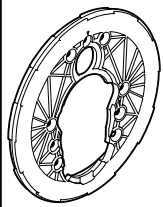
LOGICA





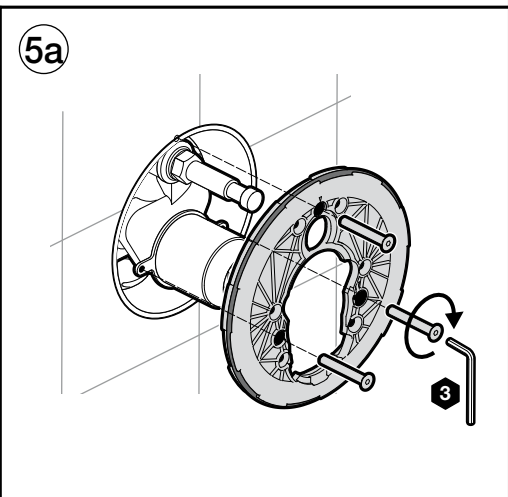
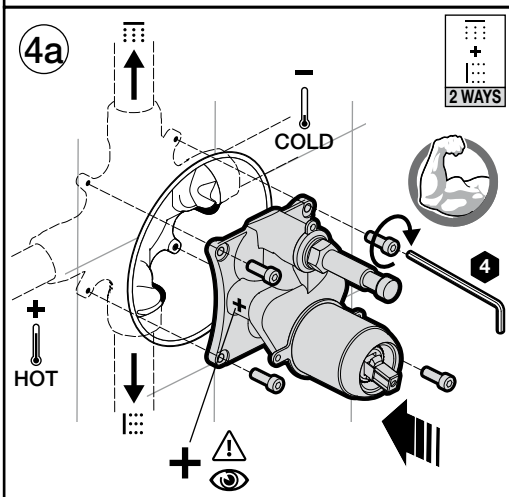
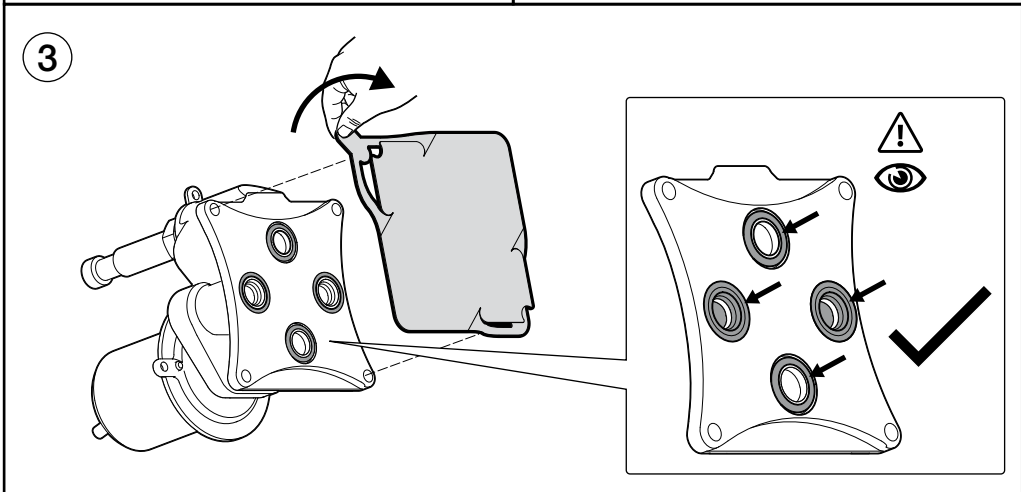
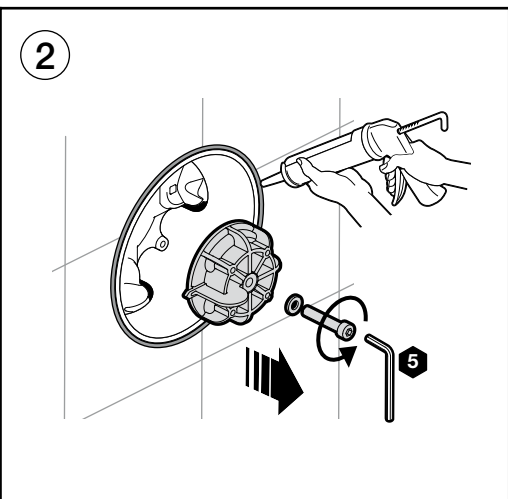
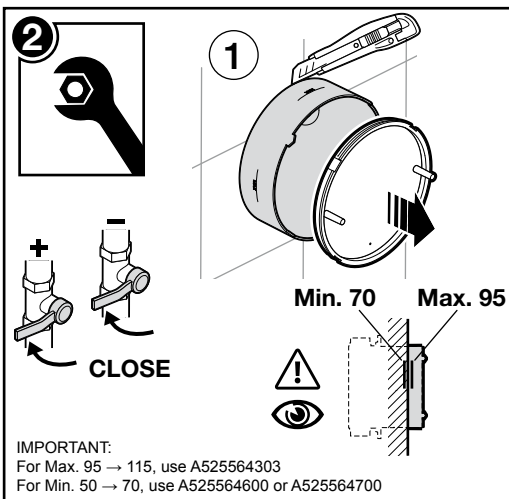

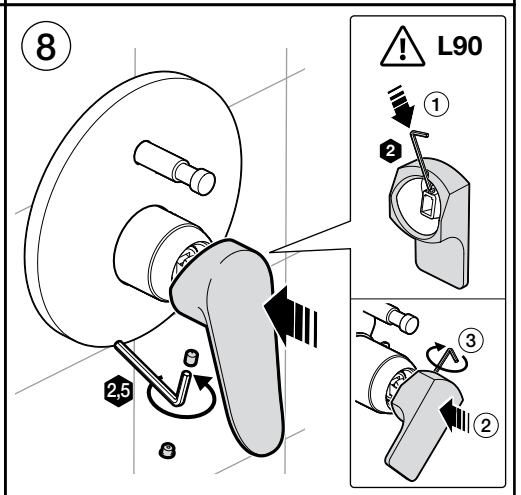
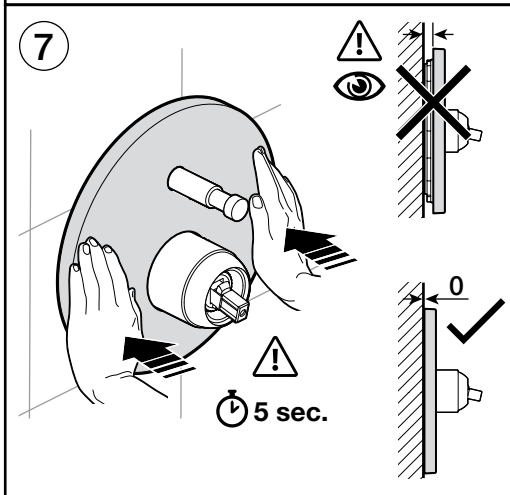
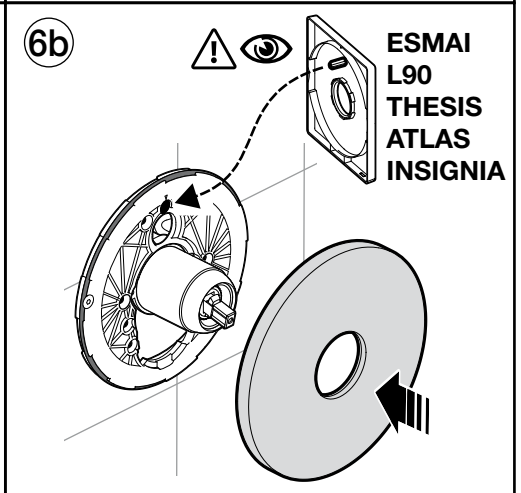
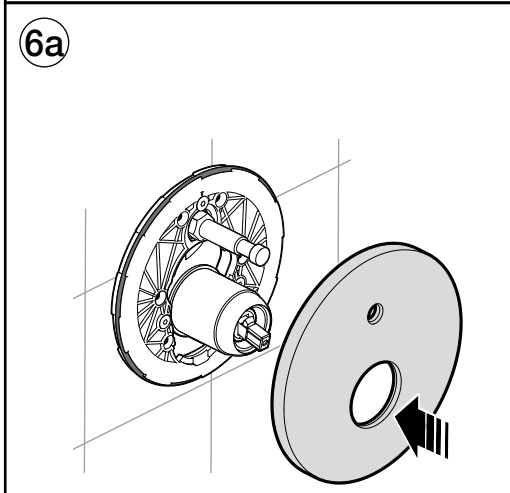
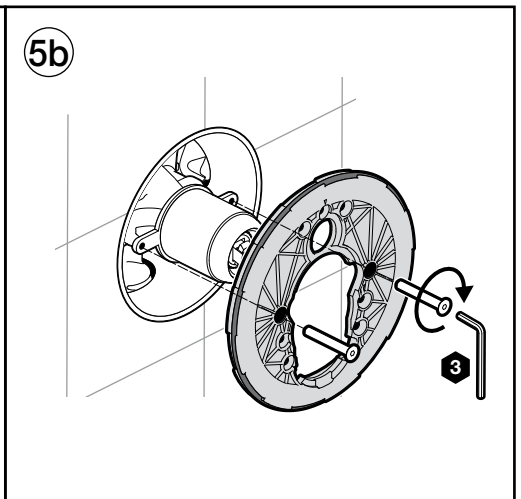
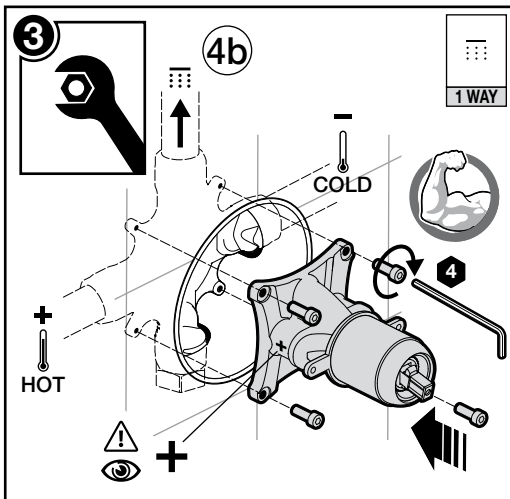

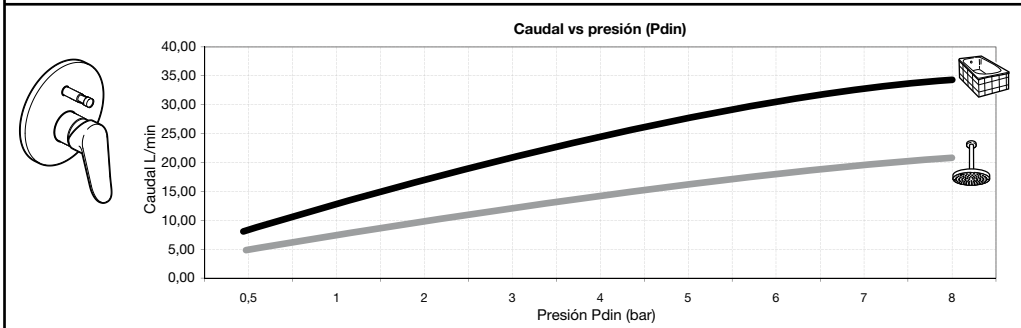
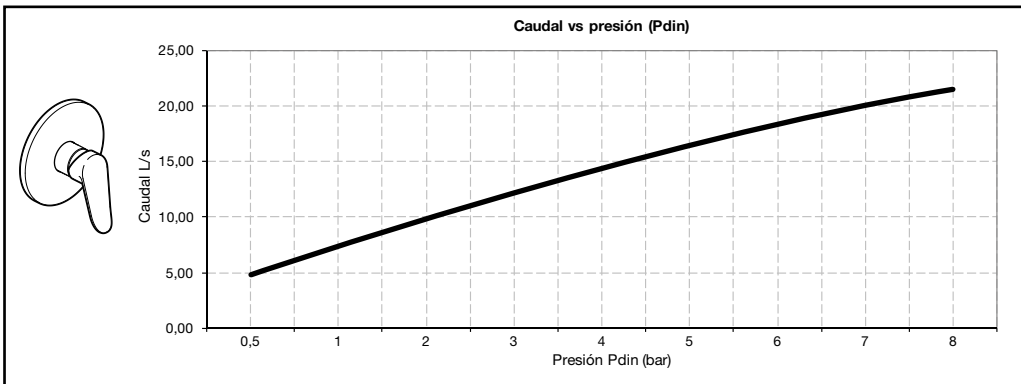
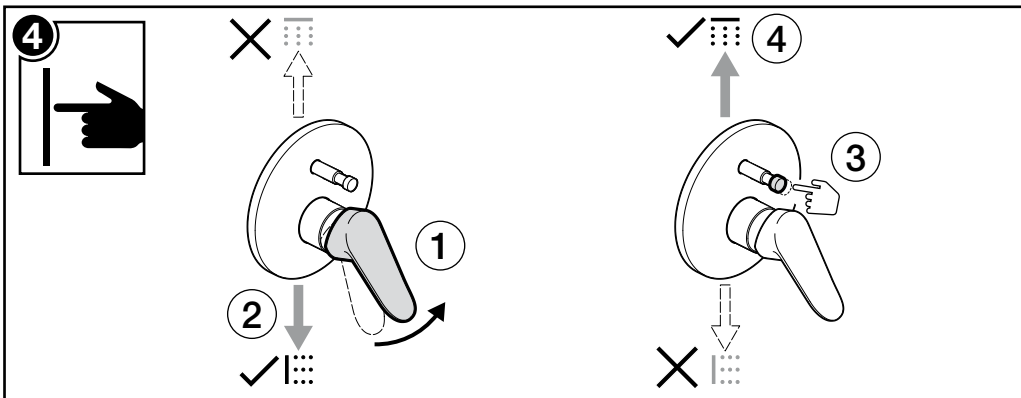



a				
 x1	 x1	 x3		
b				
 x1	 x1	 x2		
 x1	 x1	 x1		







 P 	P bar	 MAX 10
 P 	P bar	MIN 1  5 MAX
  T	°C	 80 MAX.
		 -65 -50 



A5A0B01	L90
A5A0B50	THESIS
A5A0B31	ESMAI
A5A0B11	LANTA
A5A0B68	M2
A5A0B27	LOGICA
A5A0B90	ATLAS
A5A0B96	NAIA

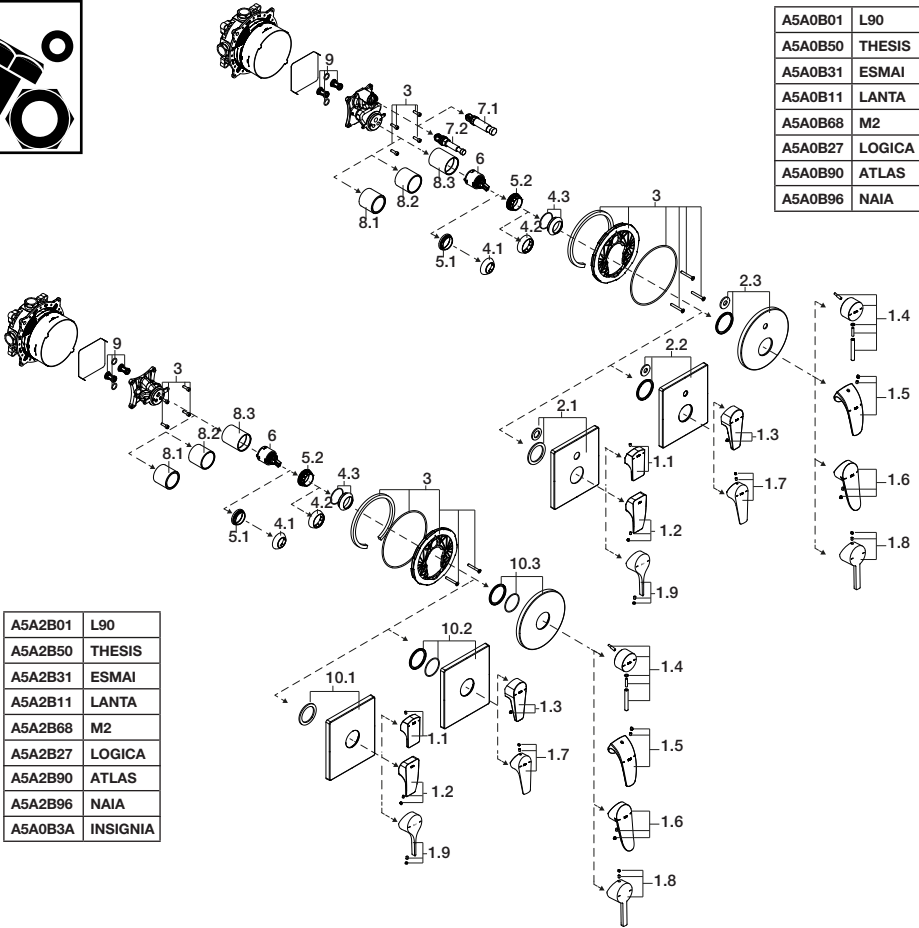

A5A2B01	L90
A5A2B50	THESIS
A5A2B31	ESMAI
A5A2B11	LANTA
A5A2B68	M2
A5A2B27	LOGICA
A5A2B90	ATLAS
A5A2B96	NAIA
A5A0B3A	INSIGNIA

1.1	- AG00418..R	L90
1.2	- A5250226..	THESIS
1.3	- A5250296..	ESMAI
1.4	- AG01214..R	LANTA
1.5	- AG00369..R	M2
1.6	- AG00181..R	LOGICA
1.7	- AG001163..R	ATLAS
1.8	- AG01269..R	NAIA
1.9	- AG01542..R	INSIGNIA
2.1	- AG01219..R	L90 THESIS INSIGNIA
2.2	- AG01211..R	ESMAI ATLAS LANTA
2.3	- AG01213..R	M2 LOGICA NAIA
3	- AG0120900R	L90
4.1	- AG00321..R	M2 THESIS ESMAI LOGICA ATLAS NAIA INSIGNIA
4.2	- AG00853..R	THESIS ESMAI LOGICA ATLAS NAIA INSIGNIA
4.3	- AG01215..R	LANTA
5.1	- A525027803	L90 M2

5.2	- A525023507	THESIS ESMAI LANTA LOGICA ATLAS NAIA INSIGNIA
6	- AG0110607R	L90
7.1	- A5250228..	THESIS INSIGNIA ESMAI LANTA
7.2	- A5250065..	M2 LOGICA ATLAS NAIA
8.1	- AG01216..R	L90 M2 THESIS ESMAI LOGICA ATLAS NAIA INSIGNIA
8.2	- A5250068..	THESIS ESMAI LOGICA ATLAS NAIA INSIGNIA
8.3	- AG01217..R	LANTA
9	- AG0121000R	L90
10.1	- AG01271..R	THESIS INSIGNIA

10.2	- AG01270..R	ESMAI ATLAS LANTA
10.3	- AG01212..R	M2 LOGICA NAIA

Sustituir (..) de la referencia del recambio por el código del acabado elegido:
In the spare part number replace (..) with the code for the chosen finish:

00 Cromado / Chromed

CN Shiny Black

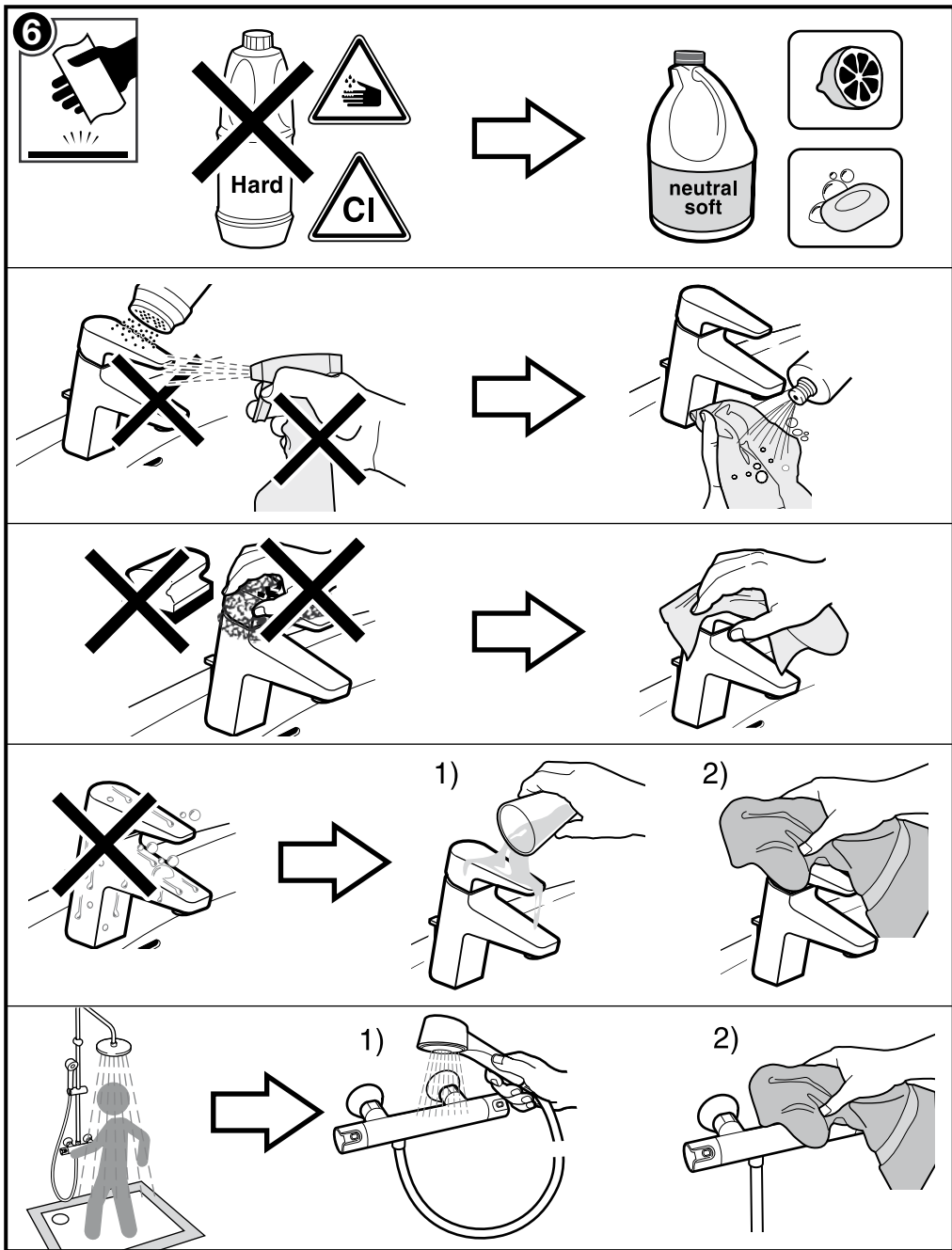

AS23094707n



Roca Sanitario, S.A.
 Avda. Diagonal, 513
 08029 Barcelona
 SPAIN
 www.roca.com

933 LÍNEA DE ATENCIÓN
661 AL CONSUMIDOR
266 ESPAÑA
 SERVICIO TÉCNICO
 ESPAÑA



productsupport.rs@roca.net
 soporteproducto.rs@roca.net