

 **angel cerdá**

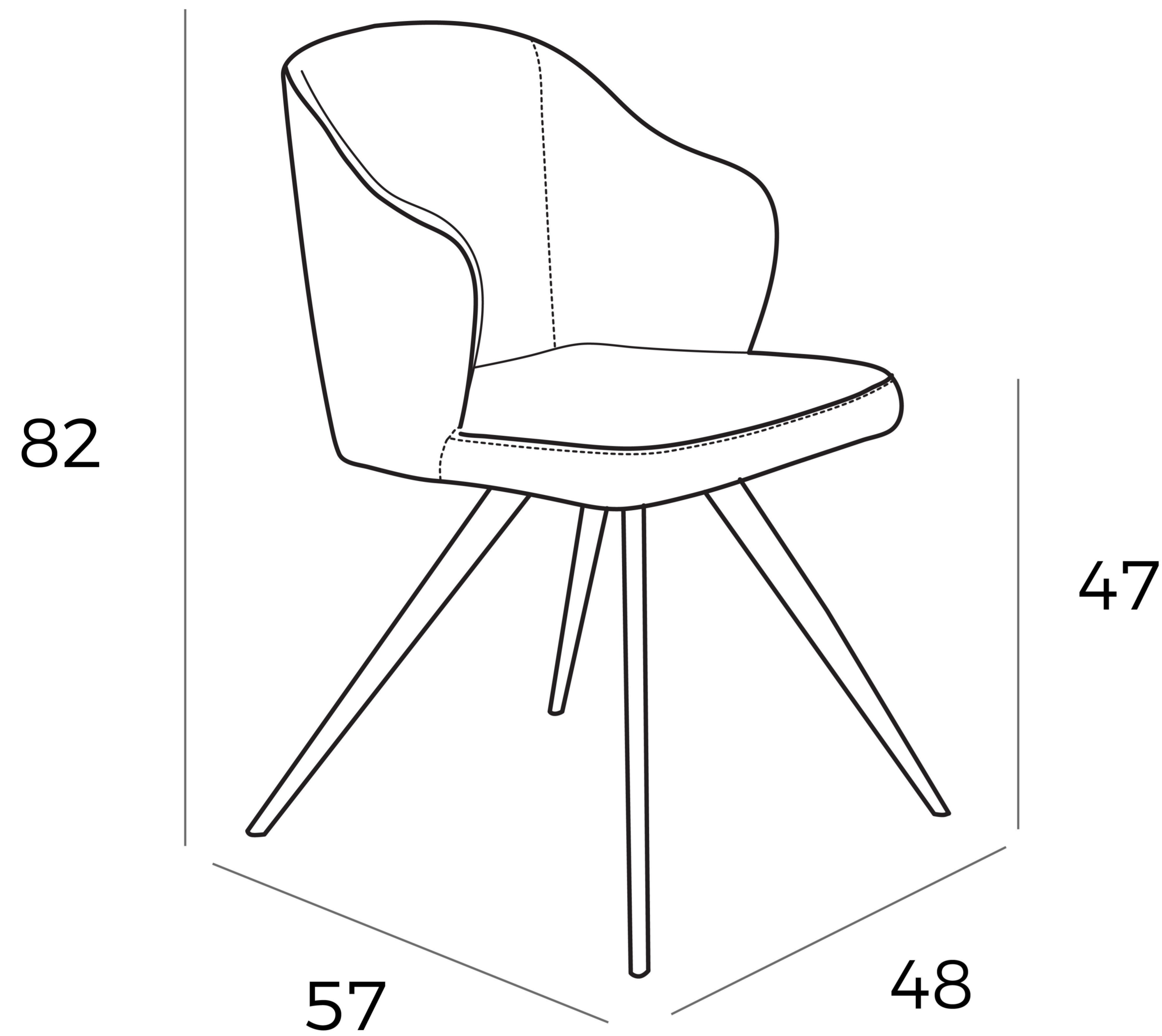



**PACK  
2**

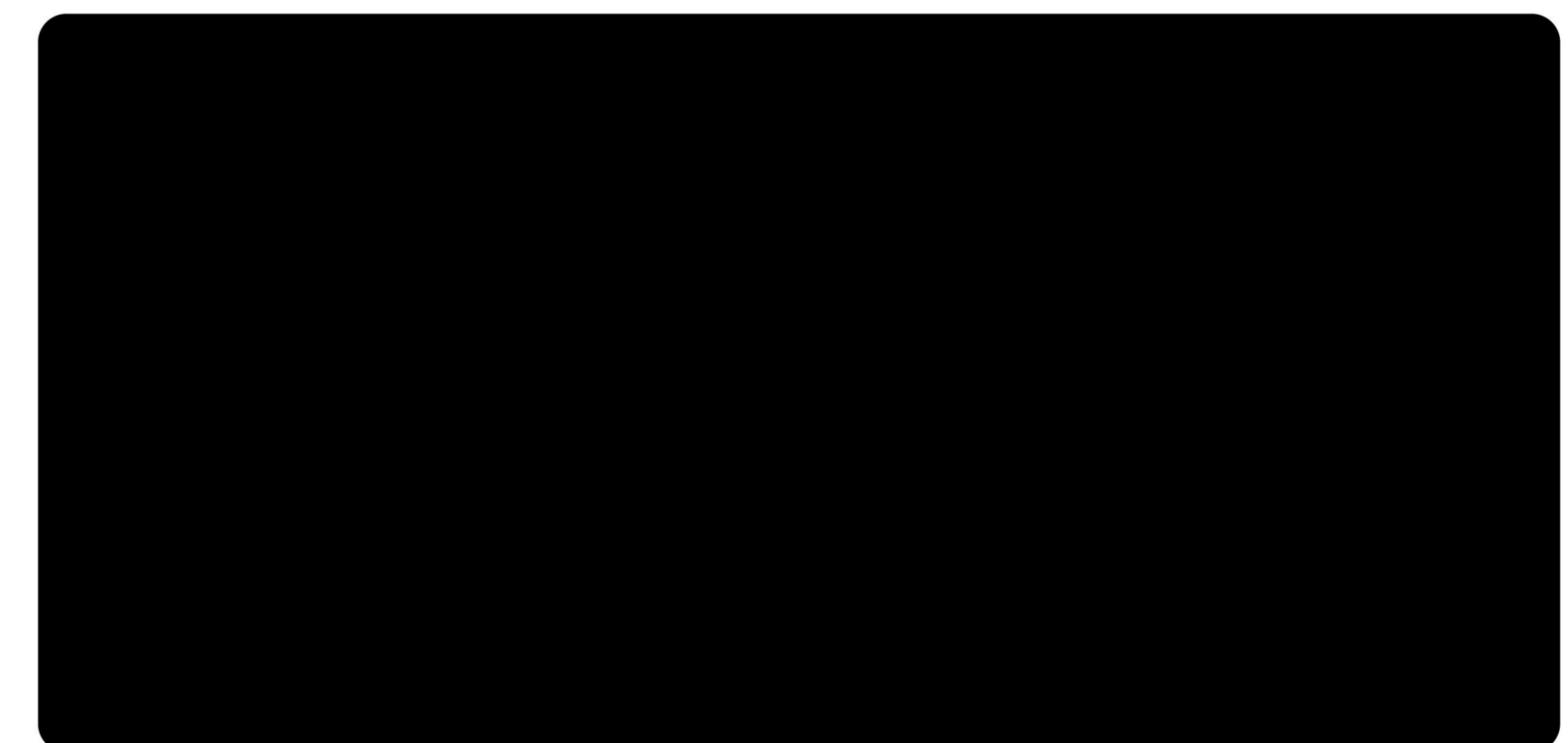

48 x 57 x 82 cm.  
9,5 kg.

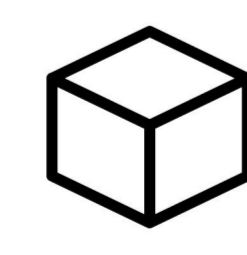

 57 x 52 x 74 cm.  20 kg.