

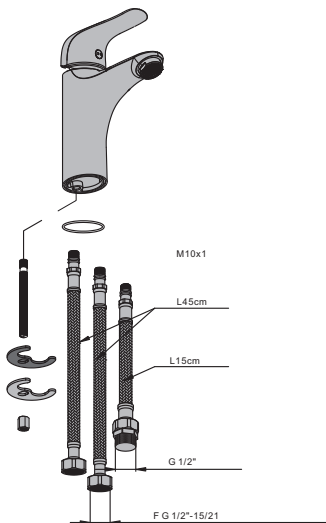

Гарантия  
**5**  
лет\*

SMART



EAN CODE:3276007035322

**RU** Руководство по  
**BY** Эксплуатации

**KZ** Пайдалану жөніндегі  
басшылық

**EN** Instructions Manual

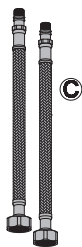
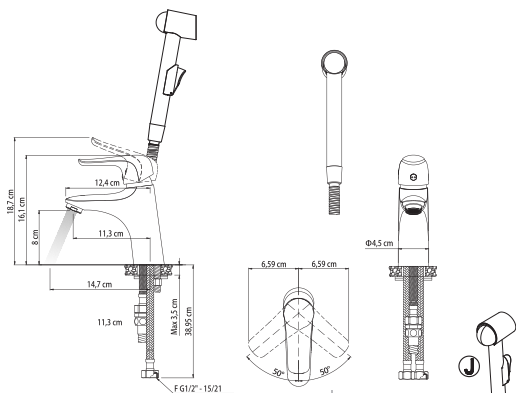

C



D



E

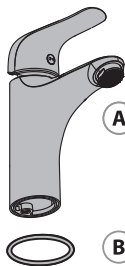

A



B

F



G



H



I



J

K



MIN. 35 mm





**RU/BY:** Подготовка / **KZ:** Дайындау / **EN:** Preparation



4



**RU/BY:** Сборка / **KZ:** Құрастыру / **EN:** Assembly



5 → 8



**RU/BY:** Использование горячей и холодной воды/  
**KZ:** Суық және ыстық суды қолдану / **EN:** Using hot and cold water



9

**RU/BY:** Смена картриджа / **KZ:** Картриджді ауыстыру / **EN:** Replacing the cartridge



10 → 13

**RU/BY:** Смена аэратора / **KZ:** Аэратор ауыстыру / **EN:** Replacing the aerator



14

**RU/BY:** Смена гибкого шланга для смесителя /

**KZ:** Қоспалауышқа арналған иілгіш шлангты ауыстыру / **EN:** Replacing the hoses



15 → 16



RU/ВУ: Подготовка / KZ: Дайындау / EN: Preparation

1

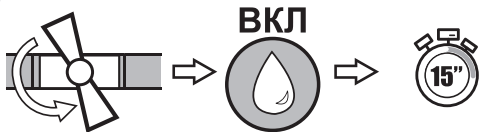

2

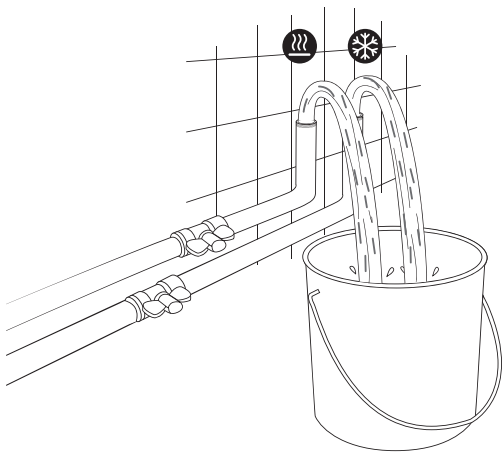

3

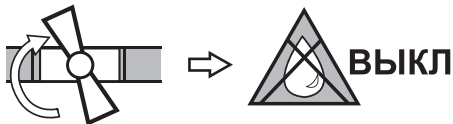



RU/БҮ: Сборка / KZ: Құрастыру / EN: Assembly

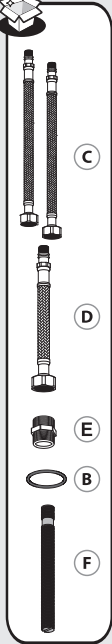
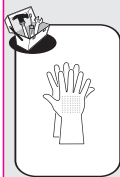

1

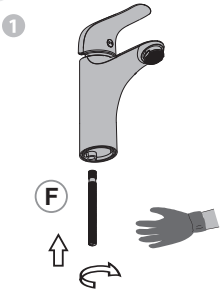

3

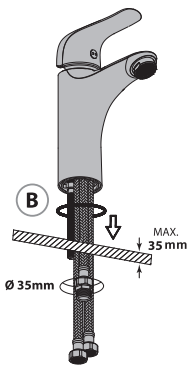

2

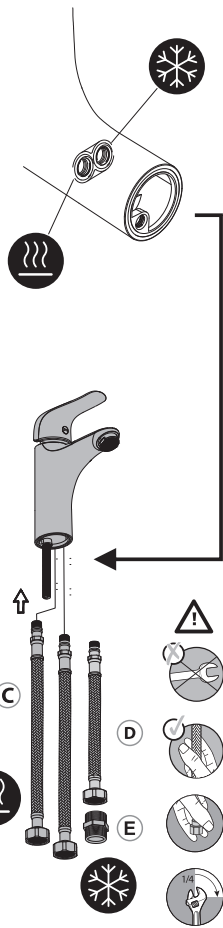



2



G



H



I

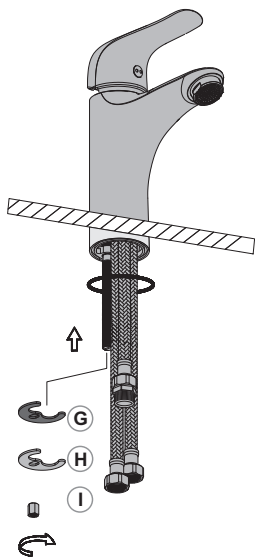

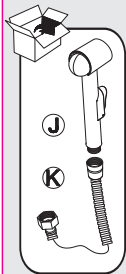

2

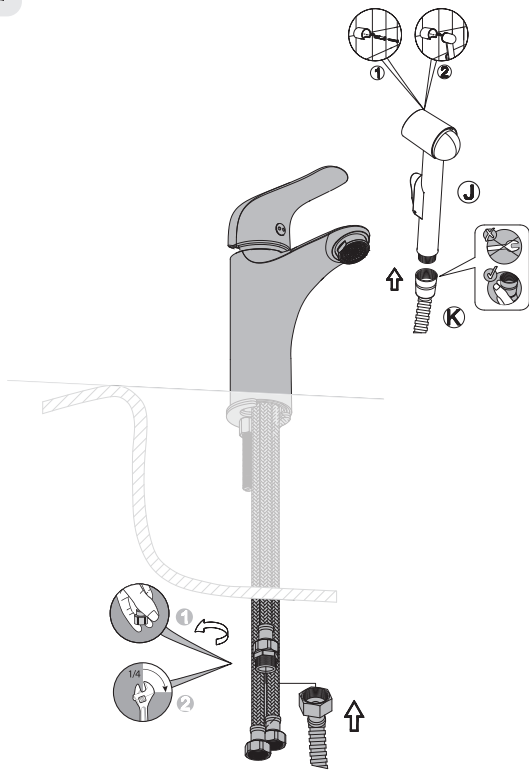

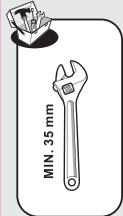

3

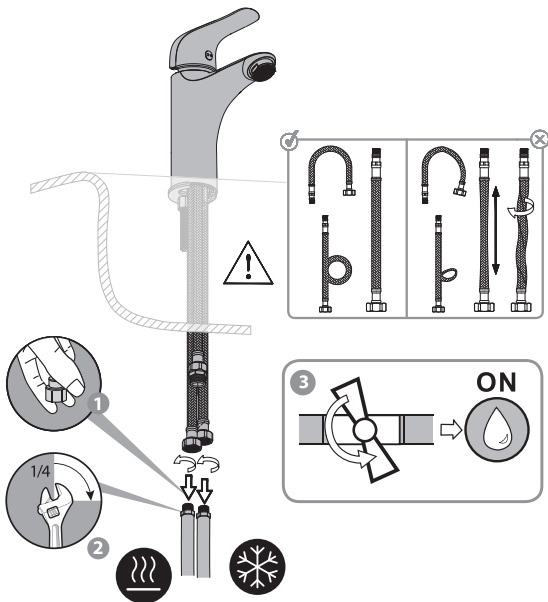





RU/ВУ:Использование горячей и холодной воды/

KZ: Суық және ыстық суды қолдану/ EN: Using hot and cold water

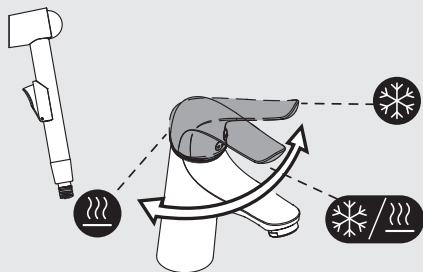
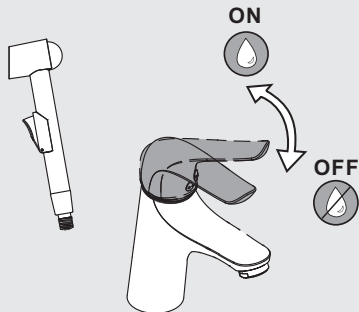

No./Номер/Нөмір	Description/Описание/Сипаттама	Code No./Номер кода/Код нөмірі	QTY/Кол-во/Мөлшері
1	Handle/Ручка/Түтқа	H6837	1
2	Cartridge/Картридж/Картридж	35D-2	1
3	Fixing part/Крепеж/Бекіту бөлігі	42212100301	1
4	Neoperl/Аэратор/Аэратор	02.1340.0.0001	1
5	Shattaf and Shower hose/лейка и Душевой шланг/Шаттаф және душқаарналған шла	F409-1	1
6	Inlet hose/Гибкий шланг/Кіріс шланг	21450300303	2
7	Hose/шланг/шланг	21150100303	1

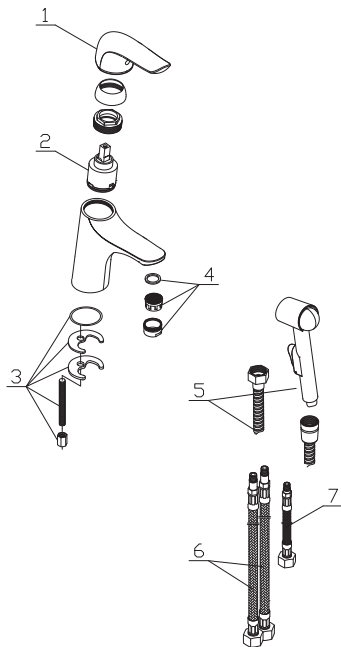

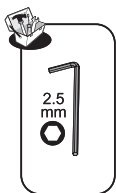

**RU/BY:** Смена картриджа/ **KZ:** Картриджді ауыстыру/  
**EN:** Replacing the cartridge

1



**ВЫКЛ**

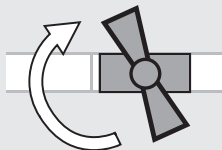

2

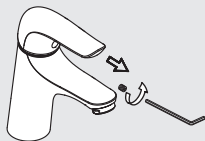

3



4



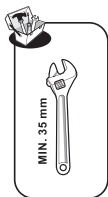

**RU/BY:** Смена картриджа/ **KZ:** Картриджді ауыстыру/  
**EN:** Replacing the cartridge

5

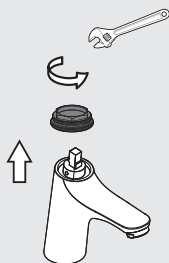

6

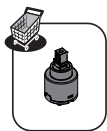
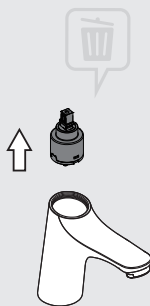

7

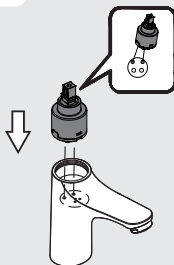

8

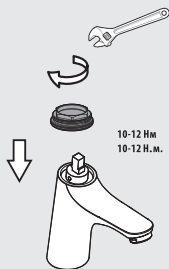



**RU/BY:** Смена картриджа/ **KZ:** Картриджді ауыстыру/  
**EN:** Replacing the cartridge

9



10

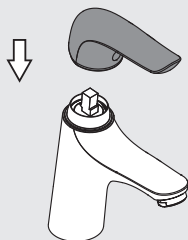

11

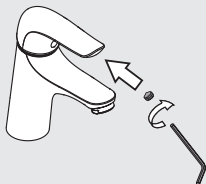

12

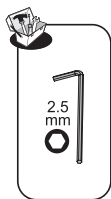

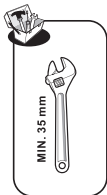

**RU/BY:** Смена аэратора/ **KZ:** Аэратор ауыстыру/ **EN:** Replacing the aerator

1

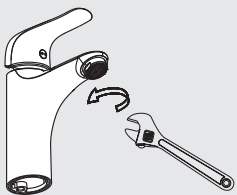

2

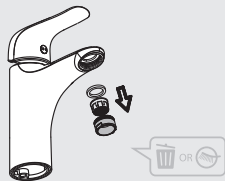

**RU**  
**BY**

Чистка

**KZ**

тазарту

**EN**

Cleaning



3

**RU**  
**BY**

Уксус

**KZ**

Сірке су

**EN**

Vinegar

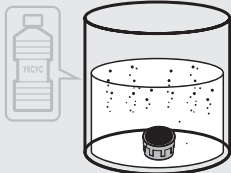

4

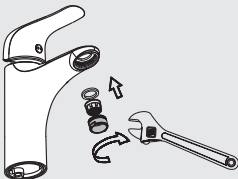

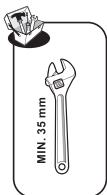

RU/ВУ: Смена гибкого шланга для смесителя/  
KZ: Қоспалауышқа арналған иілгіш шлангты ауыстыру/ EN: Replacing the hoses

1



**ВЫКЛ**

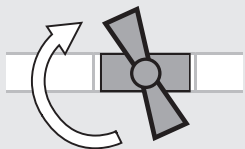

2

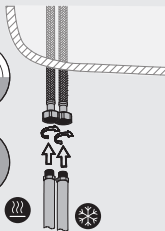

3

**ВКЛ**

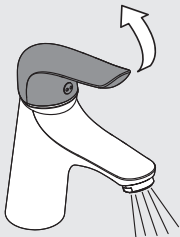

4

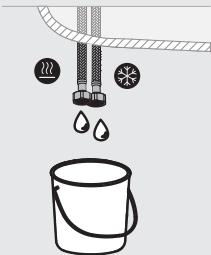

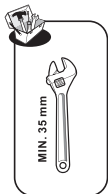

**RU/BY:** Смена гибкого шланга для смесителя/  
**KZ:** Қоспалауышқа арналған иілгіш шлангты ауыстыру/ **EN:** Replacing the hoses

5

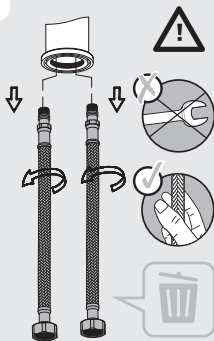

6

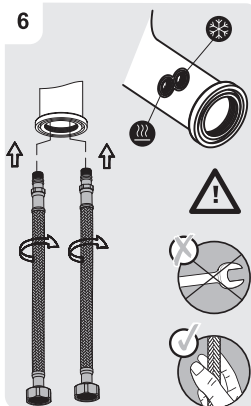

7

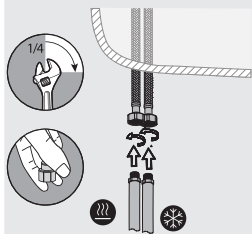

8







Чистая вода / Таза су / Clean water



Без растворителя / Еріткішсіз / Solvent-free

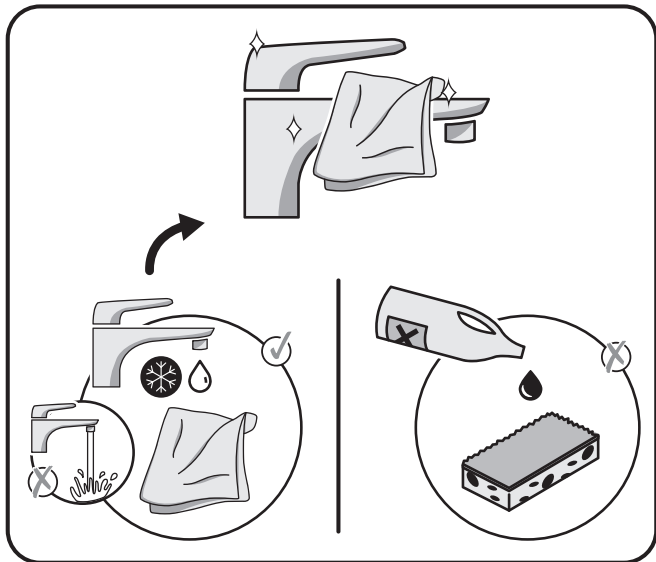







Декларация о соответствии санитарным нормам  
Санитарлық талаптарға сәйкестік декларациясы  
Declaration of sanitary conformity.

• Кепілдік 5 жыл / Гарантия 5 лет / 5 -year guarantee

Made in P.R.C. 2019

**FR** ADEO Services - 135 Rue Sadi Carnot - CS 00001  
59790 RONCHIN - France

**UA** ТОВ «Леруа Мерлен Україна»,  
вул. Полярна 17а, м. Київ 04201, Україна

**RU** ООО ЛЕРУА МЕРЛЕН ВОСТОК, 141031, Московская  
область, г. Мытищи, Осташковское шоссе, д.1, РОССИЯ

**BY** Поставщик/импортер/организация, принимающая  
претензии по качеству товара в Республике  
Беларусь: ООО «Леруа Мерлен Бел», 220020,  
Республика Беларусь, г. Минск, пр-т Победителей,  
д. 100, каб. 503

**KZ** Қазақстан Республикасында өнім сапасы бойынша  
наразылықтарды қарындауға уәкілетті ұйым: «Леруа Мерлен  
Қазақстан» ЖШС, Қазақстан Республикасы, 050000,  
Алматы қ., Қонаев көшесі, 77, «PARKVIEW» БО, 6-қабат, 07-кеңсе.  
Организация, уполномоченная принимать претензии по  
качеству продукции в Республике Казахстан: ТОО «Леруа  
Мерлен Казахстан», Республика Казахстан, 050000, г. Алматы,  
ул. Кунаева, 77, БЦ «ParkView», 6 этаж, офис № 07.

