

#### Features

- Low-threshold design for easy entry and exit.
- Recessed left drain.
- Single threshold for three-wall installation.
- Requires K-9330 Groove aluminum drain cover or K-9334 Groove teak drain cover (sold separately).

#### Material

- Acrylic.

#### Required Products/Accessories

K-9330 Drain Cover

or

K-9334 Drain Cover

#### Recommended Products/Accessories

K-9132 Shower Drain

K-23726 Drain treatment

K-23732 Tub & shower cleaner



#### Codes/Standards

CSA B45.5/IAPMO Z124

ASTM E162







ASTM E662

#### KOHLER® Plastic Baths and Receptors Lifetime Limited Warranty

See website for detailed warranty information.

#### Available Colors/Finishes

*Color tiles intended for reference only.*

Color	Code	Description
	0	White
	96	Biscuit
	47	Almond
	NY	Dune
	95	Ice™ Grey
	G9	Sandbar

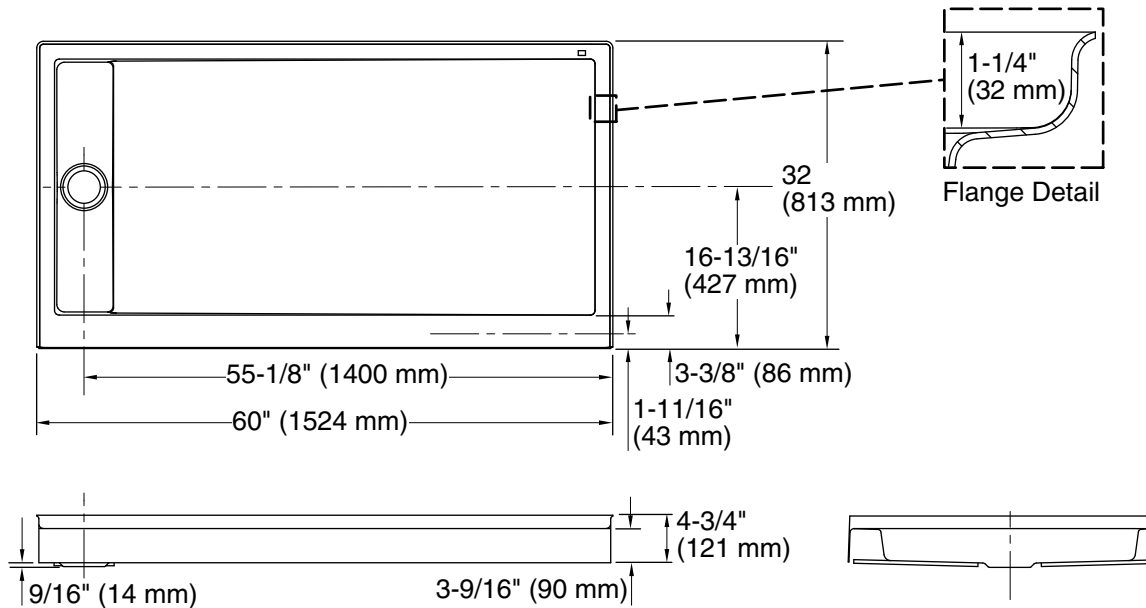

### Technical Information

All product dimensions are nominal.

Installation:	Three-wall alcove
Drain location:	Left
Weight:	65 lbs (29.5 kg)
Minimum floor load:	20 lbs/ft <sup>2</sup> (97.6 kg/m <sup>2</sup> )

### Notes

- Measure your actual product for rough-in details. Install this product according to the installation instructions.
- Measure your actual product for roughing-in details.
- Shimming may be required to level the fixture.
- Shimming may be required between the stud frame and the fixture.
- The stud opening tolerance is +1/4" (6 mm), -0" (0 mm).