

# 5397200

## Finezza Due Series

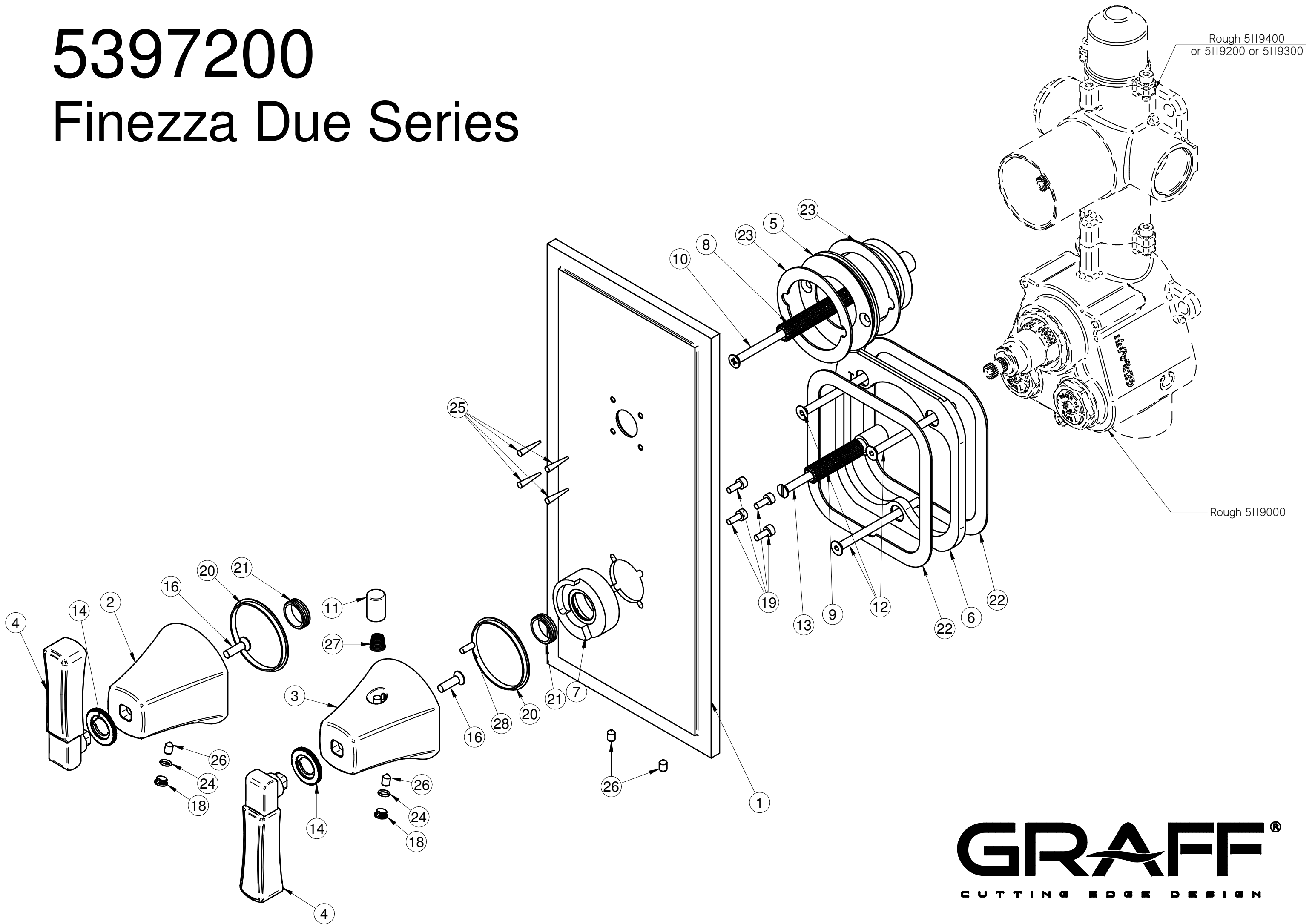

**GRAFF**<sup>®</sup>  
CUTTING EDGE DESIGN