

Drawer element
40521.2

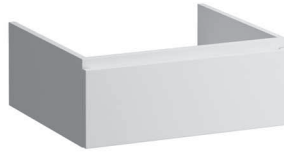

TECHNICAL DATA

Order no.	40521.2 / 1 drawer
Dimensions (WxHxD)	595 x 230 x 520 mm
Specification	Body/Front – MDF board with PVC foil Integrated handle on the top of the drawer Without top for mounting under washtop
Special specification	In combination with washtop
Weight	17,5 kg
Accessories excl.	Towel rail, anodized aluminium, order no. 49095.2 Space saving siphon, order no. 89424.0
Mounting acc. incl.	Installation set, order no. 49137.8

Mounting information	The walls installed on must meet the requirements of the furniture in terms of weight and the supplied fastening elements. If this cannot be guaranteed another method of installation needs to be chosen.
Colours	463 – White 519 – Chalked oak 548 – Anthracite oak

TECHNICAL DRAWINGS / S 1 : 20

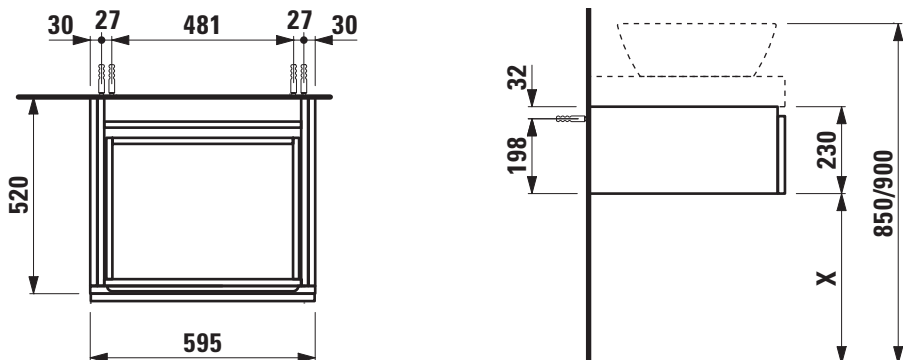

X = The exact height must be set during installation.