

5194700

FINEZZA DUE Series

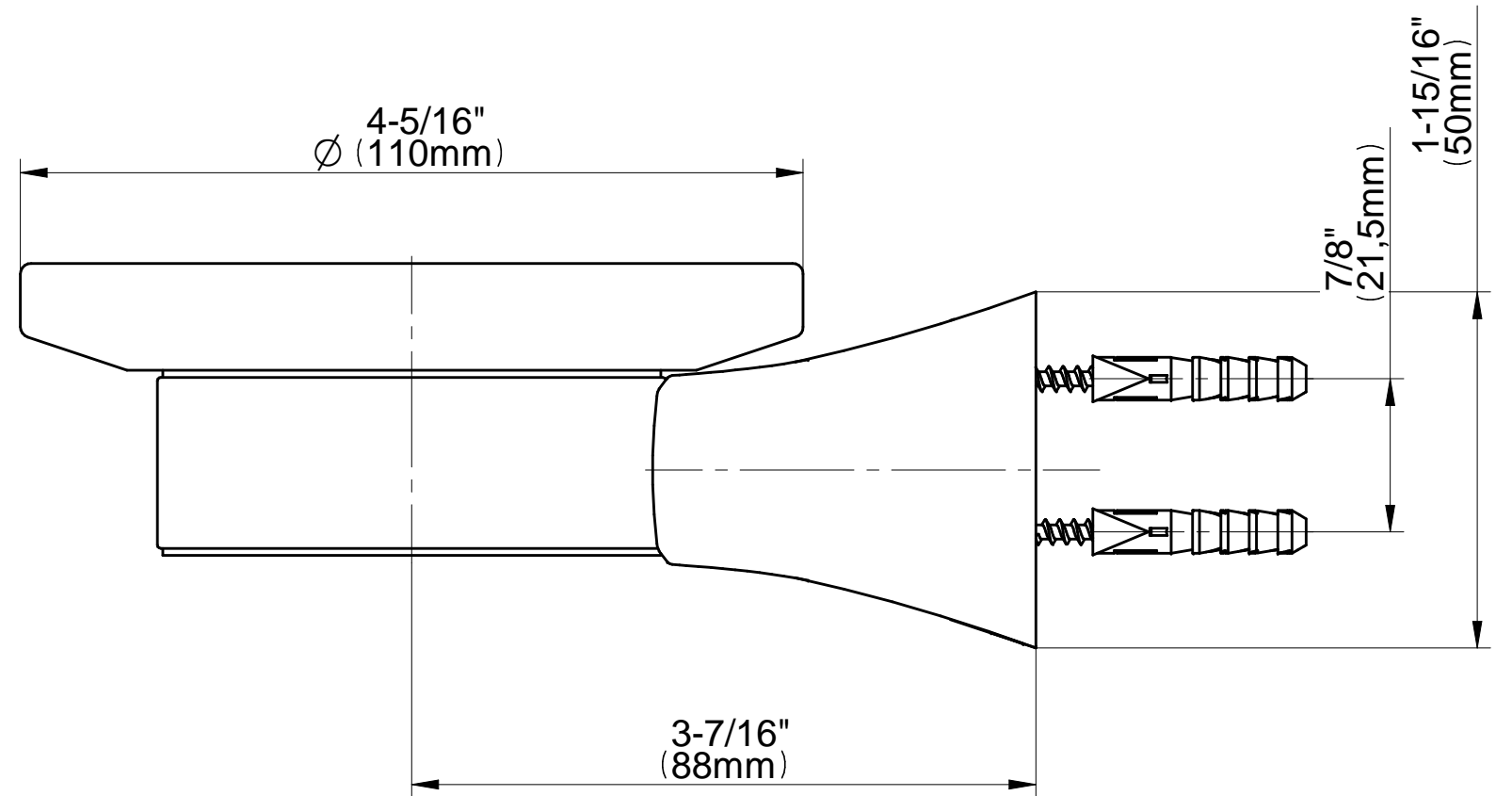
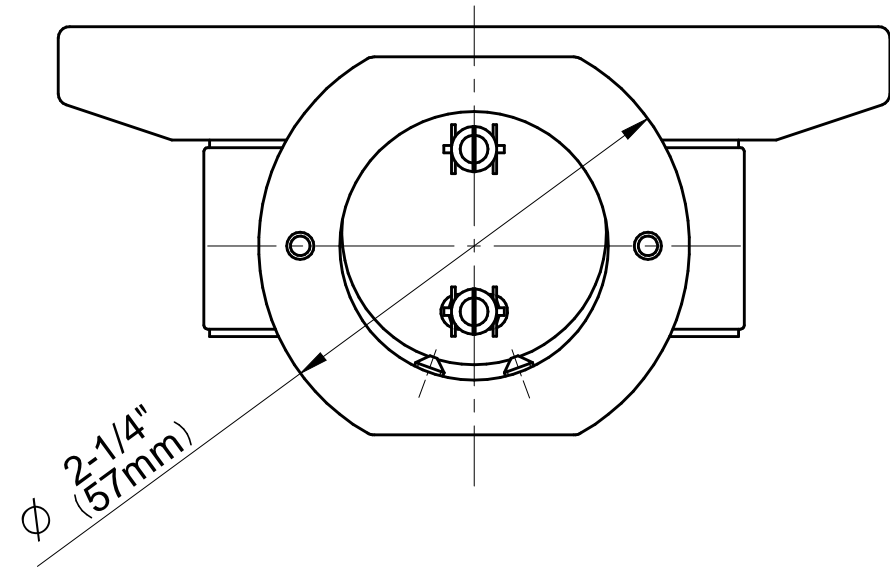

SOLID EDGE RESELLER COPY

GRAFF[®]
CUTTING EDGE DESIGN