



DANIEL

SCHEDA TECNICA TECHNICAL FEATURES

ART. COD.

A40860

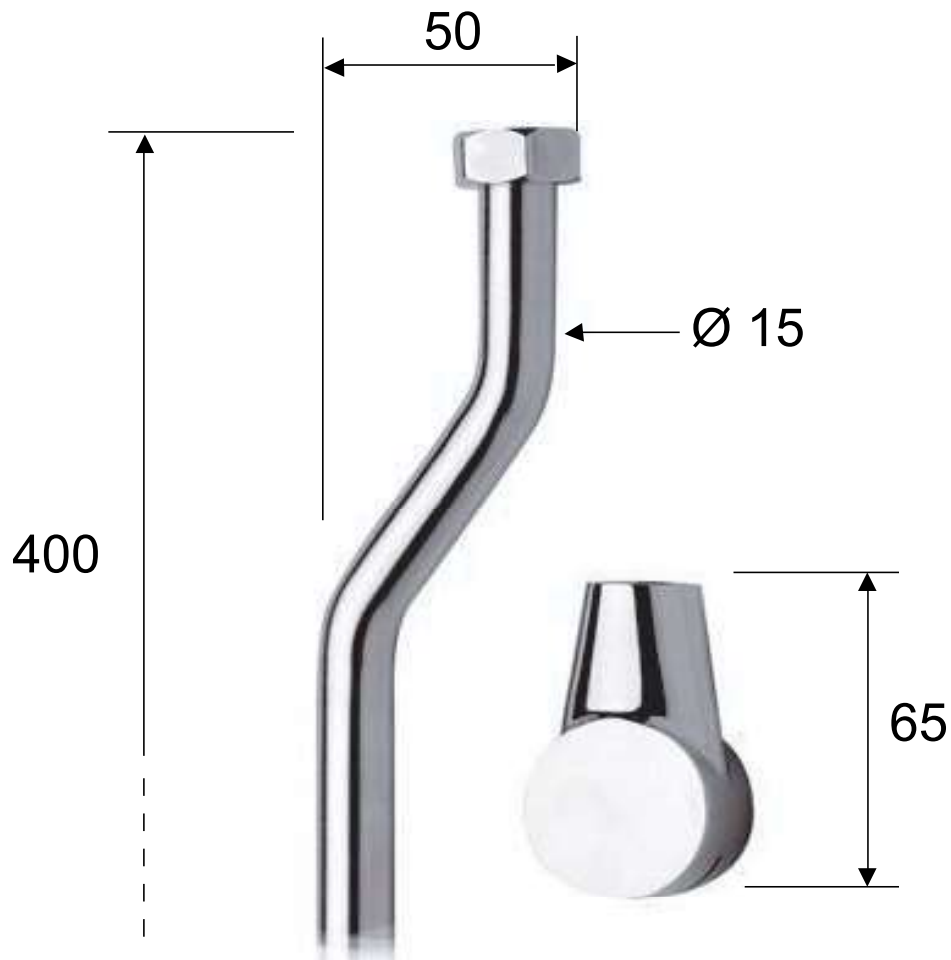

MATERIALI / MATERIALS

OTTONE CROMATO / CHROME PLATED BRASS

CROMATURA / CHROME PLATING

UNI EN 248