

Features

- Single-speed whirlpool offers performance and value, with 6 fully adjustable jets.
- Hydromassage flow and direction can be controlled at each jet.
- Built-in heater.
- Spacious design accommodates up to two bathers.
- Corner layout minimizes footprint without compromising bathing area.
- Integral faucet deck.

Material

- Acrylic.

Hydrotherapy

- Whirlpool.

Installation

- Drop-in.

Recommended Products/Accessories

- K-7213 27" Cable Bath Drain
- K-7214 27" Cable Bath Drain
- K-24916 Wireless Music Kit
- K-1491 Bath/Whirlpool Pillow
- K-1601 Bath/Whirlpool Footstop
- K-7259 Clearflo Bath Drain
- K-7265 Clearflo Bath Drain
- K-23726 Drain treatment
- K-23732 Tub & shower cleaner
- K-7161-AF 1-1/2" adjustable pop-up drain above- or through-floor
- K-37383 Rough-in cable bath drain, PVC, 30" cable with tubing
- K-37386 rough-in cable drain, PVC, 30" cable
- K-7166-AF Bath Drain
- K-37380 30" Rough-in Cable Bath Drain



Codes/Standards

ASME A112.19.7/CSA B45.10
CSA B45.5/IAPMO Z124
UL 1795



**KOHLER® Plastic Baths and Receptors
Lifetime Limited Warranty
KOHLER® Hydrotherapy Components
Five-Year Limited Warranty**

See website for detailed warranty information.

Available Colors/Finishes

Color tiles intended for reference only.

Color	Code	Description
-------	------	-------------

	0	White
	96	Biscuit
	47	Almond

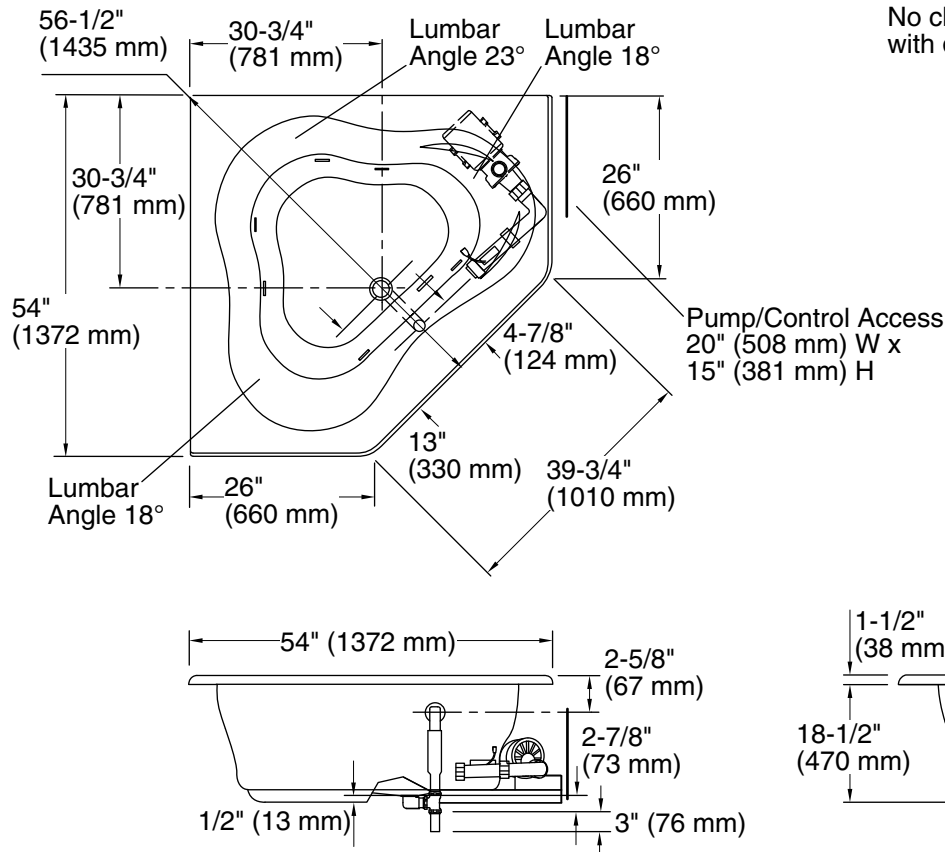

No change in measurements if connected with drain illustrated. (K-11677)

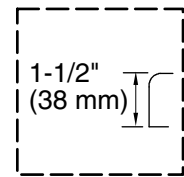

Drop-in Rim Detail

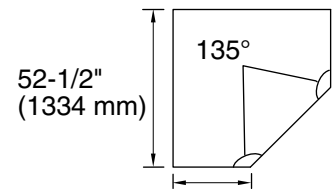

25" (635 mm)

Cut-out Detail
Drop-in Rim Style

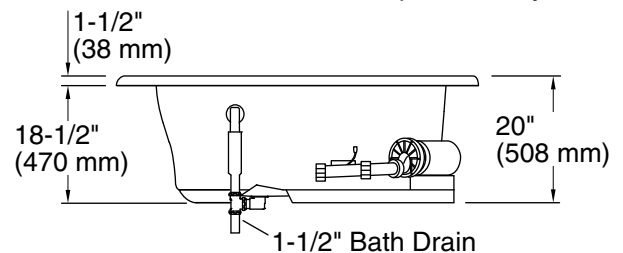

Required Electrical Service

Two dedicated circuits required, protected with Class A Ground-Fault Circuit-Interrupter (GFCI). Outside North America, this device may be known as a Residual Current Device (RCD).

Pump:	120 V, 15 A, 60 Hz
Heater:	120 V, 15 A, 60 Hz

Technical Information

All product dimensions are nominal.

Installation:	Corner, Drop-in
Drain location:	Center
Basin area, bottom:	44" x 36" (1118 mm x 914 mm)
Basin area, top:	56" x 43" (1422 mm x 1092 mm)
Weight:	70 lbs (31.8 kg)
Minimum floor load:	36 lbs/ft ² (175.8 kg/m ²)
Water depth:	15" (381 mm)
Water capacity:	76 gal (287.7 L)
Electrical component rating:	Pump: 120 V, 7.5 A, 60 Hz Heater: 120 V, 12.5 A, 60 Hz, 1500 W
Pump speed:	Single

Notes

Measure your actual product for rough-in details. Install this product according to the installation instructions.

The hot water supply should be 70% of the capacity of the bath or greater. Installations will vary.