

Sink KE Filotop Gun Metal 2155 056

Sinks

Code: 2155 056



DETAILS

Coloring Gun Metal

Finish PVD

Material AISI 304 stainless steel

Texture Foster brushed

Base 60 cm

Edge/Installation Type Flush-mount | Top-mount

Dimensions 540x440 mm

Standard fittings Fixing hooks, gasket, drain, overflow and siphon, boxed packing

Mixer holes No standard holes

Built-in hole	View technical data sheet (for all Flush-mount / Top-mount models and Under-mount models)
Drainer	No
Width	54 cm
Bowl dimension	500x400mm
Number of bowls	1 bowl
Waste fitting	3,5" drain

FEATURES

Basket 3,5" waste fitting	The drain is equipped with a large 3.5" drain, with the practical basket cap that prevents the discharge of solid parts. The 3.5 "drain allows the use of the Foster waste-disposer, compatible with all models.
Gun Metal	The Gun Metal finish is obtained by treating steel with a physical process called PVD (Physical Vacuum Deposition) which deposits particles of noble metals on the surface. The result is a unique and refined aesthetic effect, and an improvement of the mechanical properties of the steel which is more resistant to impact and scratches.
High thickness	1mm thick steel. A significant thickness, which guarantees the maximum sturdiness and durability.
Perimetral overflow	The overflow is always a security on the Foster sinks that prevents the overflow of water in case of oversights. The perimeter drain solution improves aesthetics thanks to its square and essential shape.
Small radius	Bowls with squared shapes with a modern design and an increased capacity, for a minimal aesthetics connected with an extreme practicality.

TECHNICAL DATA





Intaglio per il troppo-pieno
Recess for housing the over-flow

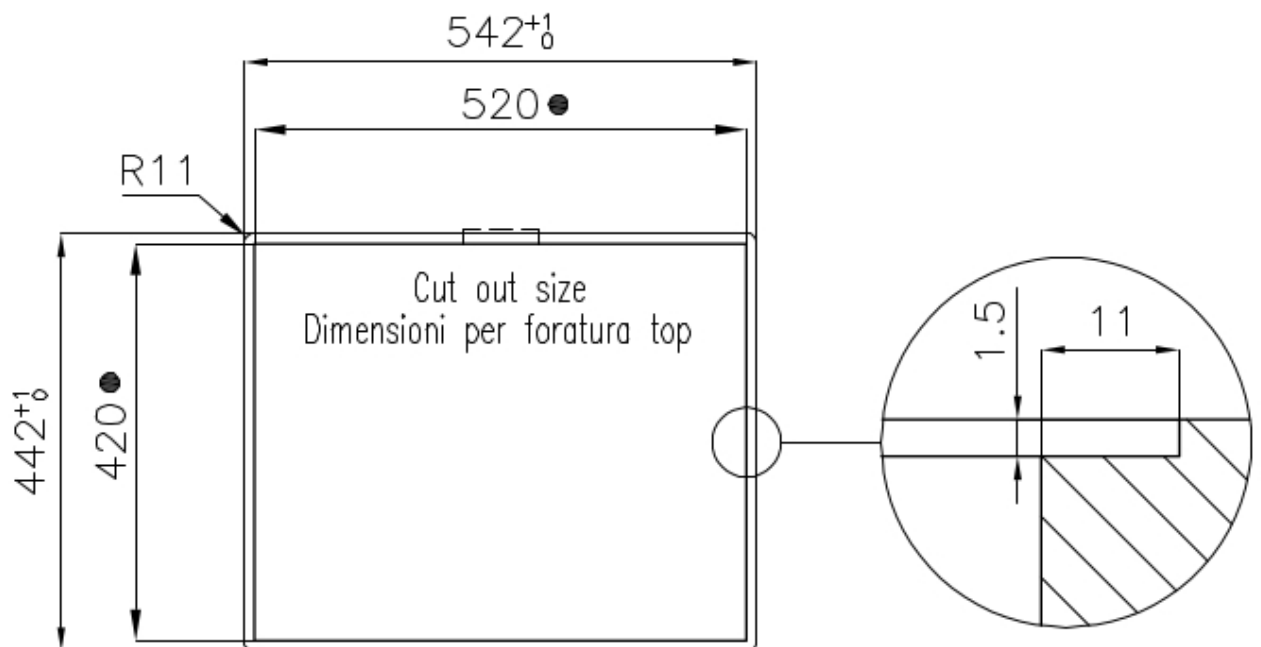

- Built-in cut out for FTS – Foratura per installazione FTS

OPTIONAL ACCESSORIES



Cestello inox 8612 000



Glass chopping board 8631 300



HPDE Chopping board 8657 001



HPDE Twin chopping board 8644 101



Iroko-wood chopping board with stainless steel colander 8644 042



Iroko-wood sliding chopping board 8644 041



Iroko-wood twin chopping board 8644 004



Stainless steel colander 8154 000



Stainless steel plate rack 8100 154

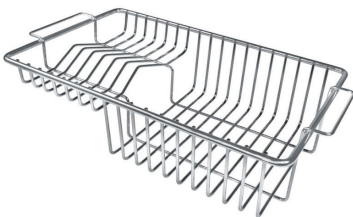

Stainless steel plate rack 8100 201

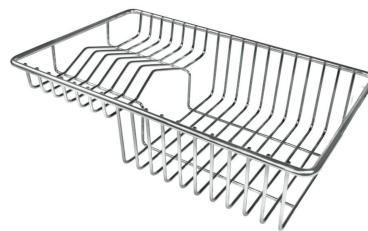

Stainless steel plate rack 8100 303



White bowl 8153 100



Graters kit with ring-holder and food collection tray 8159 101



Stainless steel perforated tray 8151 000

WARNING:

The accessories 8159101, 8100303,8151000 are only usable in combination with 8644101

The accessories 8100154, 8154000 are only usable in combination with 8644004

RECOMMENDED PAIRINGS



Mixer Tap Bert 8428 100



Mixer Tap KE 8492 000

OPTIONAL AUTOMATIC WASTE FITTINGS



Gun Metal automatic waste fitting 8407 110