

5385600

Finezza Due Series

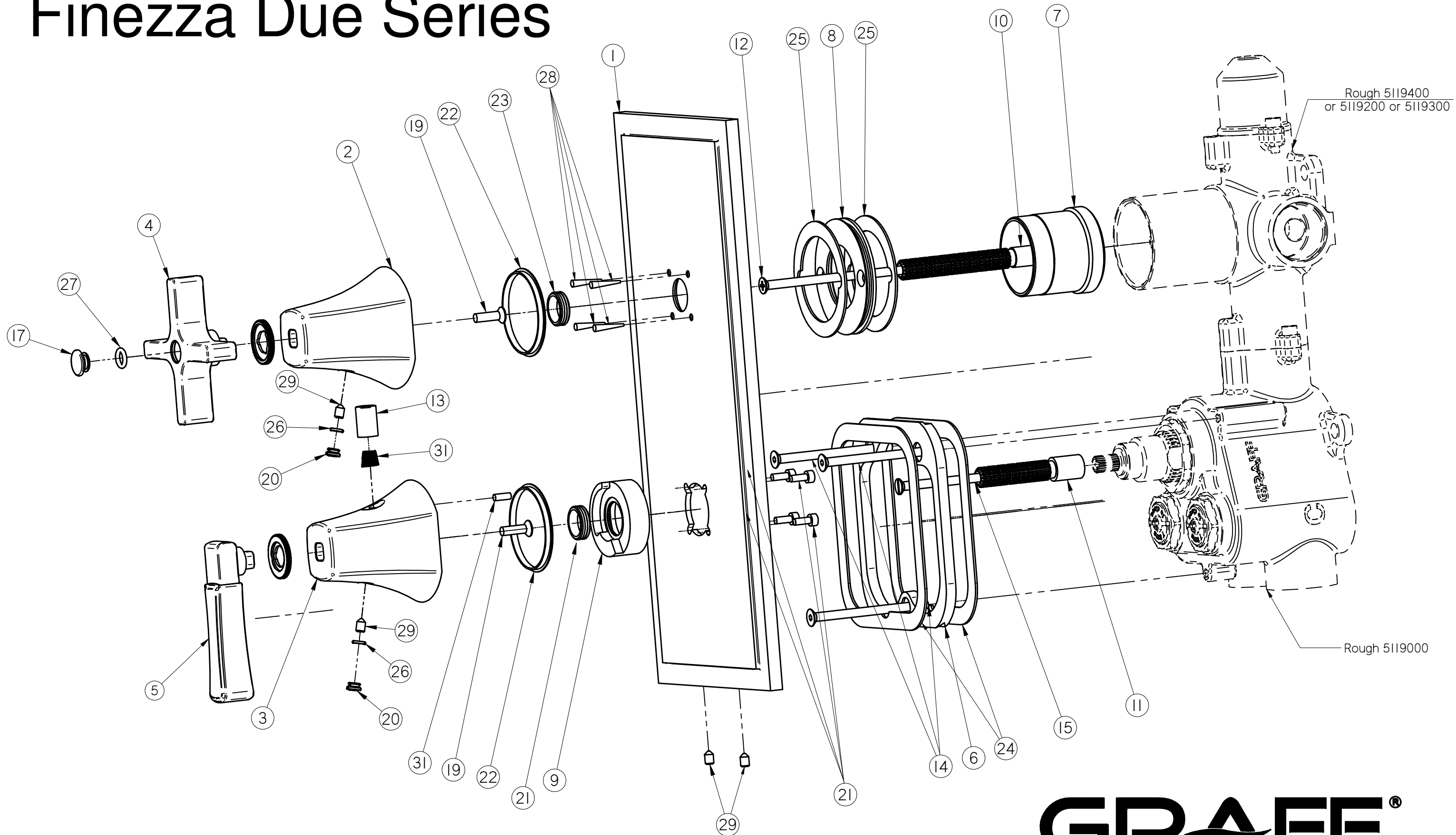

GRAFF[®]
CUTTING EDGE DESIGN