

E22C130



Collection: CONTRA

Finish*:



GA - Profils chromés

Main features:



Features

- DIMENSIONS: 195 x 130 cm
- MATERIAL: Clear glass
- NORMS AND REGULATION: EN 14428
- MIN/MAX WIDTH WITH FIXED PANEL: 51
- GLASS THICKNESS IN MM: 8
- WEIGHT: 56 kg
- INSTALLATION TYPE: Alcove or corner
- MIN/MAX WIDTH WITH SINGLE DOOR: 53
- OPENING: 53
- PANEL HEIGHT IN CM: 195

Technical drawing

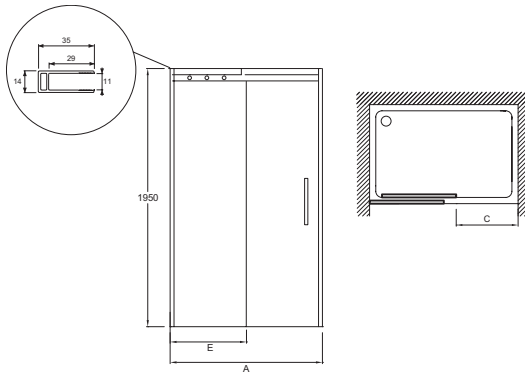

	E22C100	E22C110	E22C120	E22C130	E22C140	E22C150	E22C160	E22C170	E22C180
Mm	1000	1100	1200	1300	1400	1500	1600	1700	1800
A mini/maxi	975 / 1005	1075 / 1105	1175 / 1205	1275 / 1305	1375 / 1405	1475 / 1505	1575 / 1605	1675 / 1705	1775 / 1805
C	380	430	440	530	540	580	640	640	680
E	488	538	588	638	688	788	788	888	988

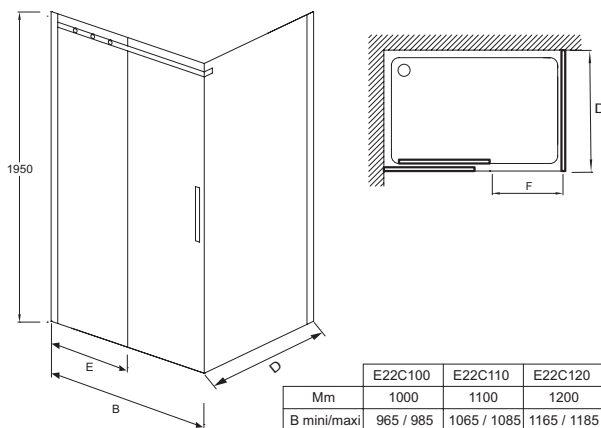

	E22C100	E22C110	E22C120	E22C130	E22C140	E22C150	E22C160	E22C170	E22C180
Mm	1000	1100	1200	1300	1400	1500	1600	1700	1800
B mini/maxi	965 / 985	1065 / 1085	1165 / 1185	1265 / 1285	1365 / 1385	1465 / 1485	1565 / 1585	1665 / 1685	1765 / 1785
F	360	410	420	510	520	560	620	620	660
E	488	538	588	638	688	788	788	888	988

Product Specification: Sliding door 130 cm. E22C130. Collection: CONTRA. DIMENSIONS: 195 x 130 cm. WEIGHT: 56 kg. MATERIAL: Clear glass. INSTALLATION TYPE: Alcove or corner. NORMS AND REGULATION: EN 14428. MIN/MAX WIDTH WITH SINGLE DOOR: 53. MIN/MAX WIDTH WITH FIXED PANEL: 51. OPENING: 53. GLASS THICKNESS IN MM: 8. PANEL HEIGHT IN CM: 195.

*Due to possible variations in computer and printer calibrations, technical factors and certain finish characteristics, the colors you see may not accurately portray the actual colors and are provided as a guide only.