

i RICAMBI / SPARE PARTS

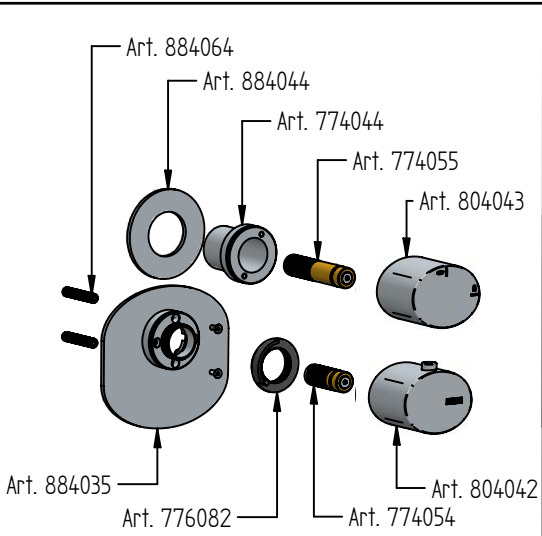

Cod. 884035

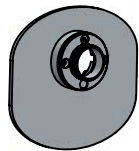

Cod. 884044



Cod. 886064



Cod. 774054



Cod. 774044



Cod. 776082



Cod. 774055



Cod. 804042



Cod. 804043

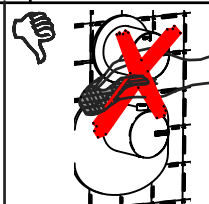
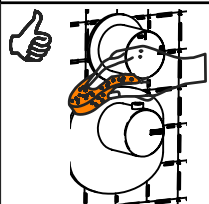
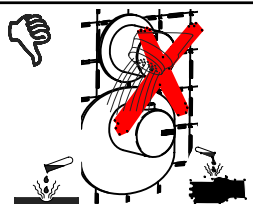
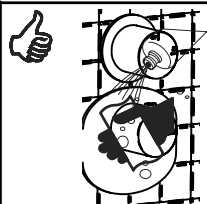

MANUTENZIONE E PULIZIA

Per una corretta manutenzione e pulizia di questo prodotto, raccomandiamo alcuni semplici accorgimenti:

- Utilizzare detersivi neutri, spruzzando il prodotto direttamente su un panno morbido onde evitare infiltrazioni
- Evitare sempre il contatto con prodotti acidi o abrasivi
- Risciacquare bene con abbondante acqua per eliminare eventuali residui ed asciugare sempre con un panno morbido
- Effettuare una pulizia periodica al fine di prevenire le formazioni calcaree

La BELLOSTA CARLO & C. non è RESPONSABILE di danni derivati dall'utilizzo di prodotti impropri per la pulizia.

MAINTENANCE AND CLEANING

For a proper maintenance and cleaning, we recommend the following:

- Use **neutral detergents**, avoiding to spray directly on taps to avoid residual infiltration
- **Avoid** contact with acid or abrasive products
- **Rinse** with water and **always dry** with a clean cloth to avoid residue of detergent
- Perform a **periodic cleaning** to prevent limestone deposits

BELLOSTA CARLO & C. cannot be held responsible for damages due to an improper use of detergents



ISTRUZIONI revivre

Art. 8012/H

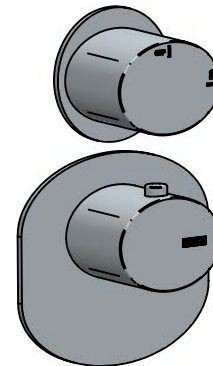

Art. 8012/2H

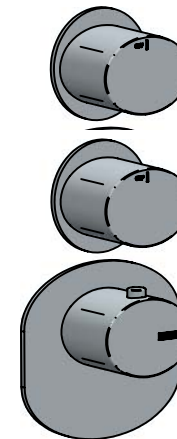

Art. 8012/3H

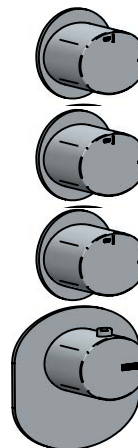

Art. 8012/4H

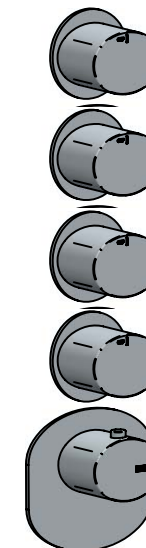

MADE IN ITALY

Questo prodotto è stato realizzato interamente in Italia con l'utilizzo di materie prime di altissima qualità

DESIGN
EOB

MADE IN ITALY

This product has been entirely manufactured in Italy, by top quality raw materials.



Rubinetti d'autore dedicati a te

1

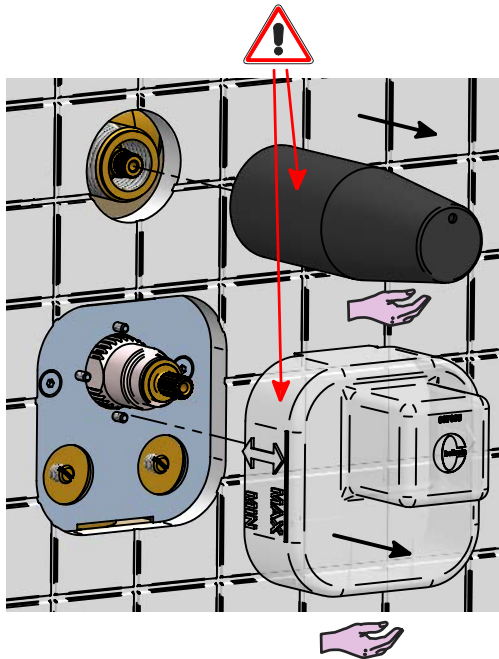

2

RIMUOVERE PELLICOLA DALLA
GUARNIZIONE BIADESIVA
TAKE OFF FROM THE GASKET
THE BY-ADHESIVE FILM



A

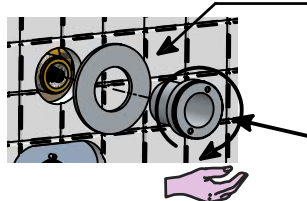

B

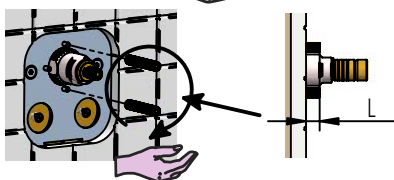

N° INTAGLI DA TAGLIARE AL
DISTENZAILE
NUMBERS OF NOTCH TO BE
CUT FROM SLEEVE

$$N_1 = L - 9$$

5

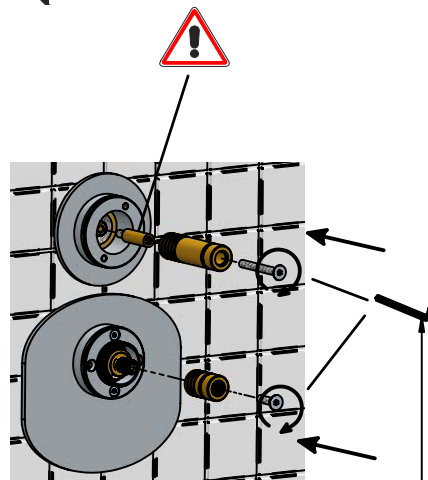

CHIAVE A
BRUGOLA
HEXAGONAL
KEY

2,5mm

6

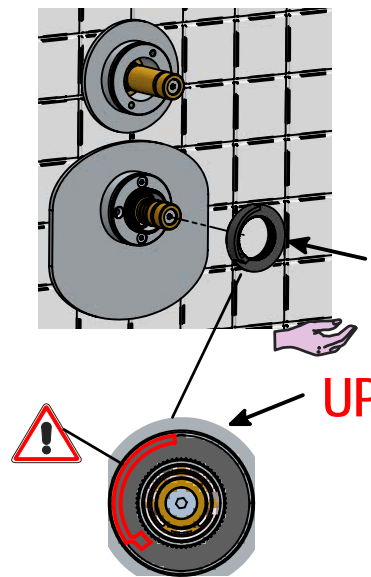

UP

3

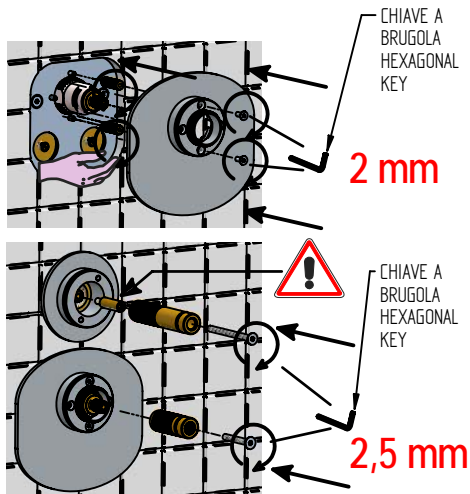

CHIAVE A
BRUGOLA
HEXAGONAL
KEY

2 mm

CHIAVE A
BRUGOLA
HEXAGONAL
KEY

2,5 mm

N° INTAGLI DA TAGLIARE
ALLE ASTE BROCCIAATE
NUMBERS OF NOTCH TO BE
CUT FROM BROACHING ROD

$$N = (X - 27) / 3$$

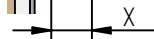

4

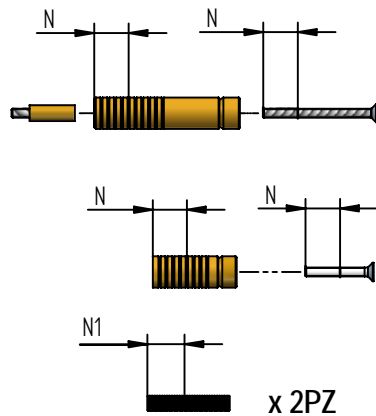

TAGLIARE ASTE BROCCIAATE
E VITI
CUT BROACHING RODS AND
SCREWS



7

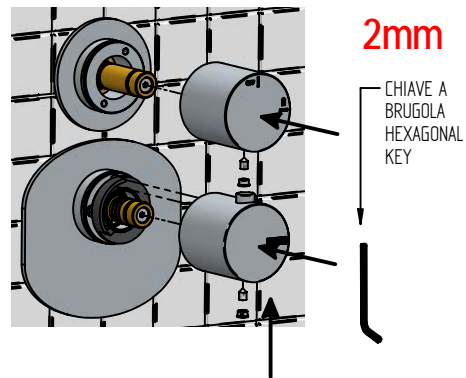

2mm

CHIAVE A
BRUGOLA
HEXAGONAL
KEY

8

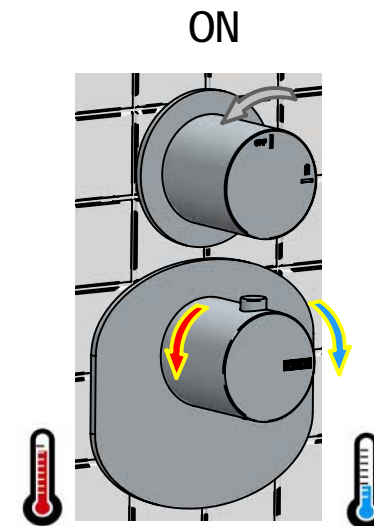

ON

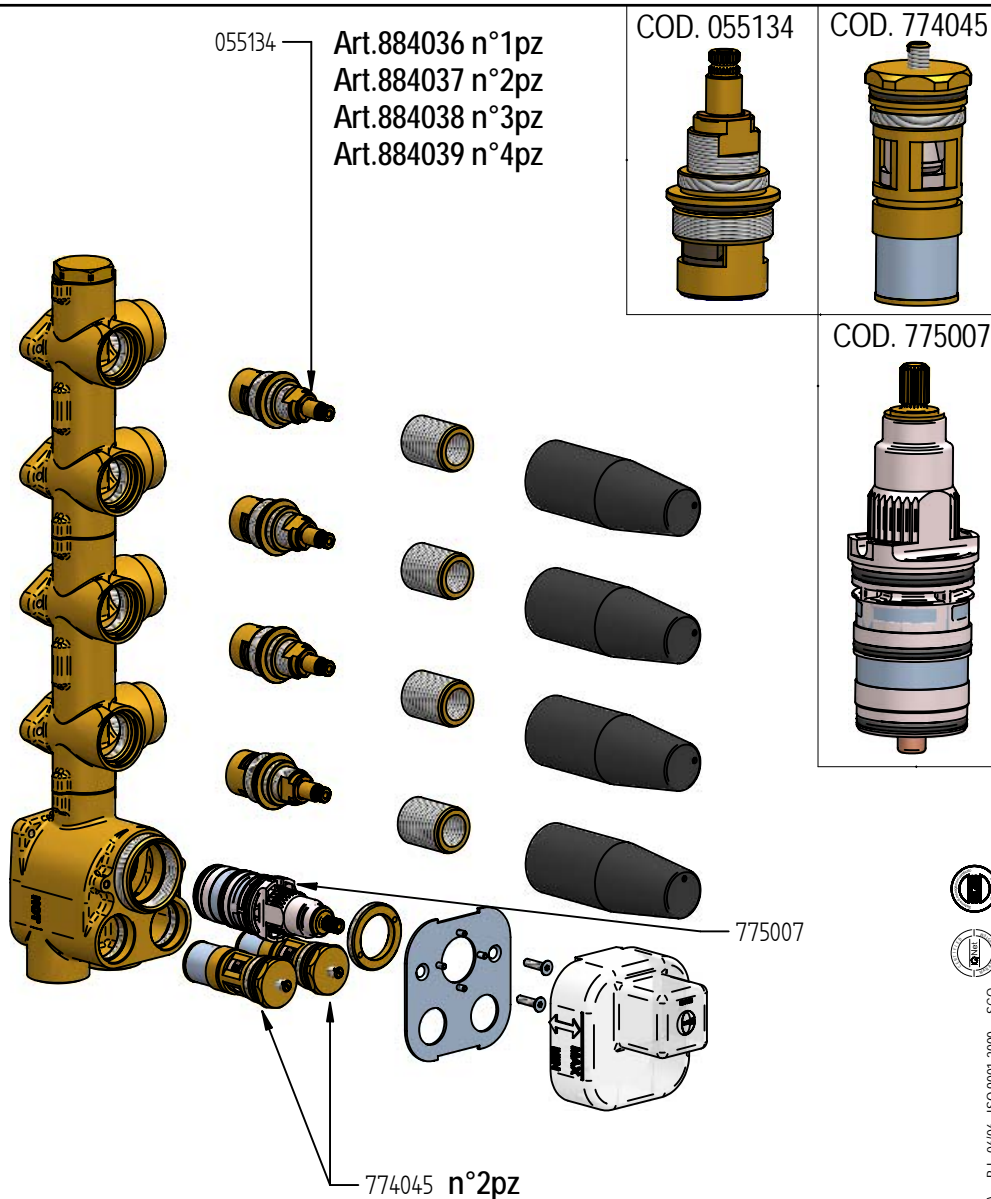

Art. 884036

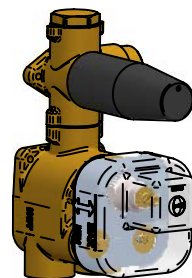

Art. 884037

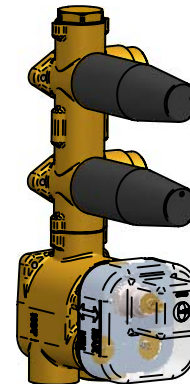

Art. 884038

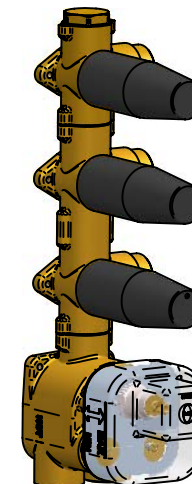

Art. 884039

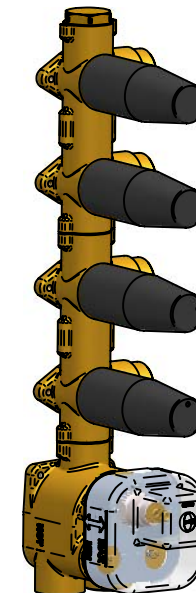

Art. 884040

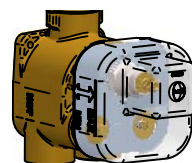

1



SPURGARE IMPIANTO



2



SCOSTAMENTO CONSIDERATO
A MURO FINITO COMPRESO
DI RIVESTIMENTO

LIMIT MEASURE AT ENDED
WALL INCLUSIVE OF COVERING

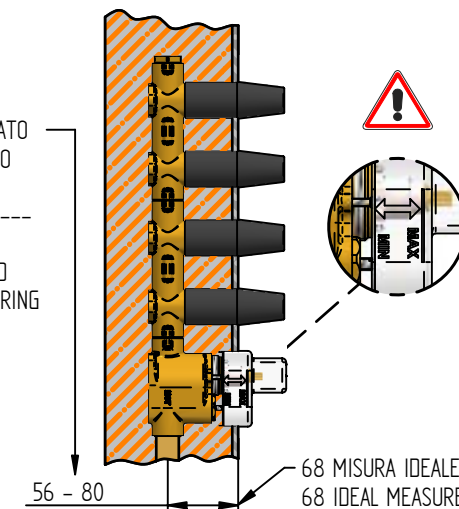

La BELLOSTA CARLO & C. non è RESPONSABILE di danni derivati dall'utilizzo di prodotti impropri per la pulizia. BELLOSTA CARLO & C. cannot be held responsible for damages due to an improper use of detergents

MADE IN ITALY

Questo prodotto è stato realizzato interamente in Italia con l'utilizzo di materie prime di altissima qualità

DESIGN

EQB

MADE IN ITALY

This product has been entirely manufactured in Italy, by top quality raw materials.



Rubinetti d'autore dedicati a te

D

MADE IN ITALY

Questo prodotto è stato realizzato interamente in Italia con l'utilizzo di materie prime di altissima qualità

DESIGN

EQB

MADE IN ITALY

This product has been entirely manufactured in Italy, by top quality raw materials.



Rubinetti d'autore dedicati a te

sufficco tecnico BELLOSTA. B.I. 06/06 ISO 9001-2000 SCQ

3 

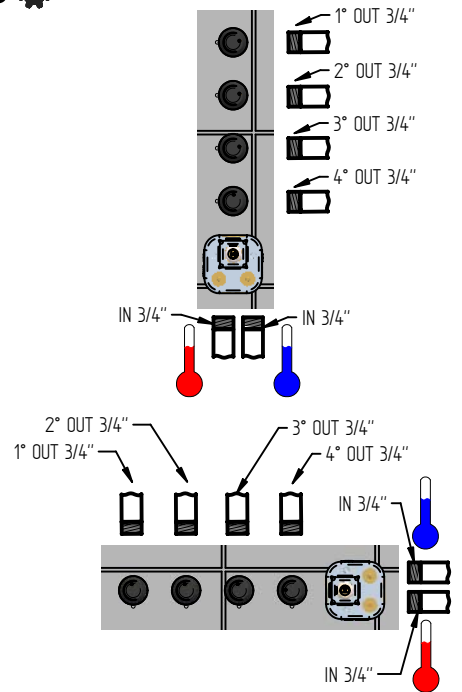

4 

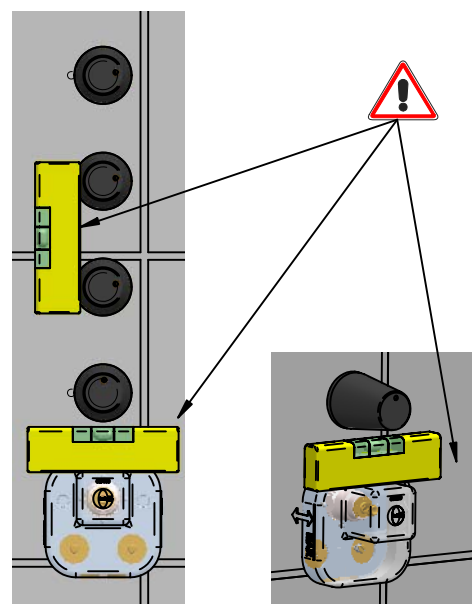

**SOSTITUZIONE VITONE ART. 055034
RIGHT CERAMIC VALVE REPLACEMENT ART. 055034**

1 

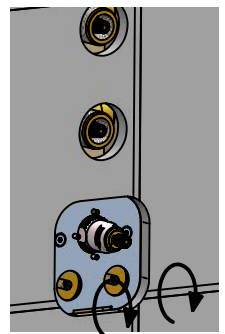

1 2

CLOSE

2 

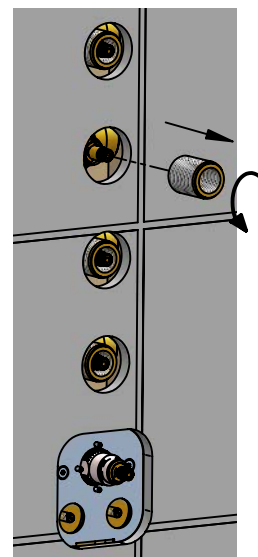

3 

CH 14 mm

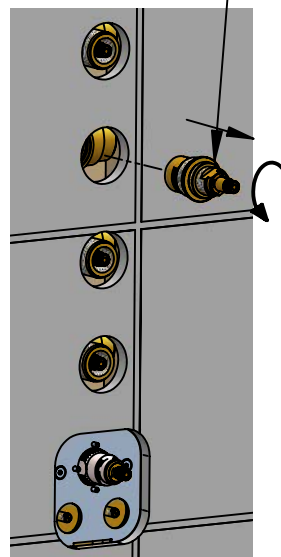

5 

 VERIFICA IMPIANTO

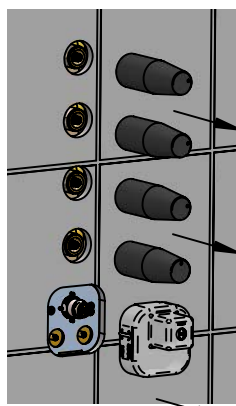

 PLANT CHECK

OPEN / CLOSE

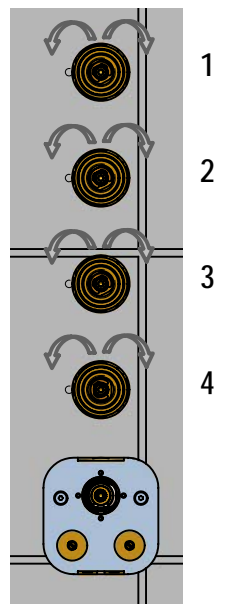

6 

 MURARE WALL UP

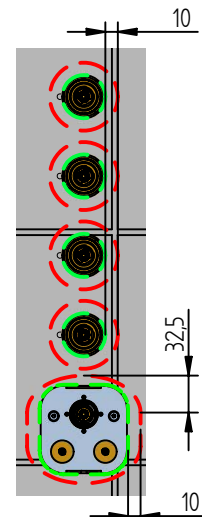
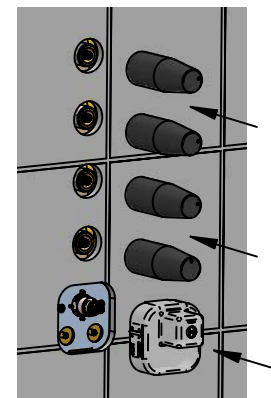

 **Dimensioni piastra e rosoni**
Wall plate and rosettes dimensions

Piastra Wall plate 100x95 ellisse 32,5
Rosoni Rosettes Ø 60

**SOSTITUZIONE CARTUCCIA ART. 775007
THERMOSTATIC VALVE REPLACEMENT ART. 775007**

1 

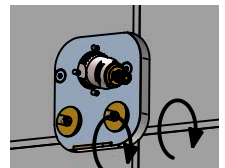

CLOSE 1 2

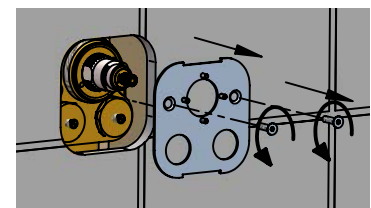

2 

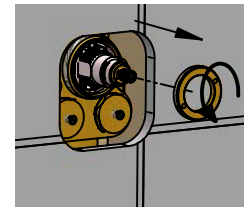
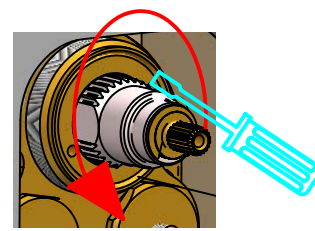

3 

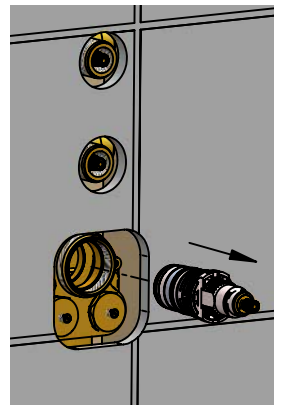

SCHEMA IMPIANTO IDRAULICO / HYDRAULIC SYSTEM LAYOUT

Art. 884038
3 OUT

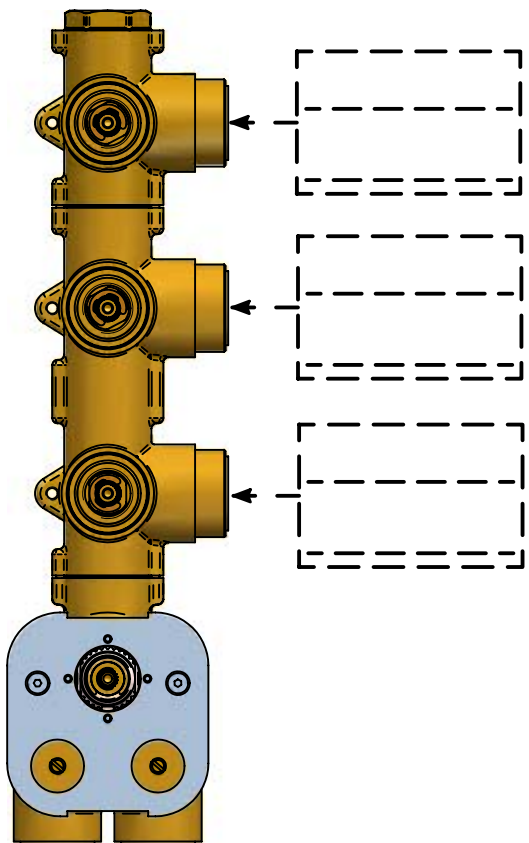

ATTENZIONE ! / WARNING !

Compilare presente schema durante il collegamento tra utenze e corpo incasso. Utilizzare sia per il collegamento delle parti esterne che per eventuali manutenzioni future. Allegare quindi alla garanzia e conservare insieme ad essa.

The layout should be filled during the installation between the built-in body and final users. Use the layout to connect the external parts and for the maintenance of the system. Join in to the maintenance manual, to keep as well.

La BELLOSTA CARLO & C. non è RESPONSABILE di danni derivati dall'utilizzo di prodotti impropri per la pulizia.

BELLOSTA CARLO & C. cannot be held responsible for damages due to an improper use of detergents

UFFICIO TECNICO BELLOSTA - B.I. 06/06 ISO 9001-2000 - SCQ

MADE IN ITALY

DESIGN
EQB

MADE IN ITALY

This product has been entirely manufactured in Italy, by top quality raw materials.



Rubinetti d'autore dedicati a te

SCHEMA IMPIANTO IDRAULICO / HYDRAULIC SYSTEM LAYOUT

Art. 884039
4 OUT

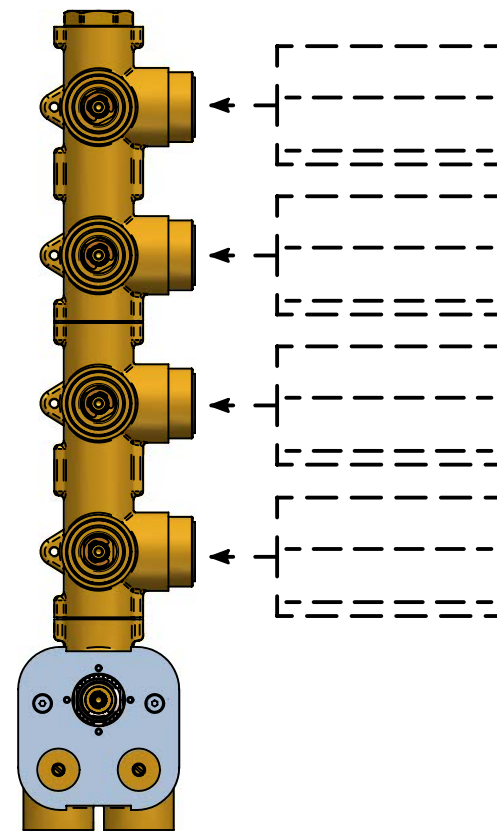

ATTENZIONE ! / WARNING !

Compilare presente schema durante il collegamento tra utenze e corpo incasso. Utilizzare sia per il collegamento delle parti esterne che per eventuali manutenzioni future. Allegare quindi alla garanzia e conservare insieme ad essa.

The layout should be filled during the installation between the built-in body and final users. Use the layout to connect the external parts and for the maintenance of the system. Join in to the maintenance manual, to keep as well.

La BELLOSTA CARLO & C. non è RESPONSABILE di danni derivati dall'utilizzo di prodotti impropri per la pulizia.

BELLOSTA CARLO & C. cannot be held responsible for damages due to an improper use of detergents

UFFICIO TECNICO BELLOSTA - B.I. 06/06 ISO 9001-2000 - SCQ

MADE IN ITALY

DESIGN
EQB

MADE IN ITALY

This product has been entirely manufactured in Italy, by top quality raw materials.



Rubinetti d'autore dedicati a te

SCHEMA IMPIANTO IDRAULICO / HYDRAULIC SYSTEM LAYOUT

Art. 884037
2 OUT

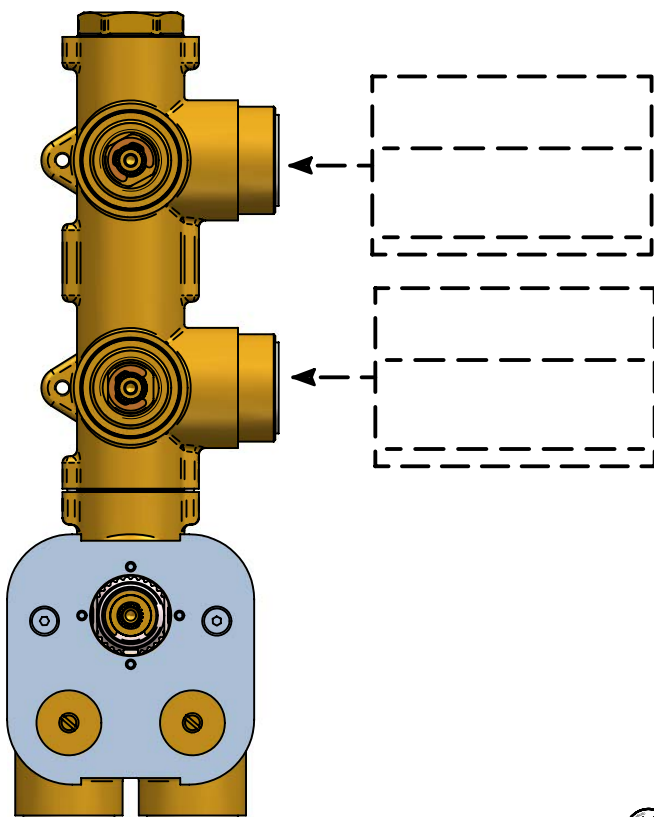

ATTENZIONE ! / WARNING !

Compilare presente schema durante il collegamento tra utenze e corpo incasso. Utilizzare sia per il collegamento delle parti esterne che per eventuali manutenzioni future. Allegare quindi alla garanzia e conservare insieme ad essa.

The layout should be filled during the installation between the built-in body and final users. Use the layout to connect the external parts and for the maintenance of the system. Join in to the maintenance manual, to keep as well.

La BELLOSTA CARLO & C. non è RESPONSABILE di danni derivati dall'utilizzo di prodotti impropri per la pulizia.

BELLOSTA CARLO & C. cannot be held responsible for damages due to an improper use of detergents



 > ufficio tecnico BELLOSTA. B.I. 06/06 ISO 9001-2000 SCQ

MADE IN ITALY

DESIGN
EQB

MADE IN ITALY

This product has been entirely manufactured in Italy, by top quality raw materials.



SCHEMA IMPIANTO IDRAULICO / HYDRAULIC SYSTEM LAYOUT

Art. 774034
4 OUT

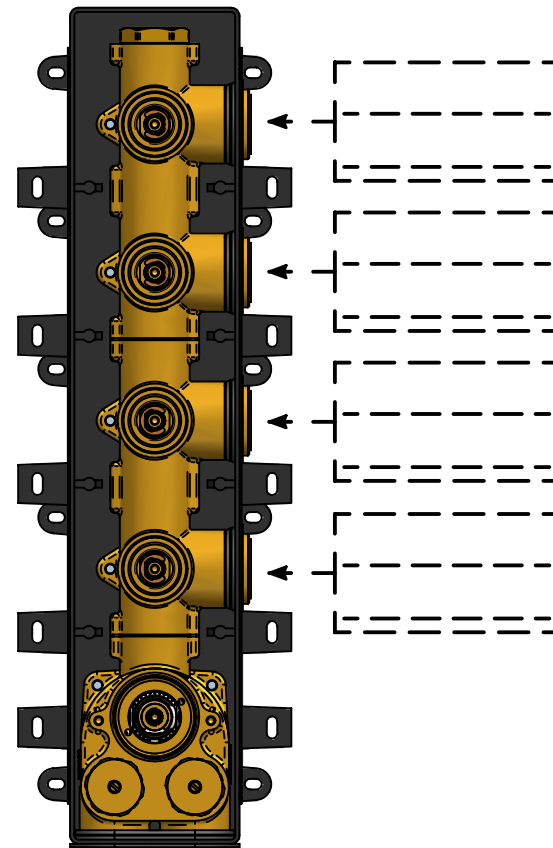

ATTENZIONE ! / WARNING !

Compilare presente schema durante il collegamento tra utenze e corpo incasso. Utilizzare sia per il collegamento delle parti esterne che per eventuali manutenzioni future. Allegare quindi alla garanzia e conservare insieme ad essa.

The layout should be filled during the installation between the built-in body and final users. Use the layout to connect the external parts and for the maintenance of the system. Join in to the maintenance manual, to keep as well.

La BELLOSTA CARLO & C. non è RESPONSABILE di danni derivati dall'utilizzo di prodotti impropri per la pulizia.

BELLOSTA CARLO & C. cannot be held responsible for damages due to an improper use of detergents



 > ufficio tecnico BELLOSTA. B.I. 06/06 ISO 9001-2000 SCQ

MADE IN ITALY

DESIGN
EQB

MADE IN ITALY

This product has been entirely manufactured in Italy, by top quality raw materials.



PULIZIA CARTUCCIA / THERMOSTATIC VALVE CLEANING

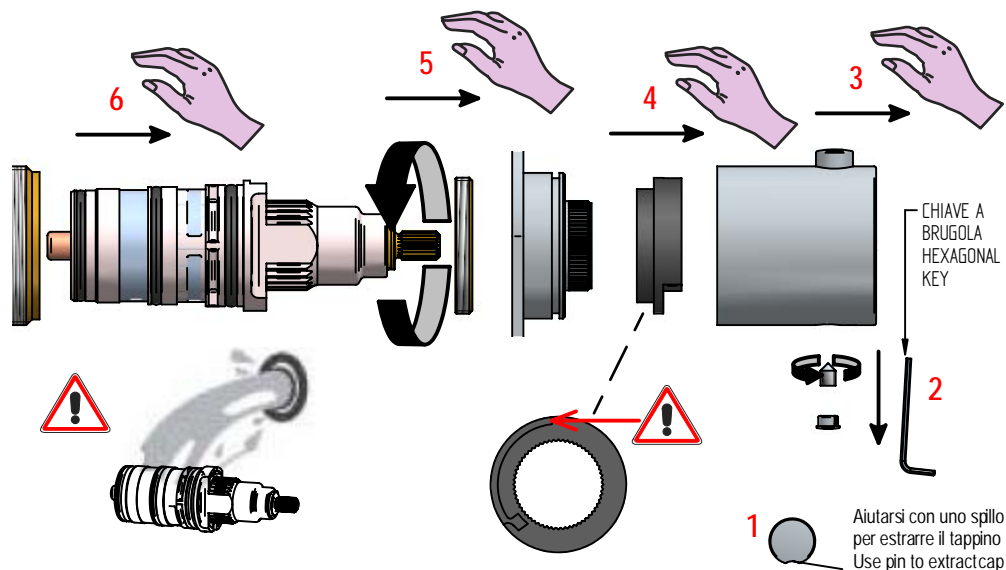

PULIZIA CARTUCCIA / THERMOSTATIC VALVE CLEANING

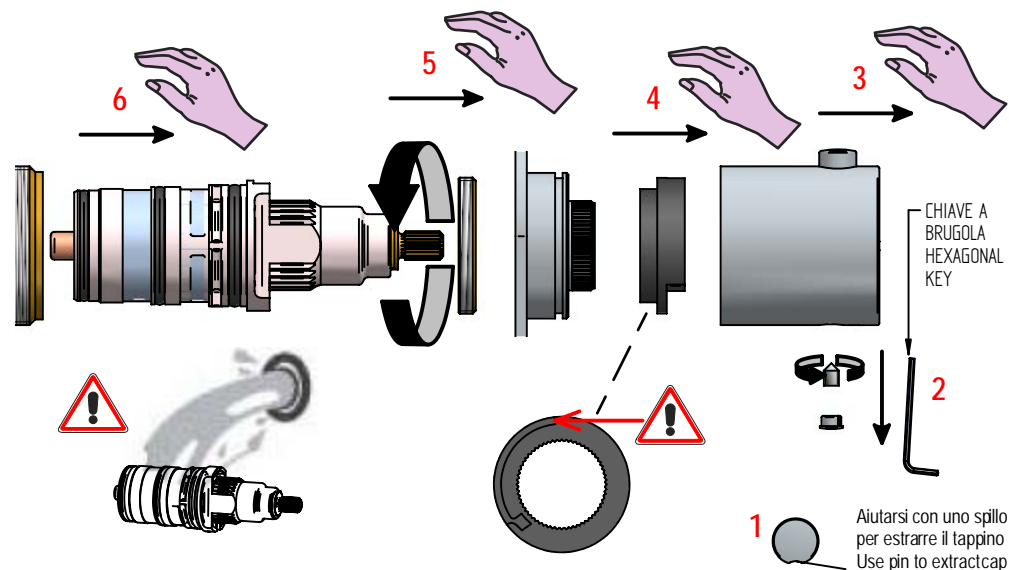

DATI TECNICI / TECHNICAL DATA

- Pressione massima di esercizio :
5 bar
- Pressione minima senza resistenza :
0,5 bar
- Pressione raccomandata :
2 - 4 bar (3 bar Ottimale)
- Blocco sicurezza 38°C :
tarato in fabbrica con pressione 3 bar (calda e fredda)
- Per pressioni superiori 5 bar :
si raccomanda riduttore di pressione
- Presenza acqua molto dura :
si raccomanda uso di un filtro addolcitore
- Forti differenze di pressione :
oltre 4 bar tra calda e fredda regolare la temperatura dell'acqua ruotando l'asta cartuccia in senso antiorario (calda) e in senso orario (fredda)

- Maximum operating pressure :
5 bar
- Minimum pressure without resistance :
0,5 bar
- Recommended pressure :
2 - 4 bar (3 bar Ottimale)
- Safety block 38°C :
calibrated in the factory at a pressure of 3 bar (hot and cold)
- For pressure over 5 bar :
the pressure reducer is recommended
- For very hard water :
the lime filter is recommended
- Strong pressure differences :
over 4 bar between hot and cold water the temperature of the mixer water can be adjusted by turning the broached pin, anti-clockwise (hot) and clockwise (cold)

DATI TECNICI / TECHNICAL DATA

- Pressione massima di esercizio :
5 bar
- Pressione minima senza resistenza :
0,5 bar
- Pressione raccomandata :
2 - 4 bar (3 bar Ottimale)
- Blocco sicurezza 38°C :
tarato in fabbrica con pressione 3 bar (calda e fredda)
- Per pressioni superiori 5 bar :
si raccomanda riduttore di pressione
- Presenza acqua molto dura :
si raccomanda uso di un filtro addolcitore
- Forti differenze di pressione :
oltre 4 bar tra calda e fredda regolare la temperatura dell'acqua ruotando l'asta cartuccia in senso antiorario (calda) e in senso orario (fredda)

- Maximum operating pressure :
5 bar
- Minimum pressure without resistance :
0,5 bar
- Recommended pressure :
2 - 4 bar (3 bar Ottimale)
- Safety block 38°C :
calibrated in the factory at a pressure of 3 bar (hot and cold)
- For pressure over 5 bar :
the pressure reducer is recommended
- For very hard water :
the lime filter is recommended
- Strong pressure differences :
over 4 bar between hot and cold water the temperature of the mixer water can be adjusted by turning the broached pin, anti-clockwise (hot) and clockwise (cold)

AVVERTENZE
WARNINGS

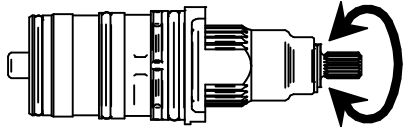

NON FORZARE NELLA ROTAZIONE

DO NOT OVERLOAD DURING ROTATION

AVVERTENZE
WARNINGS

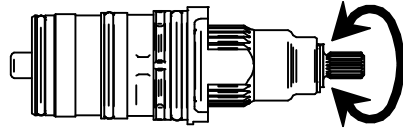

NON FORZARE NELLA ROTAZIONE

DO NOT OVERLOAD DURING ROTATION

AVVERTENZE
WARNINGS

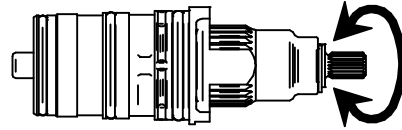

NON FORZARE NELLA ROTAZIONE

DO NOT OVERLOAD DURING ROTATION

AVVERTENZE
WARNINGS

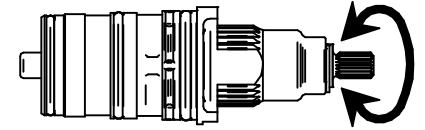

NON FORZARE NELLA ROTAZIONE

DO NOT OVERLOAD DURING ROTATION

AVVERTENZE
WARNINGS

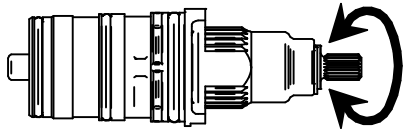

NON FORZARE NELLA ROTAZIONE

DO NOT OVERLOAD DURING ROTATION

AVVERTENZE
WARNINGS

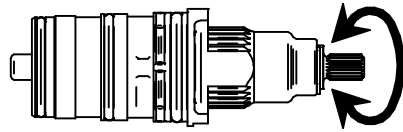

NON FORZARE NELLA ROTAZIONE

DO NOT OVERLOAD DURING ROTATION

AVVERTENZE
WARNINGS

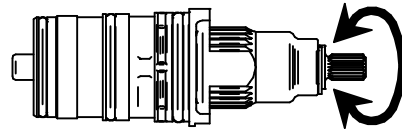

NON FORZARE NELLA ROTAZIONE

DO NOT OVERLOAD DURING ROTATION

AVVERTENZE
WARNINGS

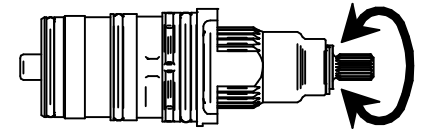

NON FORZARE NELLA ROTAZIONE

DO NOT OVERLOAD DURING ROTATION