

Sink Skin Gun Metal - 4456 046

Sinks

Code: 4456 046



DETAILS

Coloring Gun Metal

Finish PVD

Material AISI 304 stainless steel

Texture Foster brushed

Base 45 cm

Edge/Installation Type Flush-mount | Top-mount

Dimensions 440x440 mm

Standard fittings Fixing hooks, gasket, drain, overflow and siphon, boxed packing

Mixer holes No standard holes

Built-in hole	View technical data sheet (for all Flush-mount / Top-mount models and Under-mount models)
Drainer	No
Width	44 cm
Bowl dimension	400x400mm
Number of bowls	1 bowl
Waste fitting	Drain SPACE 3,5"
Notes:	As the product consists of a single seamless steel surface with no gaps or interstices, the use of garbage disposal and waste fitting with automatic control is not permitted.

FEATURES

Gun Metal	The Gun Metal finish is obtained by treating steel with a physical process called PVD (Physical Vacuum Deposition) which deposits particles of noble metals on the surface. The result is a unique and refined aesthetic effect, and an improvement of the mechanical properties of the steel which is more resistant to impact and scratches.
ONE SEAMLESS STEEL SURFACE	The waste-fitting and overflow are moulded on the sink. The product is therefore made out of one seamless steel surface, without gaps or interstices. A great plus in terms of hygiene.
Deep bowls	This bowls reach an important depth, over 20 cm, thanks to the advanced production technology, that can be offer great capieny and practicity in all the washing operations.
High thickness	1mm thick steel. A significant thickness, which guarantees the maximum sturdiness and durability.
Perimetral overflow	The overflow is always a security on the Foster sinks that prevents the overflow of water in case of oversights. The perimeter drain solution improves aesthetics thanks to its square and essential shape.

Save space system

Drain and siphon are designed to leave as much space as possible in the under-sink area, more and more useful today for theseparate waste collection systems.

Small radius

Bowls with squared shapes with a modern design and an increased capacity, for a minimal aesthetics connected with an extreme praticity.

Space waste fitting

The elegant SPACE steel cap closes the drain and leaves no visible residues collected in the basket below. Space also has a small footprint and allows the optimal use of the under-sink compartment.

TECHNICAL DATA

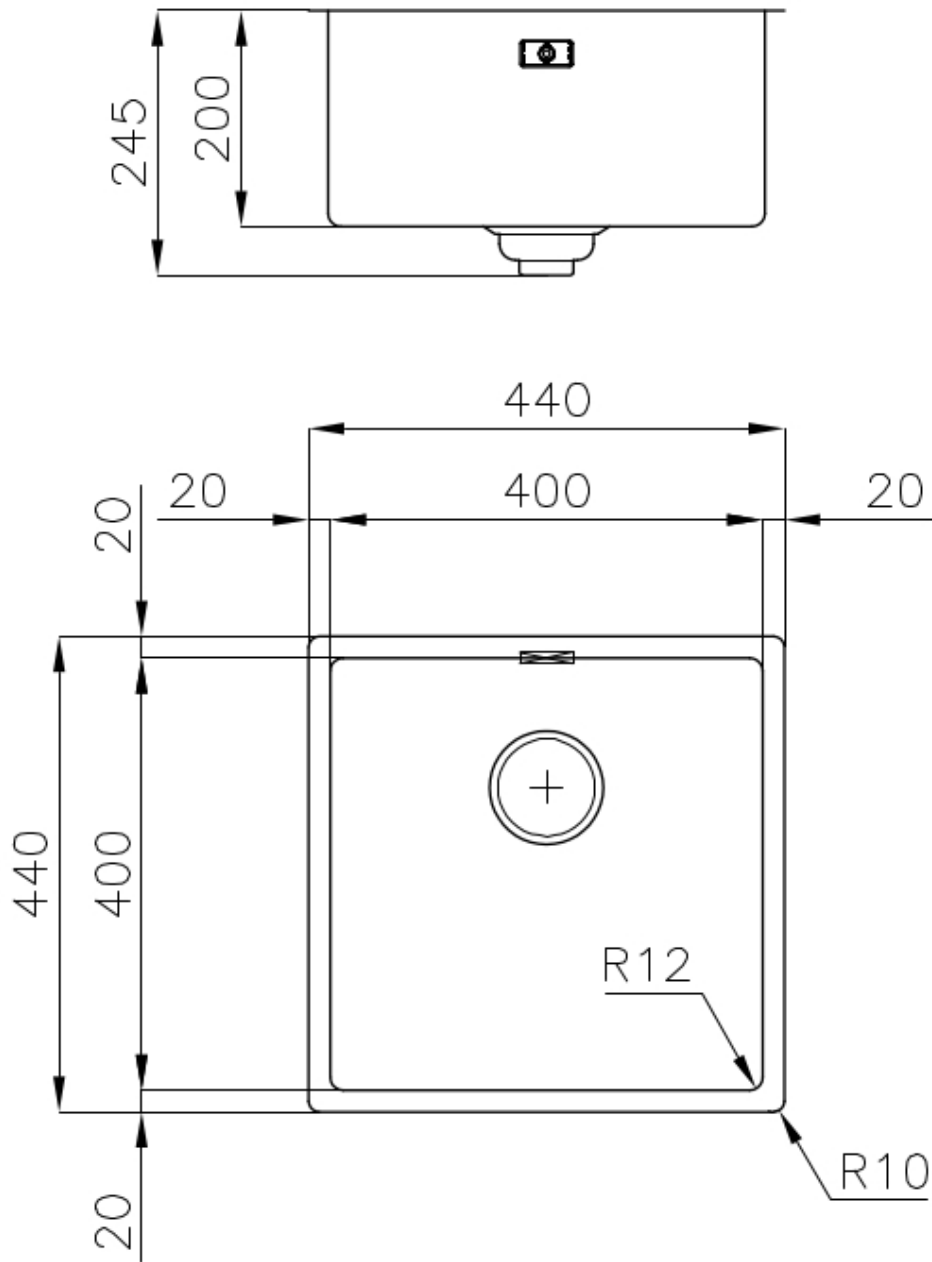

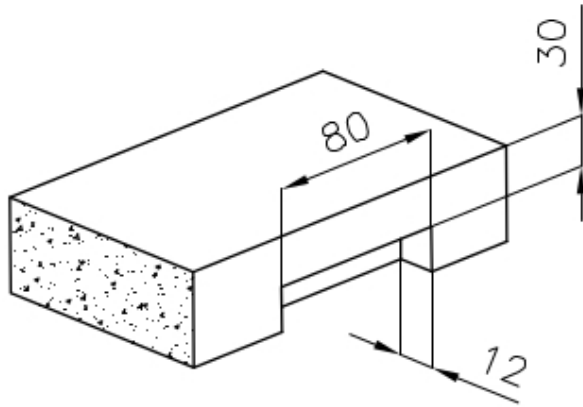

intaglio per il troppo-pieno
solo con top > 30 mm

recess for housing the over-flow
only for top > 30 mm

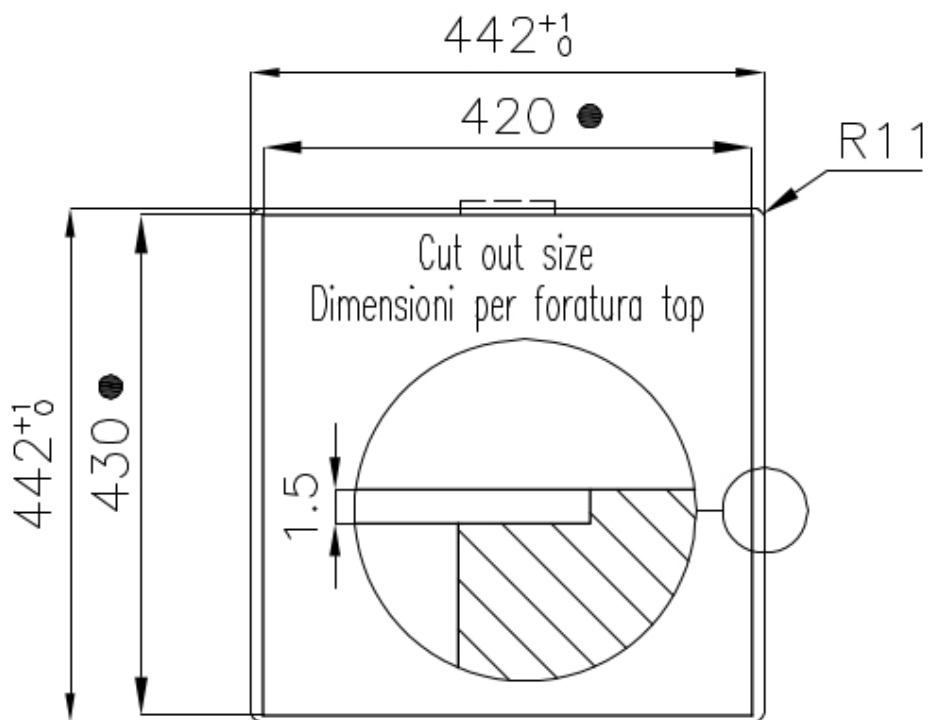

- Built-in cut out for FTS – Foratura per installazione FTS

GALLERY



OPTIONAL ACCESSORIES



Cestello inox 8612 000



Glass chopping board 8631 300



HPDE Chopping board 8657 001



HPDE Twin chopping board 8644 101



Iroko-wood chopping board with stainless steel colander 8644 042



Iroko-wood sliding chopping board 8644 041



Iroko-wood twin chopping board
8644 004



Stainless steel colander 8154 000



Stainless steel plate rack 8100 154

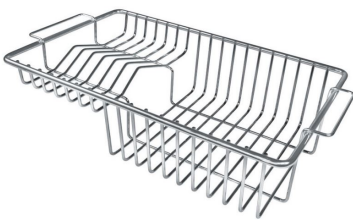

Stainless steel plate rack 8100 201

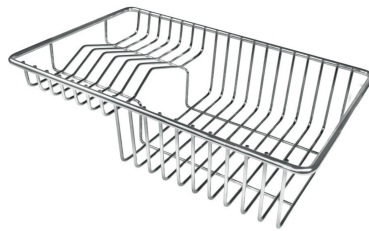

Stainless steel plate rack 8100 303



White bowl 8153 100



Graters kit with ring-holder and
food collection tray 8159 101



Stainless steel perforated tray
8151 000



White basket 8612 100

WARNING:

The accessories 8159101, 8151000 and 8100303 are only usable in combination with 8644101

The accessories 8100154 and 8154000 are only usable in combination with 8644004

RECOMMENDED PAIRINGS



Mixer Tap Skin Gun Metal 8424
856