

ART. COD. **A767**

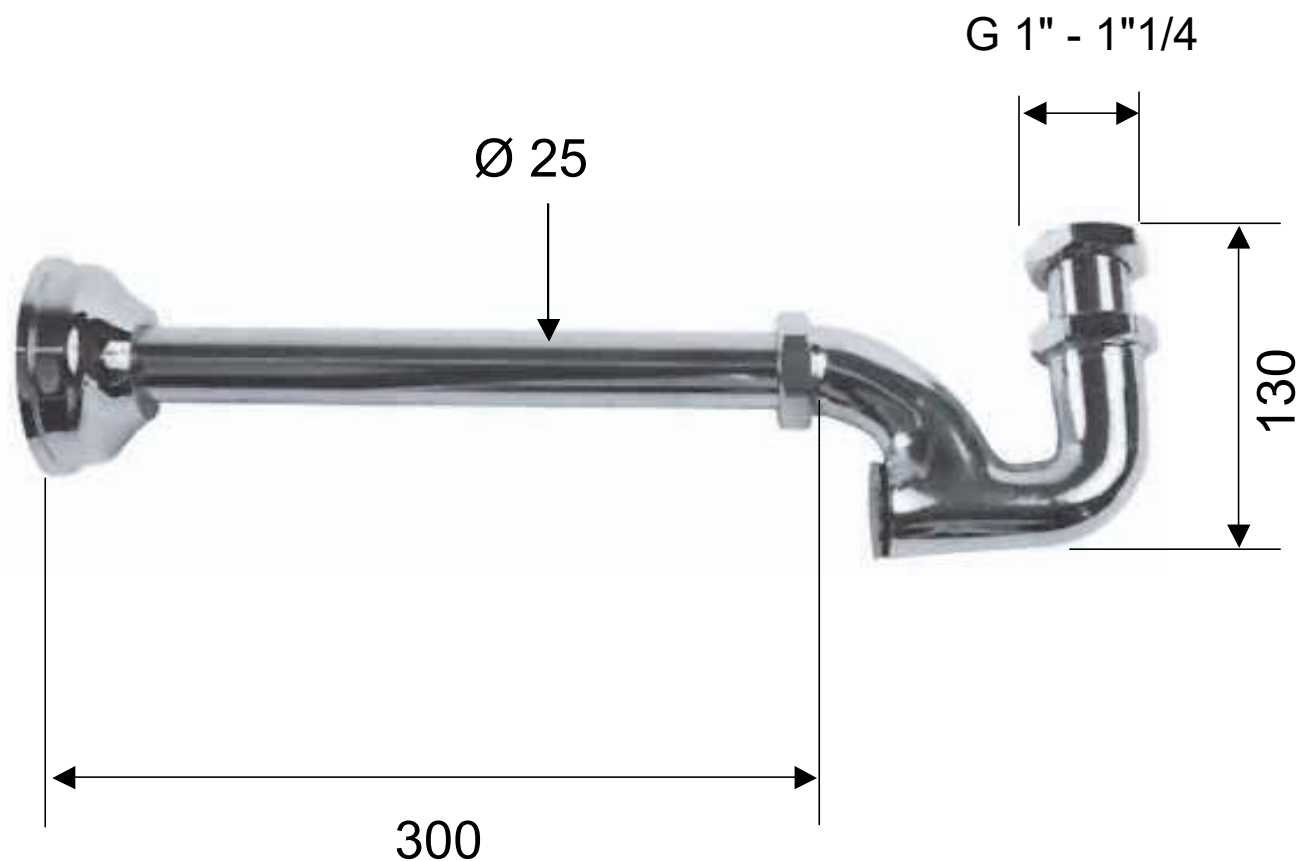

**MATERIALI / MATERIALS**

OTTONE CROMATO / CHROME PLATED BRASS

**CROMATURA / CHROME PLATING**

UNI EN 248