

Easy series

EasyPact™ CVS

Catalog 2021

Molded-case circuit breakers and
switch-disconnectors from 16 to 630A



<https://www.se.com>

Life Is On

Schneider
Electric



Green Premium™

An industry leading portfolio of offers delivering sustainable value



More than 75% of our product sales offer superior transparency on the material content, regulatory information and environmental impact of our products:

- RoHS compliance
- REACH substance information
- Industry leading # of PEP's*
- Circularity instructions



Discover what we mean by green
Check your products!

The Green Premium program stands for our commitment to deliver customer valued sustainable performance. It has been upgraded with recognized environmental claims and extended to cover all offers including Products, Services and Solutions.

CO₂ and P&L impact through... Resource Performance

Green Premium brings improved resource efficiency throughout an asset's lifecycle. This includes efficient use of energy and natural resources, along with the minimization of CO₂ emissions.

Cost of ownership optimization through... Circular Performance

We're helping our customers optimize the total cost of ownership of their assets. To do this, we provide IoT-enabled solutions, as well as upgrade, repair, retrofit, and remanufacture services.

Peace of mind through... Well-being Performance

Green Premium products are RoHS and REACH compliant. We're going beyond regulatory compliance with step-by-step substitution of certain materials and substances from our products.

Improved sales through... Differentiation

Green Premium delivers strong value propositions through third-party labels and services. By collaborating with third-party organizations we can support our customers in meeting their sustainability goals such as green building certifications.

*PEP: Product Environmental Profile (i.e. Environmental Product Declaration)



EasyPact CVS is... Safe

Isolation

- EasyPact CVS circuit breakers are suitable for Isolation as defined in IEC standards 60947-2. The aim of isolation is to separate a circuit or apparatus from the remainder of a system which is energized in order that personnel may carry out work on the isolated part in perfect safety.
- MCCB locking with external padlocks enables a user to isolate and undertake maintenance with utmost safety.



Isolation



Class II front Face

- All EasyPact CVS MCCBs are class II Front face devices, they may be installed through the door of class II switchboards without downgrading the switchboard insulation. Installation requires no special operation, even when the Circuit Breaker is equipped with a rotary handle.

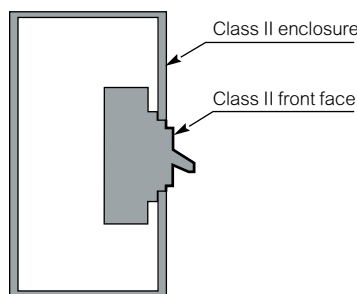

Class II panel with circuit breaker having a class II front face

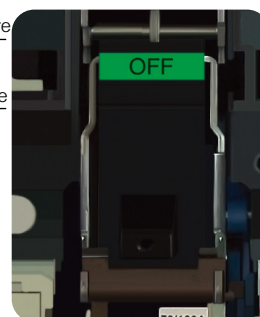

Locking in OFF position

- Key locks enable to lock the breaker in OFF position ensuring safety and better control on installation.
- It also helps in interlocking multiple circuit breakers in an installation.





EasyPact CVS is...Reliable



Conforms to IEC 60947-2 for circuit breaker

- Tested at renown international laboratories like KEMA
- Complete range with $I_{cs} = 100\% I_{cu}$



High electrical & Mechanical endurance

- 30000 mechanical operations for 100A
- 12000 electrical operations for 100A



Reliable accessories

- Continuous rated shunt coils
- Multifunctional Aux./Alarm contact
- Unique electrical fault trip indication (SDE)



EasyPact CVS offer protection for human as well as Electrical installation

- Earth leakage protection through Vigi Module to protect human against leakage current

Fault current limitation technology

- EasyPact CVS Double break mechanism ensures high fault current limitation
- @ Reduces thermal stresses on the electrical distribution network
- @ Increases the life of cables and installation

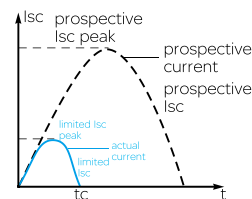

Current limitation technology

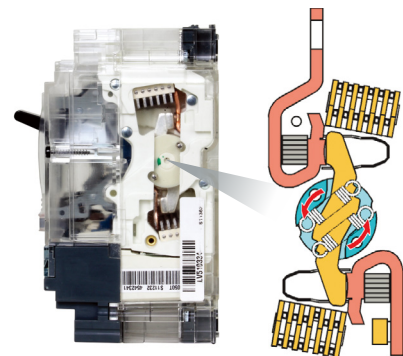

EasyPact CVS Double break Roto mechanism



EasyPact CVS is...Simple

Only two frame sizes
up to 630A

Frame - I 100 - 250A
Frame - II 400 - 630A

- Common and snap-fit accessories up to 630A
- Single OF contact for ON/OFF, Trip indication
- Single Shunt coil for remote tripping
- Single Under Voltage coil

- EasyPact CVS share same footprint of Compact Family MCCBs.
 - mounting dimensions
 - easy retrofitting
 - system upgradeability

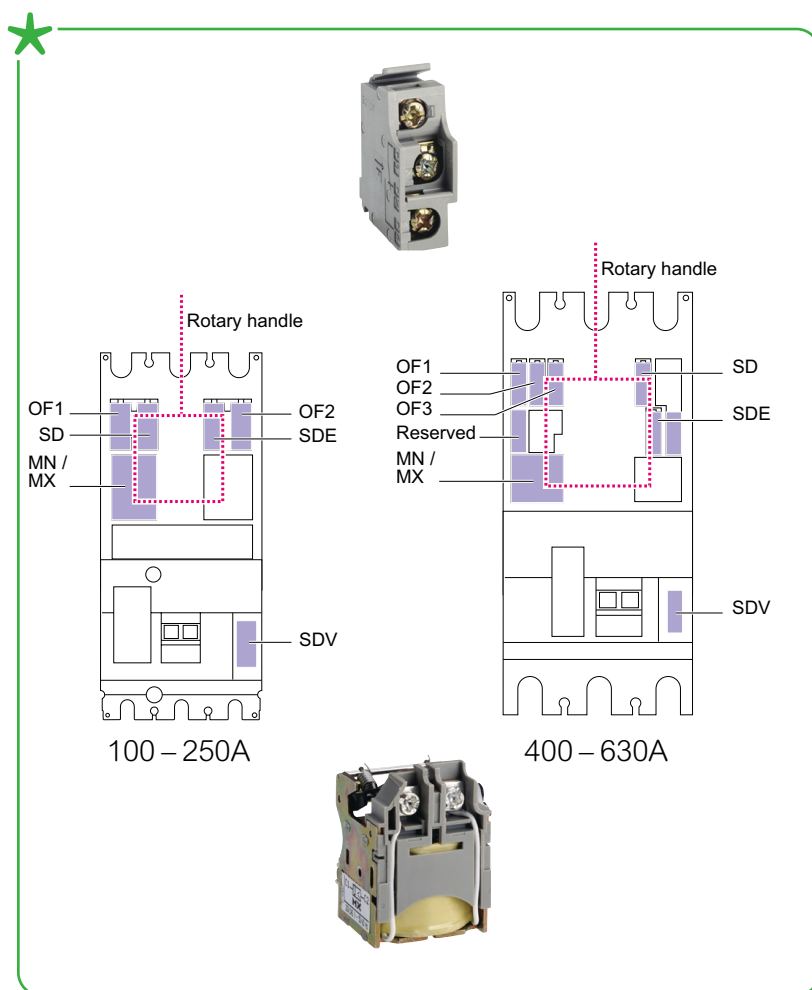

EasyPact CVS stands for customer value

EasyPact CVS 100 to 630 A



Panel builders

- Only two frame sizes up to 630A
- Common accessories for complete range (ON/OFF/Trip Auxiliaries/Shunt/UV etc)
- Line load reversibility for entire range
- Suitable for class II switchboards



End Users

- Isolation as a standard feature enhances safety
- Excellent current limiting capability reduces stresses on cables, busbars and loads
- Continuous rated accessories increase system reliability
- Modular earth leakage protection ensure human/installation protection



OEMs

- High endurance's and maintenance-free operation assure continuous performance of machines
- Unique common accessories help standardisation of components



Contractors

- Sufficient pole pitch helps to terminate Copper and Aluminum busbars or cables
- Easy availability of the product due to less number of frame size
- Designed to perform in demanding applications

- > Do you strain to find circuit breakers that are simple as well as flexible and safe?
- > Has it been difficult to find high quality circuit breakers at the right price point?
- > Do you need the reach, support and accessibility of a global leader, with the value of a local supplier?



Buildings



Industry

Gain peace of mind,
quality, and value for
your installations



General contents

EasyPact™ CVS

Presentation 1

Functions
and characteristics A-1

Installation
recommendations B-1

Dimensions
and connection C-1

Additional characteristics D-1

Catalogue numbers E-1

EasyPact CVS100BS F-1

Functions and characteristics



Functions and characteristics

Introduction	A-2
General characteristics	A-2
Characteristics and performance	A-4
Protection of distribution systems	A-6
TM-D thermal-magnetic trip units	A-6
TM-G thermal-magnetic trip units	A-7
ETS 2.3 electronic trip unit and accessories	A-8
Earth-leakage protection	A-9
Motor protection	A-11
MA instantaneous trip units	A-11
Switch-disconnectors	A-12
Accessories and auxiliaries	A-14
Overview	A-14
Device installation	A-15
Connection of devices	A-16
Selection of auxiliaries	A-18
Indication contacts	A-19
Remote tripping	A-20
Rotary handles	A-21
Locks and sealing accessories	A-22
Escutcheons and protection collars	A-23
<i>Installation recommendations</i>	<i>B-1</i>
<i>Dimensions and connection</i>	<i>C-1</i>
<i>Additional characteristics</i>	<i>D-1</i>
<i>Catalogue numbers</i>	<i>E-1</i>
<i>CVS100BS</i>	<i>F-1</i>

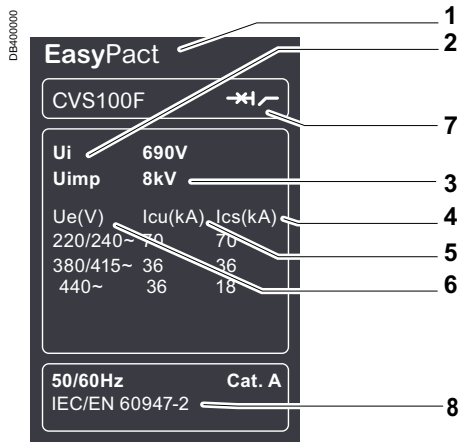

Standardised characteristics indicated on the rating plate:

- 1 Type of device: frame size and breaking capacity class
- 2 U_i : rated insulation voltage.
- 3 U_{imp} : rated impulse withstand voltage.
- 4 I_{cs} : service breaking capacity.
- 5 I_{cu} : ultimate breaking capacity for various values of the rated operational voltage U_e
- 6 U_e : operational voltage.
- 7 Suitable for Isolation symbol.
- 8 Reference standard.

Note: when the circuit breaker is equipped with an extended rotary handle, the door must be opened to access the rating plate.

Compliance with standards

EasyPact CVS circuit breakers and auxiliaries comply with the following international recommendations:

- IEC 60947-1: general rules
- IEC 60947-2: circuit breakers
- IEC 60947-3: switch-disconnectors

Pollution degree

EasyPact CVS circuit breakers are certified for operation in pollution-degree III environments as defined by IEC standards 60947-1 and 60664-1 (industrial environments).

Climatic withstand

EasyPact CVS circuit breakers have successfully passed the tests defined by the following standards for extreme atmospheric conditions:

- IEC 60068-2-1: dry cold (-55°C)
- IEC 60068-2-2: dry heat (+85°C)
- IEC 60068-2-30: damp heat (95 % relative humidity at 55°C)
- IEC 60068-2-52 severity level 2: salt mist.

Environment

EasyPact CVS respects the European environment directive EC/2002/95 concerning the restriction of hazardous substances (RoHS). All EasyPact CVS production sites have set up an ISO 14001 certified environmental management system.

Ambient temperature

- EasyPact CVS circuit breakers can be used between -25°C and +70°C. For temperatures higher than 40°C (65°C for circuit breakers used to protect motor feeders), devices must be derated ([see page B-2](#)).
- Circuit breakers should be put into service under normal ambient, operating-temperature conditions. Exceptionally, the circuit breaker can be put into service when the ambient temperature is between -35°C and -25°C.
- The permissible storage-temperature range for EasyPact CVS circuit breakers in the original packing is -50°C and +85°C.

Electromagnetic compatibility

EasyPact CVS circuit breakers with ETS2.3 electronic trip unit have successfully passed the tests defined by the following standards for EMC:

- IEC/EN 60947-2, Annex F: Immunity tests for circuit breakers with electronic protection

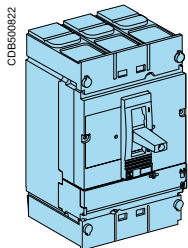

EasyPact CVS100/160/250/400/630
with terminal shields

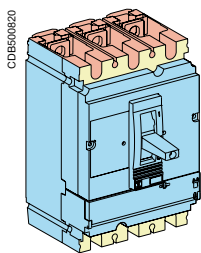

EasyPact CVS100/160/250

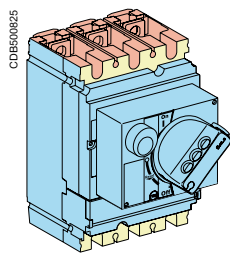

EasyPact CVS100/160/250
with direct rotary handle

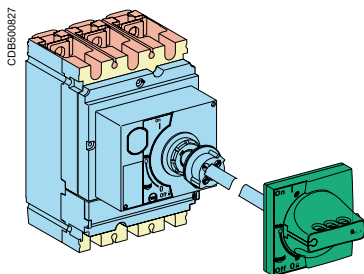

EasyPact CVS100/160/250 with extended rotary handle

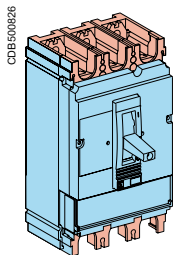

EasyPact CVS400/630

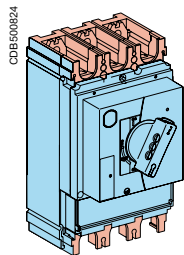

EasyPact CVS400/630 with direct rotary handle

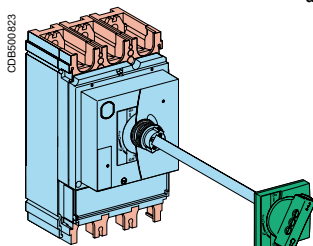

EasyPact CVS400/630 with extended rotary handle

Suitable for isolation with positive contact indication

All EasyPact CVS circuit breakers are suitable for isolation as defined in IEC standard 60947-2:

- The isolation position corresponds to the O (OFF) position.
- The operating handle cannot indicate the OFF position unless the contacts are effectively open.

- Padlocks cannot be installed unless the contacts are open.

Installation of a rotary handle does not alter the reliability of the position-indication system.

The isolation function is certified by tests guaranteeing:

- The mechanical reliability of the position-indication system

- The absence of leakage currents

- Over voltage withstand capacity between upstream and downstream connections.

The tripped position does not ensure isolation with positive contact indication.

Only the OFF position guarantees isolation.

Installation in class II switchboards

All EasyPact CVS circuit breakers are class II front face devices. They can be installed through the door of class II switchboards (as per IEC standards 61140 and 60664-1) without downgrading switchboard insulation. Installation requires no special operations, even when the circuit breaker is equipped with a rotary handle.

Degree of protection

The following indications are in accordance with standards IEC 60529 (IP degree of protection) and IEC 62262 (IK protection against external mechanical impacts).

Bare circuit breaker with Escutcheon:





- with toggle: IP40, IK07 front face
- with extended rotary handle: IP 54, IK08





Circuit breaker installed in a switchboard:

- with toggle: IP40, IK07 front face
- with extended rotary handle: IP 54, IK08

Protection degree

Protection degree of the product, according to IEC60259, depends on its configuration:

Colours	Definition
	IP54: front extended rotary handle
	IP40: front cover, side, back, terminal shield, direct rotary handle
	IP20: power connection cover
	maybe IP20 or less depending on the kind of power connections and cable size used

-  IP54
-  IP40
-  IP20
-  < IP20

PE106447



EasyPact CVS100/160/250

PE106448



EasyPact CVS400/630

Common characteristics

Rated voltages			
Insulation voltage (V)	Ui		690
Impulse withstand voltage (kV)	Uimp		8
Operational voltage (V)	Ue	AC 50/60 Hz	440
Suitability for isolation		IEC/EN 60947-2	yes
Utilisation category			A
Pollution degree		IEC 60664-1	3

Circuit breakers

Performance

Electrical characteristics as per IEC 60947-2

Rated current (A)	In	40 °C	
-------------------	-----------	-------	--

Number of poles

Breaking capacity levels

Breaking capacity (kA rms)			
Icu	AC 50/60 Hz	220/240 V	380/415 V
			440 V

Service breaking capacity (kA rms)			
Ics	AC 50/60 Hz	220/240 V	380/415 V
			440 V

Durability (C-O cycles)		Mechanical	
		Electrical	415V In/2 In

Protection

Short-circuit protection	Magnetic only
Overload/short-circuit protection	Thermal magnetic
	Electronic
	with neutral protection (Off-0.5-1)
Earth-leakage protection	By Vigi module

Installation/connections

Dimensions and weights		
Dimensions (mm)	Fixed, front connections	3P
W x H x D		4P
Weight (kg)	Fixed, front connections	3P
		4P

Connections

Connection terminals	Pitch	Without/ With spreaders
Large Cu or Al cables	Cross-section	mm ²

CVS100			CVS160			CVS250			CVS400		CVS630	
100			160			250			400		630	
3, 4			3, 4			3, 4			3, 4		3, 4	
B	F	N	B	F	N	B	F	N	F	N	F	N
40	70	90	40	70	90	40	70	90	40	70	40	70
25	36	50	25	36	50	25	36	50	36	50	36	50
20	36	50	20	36	50	20	36	50	30	42	30	42
40	70	90	40	70	90	40	70	90	40	70	40	70
25	36	50	25	36	50	25	36	50	36	50	36	50
15	18	38	15	18	38	15	18	38	23	32	23	32
30000			25000			20000			15000		15000	
30000			25000			20000			12000		8000	
12000			12000			10000			6000		4000	
■			■			■			■		■	
■			■			■			■		■	
-			-			-			■		■	
-			-			-			■		■	
■			■			■			■		■	
105 x 161 x 86			105 x 161 x 86			105 x 161 x 86			140 x 255 x 110		140 x 255 x 110	
140 x 161 x 86			140 x 161 x 86			140 x 161 x 86			185 x 255 x 110		185 x 255 x 110	
1.8			1.8			2.0			4.7		5.2	
2.2			2.3			2.6			6.3		7.1	
35/45 mm			35/45 mm			35/45 mm			45/52.5 mm		45/52.5 mm	
									45/70 mm		45/70 mm	
300			300			300			4 x 240		4 x 240	

Protection of distribution systems

TM-D thermal-magnetic trip units

TM-D thermal-magnetic trip units can be used on EasyPact CVS100-630 circuit breakers with performance levels B/F/N.

TM-D thermal-magnetic trip units

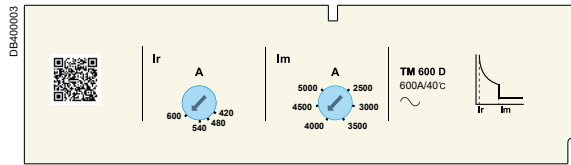

Protection

TM-D trip units are used mainly in electrical distribution applications for protection of cables supplied by transformers.

Thermal protection (Ir)

Thermal protection operates according to:

- Ir that can be adjusted in amps from 0.7 to 1 times the rating of the trip unit (16 A to 250 A), corresponding to settings from 11 to 250 A for the range of trip units
- a non-adjustable time delay.

Magnetic protection (Im)

Short-circuit protection with a fixed or adjustable pick-up Im that initiates instantaneous tripping if exceeded.

- TM-D: fixed pick-up, Im, for 16 to 250 A ratings and adjustable from 5 to 10 x In for 400 A ratings, 4.2 to 8.3 x In for 600 A rating.

Protection versions

- 3-pole:
 - 3P 3D: 3-pole frame (3P) with detection on all 3 poles (3D)
- 4-pole:
 - 4P 3D: 4-pole frame (4P) with detection on 3 poles (3D).
 - 4P 4D: 4-pole frame (4P) with detection on all 4 poles (same threshold for phases and neutral).

Thermal-magnetic trip units		TM16D to 250D											TM320D to 600D				
Ratings (A)	In at 40 °C ⁽¹⁾	16	25	32	40	50	63	80	100	125	160	200	250	320	400	500	600
Circuit breaker	CVS100	■	■	■	■	■	■	■	■	-	-	-	-				
	CVS160	-	-	-	-	-	-	-	■	■	■	-	-				
	CVS250	-	-	-	-	-	-	-	-	-	■	■	■				
	CVS400													■	■	-	-
	CVS630													-	-	■	■
Magnetic protection																	
Pick-up (A)	Im	fixed											adjustable				
accuracy ±20 %	CVS100	190	300	400	500	500	500	640	800								
	CVS160/250								800	1250	1250	2000	2500				
	CVS400													1600 to 3200 (320A), 2000 to 4000 (400A)			
	CVS630													2500 to 5000			
Thermal protection																	
Pick-up (A) tripping between 1.05 and 1.30 Ir	Ir = In x ...	adjustable in amps from 0.7 to 1 x In															
Neutral protection																	
Unprotected neutral	4P 3D	no detection															
Fully protected neutral	4P 4D	1 x Ir															

(1) For temperatures not equal to 40°C, the thermal protection characteristics are modified. See the temperature derating table on page B-2.

Note: All the trip units have a transparent lead-sealable cover that protects access to the adjustment dials.

TM-G thermal-magnetic trip units can be used on EasyPact CVS160-250 circuit breakers with performance levels B for the protection of generators or long cable length.

TM-G thermal-magnetic trip units

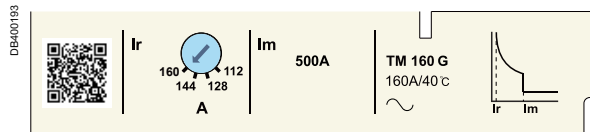

Protection

TM-G, with a low pick-up for generators (lower short-circuit currents than with transformers) and distribution system with long cable lengths (fault current limited by impedance of the cable).

Thermal protection (Ir)

Thermal protection operates according to:

- Ir that can be adjusted in amps from 0.7 to 1 times the rating of the trip unit (80 A to 250 A), corresponding to settings from 56 to 250 A for the range of trip units
- a non-adjustable time delay.

Magnetic protection (Im)

Short-circuit protection with a fixed Im that initiates instantaneous tripping if exceeded.

- TM-G: fixed pick-up, Im, for 80 to 250 A ratings.

Protection versions

- 3-pole:
 - 3P 3D: 3-pole frame (3P) with detection on all 3 poles (3D)
- 4-pole:
 - 4P 3D: 4-pole frame (4P) with detection on 3 poles (3D).

Thermal-magnetic trip units		TM80G to 250G						
Ratings (A)	In at 40 °C ⁽¹⁾	80	100	125	160	200	250	
Circuit breaker	CVS160	■	■	■	■	-	-	
	CVS250	-	-	-	-	■	■	
Magnetic protection								
Pick-up (A)	Im							
accuracy ±20 %	CVS160/250	200	320	440	500	600	750	
Thermal protection								
Pick-up (A)	Ir = In x ...	adjustable in amps from 0.7 to 1 x In						
tripping between 1.05 and 1.30 Ir								
Neutral protection								
Unprotected neutral	4P 3D	no detection						

Protection of distribution systems

ETS 2.3 electronic trip unit and accessories

ETS2.3 electronic trip unit

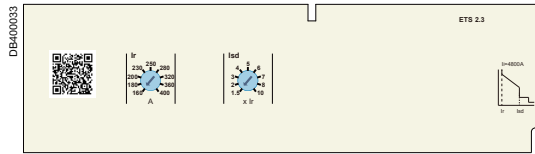

Circuit breakers equipped with ETS2.3 trip units can be used to protect distribution systems supplied by transformers.

Protection

Settings are made using the adjustment dials with adjustment possibilities.

Overloads: Long time protection (Ir)

Inverse time protection against overloads with an adjustable current pick-up Ir set using a dial and a non-adjustable time delay tr.

Short-circuits: Short-time protection with fixed time delay (Isd)

Protection with an adjustable pick-up Isd. Tripping takes place after a very short delay used to allow discrimination with the downstream device.

Short-circuits: Non-adjustable instantaneous protection

Instantaneous short-circuit protection with a fixed pick-up.

Neutral protection

- On 3-pole circuit breakers, neutral protection is not possible.
- On four-pole circuit breakers, neutral protection may be set using a three-position switch:
 - 4P 3D: neutral unprotected
 - 4P 3D + N/2: neutral protection at half the value of the phase pick-up, i.e. $0.5 \times I_r$
 - 4P 4D: neutral fully protected at Ir



Note: all the trip units have a transparent lead-sealable cover that protects access to the adjustment dials.

ETS2.3		400	630								
Ratings (A)	In at 40 °C (1)	400	630								
Circuit breaker	EasyPact CVS400	■	-								
	EasyPact CVS630	-	■								
L Long-time protection											
Pick-up (A)	Ir	value depending on trip unit rating (In) and setting on dial									
tripping between 1.05 and 1.20 Ir	In = 400 A	Ir =	160	180	200	230	250	280	320	360	400
	In = 630 A	Ir =	250	280	315	370	400	440	505	565	630
Time delay (s)	tr	keypad setting	non-adjustable								
accuracy 0 to -20 %		1.5 x Ir	200								
		6 x Ir	8								
		7.2 x Ir	5.5								
Thermal memory			20 minutes before and after tripping								
S₀ Short-time protection with fixed time delay											
Pick-up (A)	Isd = Ir x ...	1.5	2	3	4	5	6	7	8	10	
accuracy ±10 %		non-adjustable									
	tsd	non-adjustable									
	Non-tripping time	20									
	Maximum break time	80									
I Instantaneous protection											
Pick-up (A)	Ii non-adjustable	4800	6930								
accuracy ±15 %		10 ms									
	Maximum break time	50 ms for I > Ii									

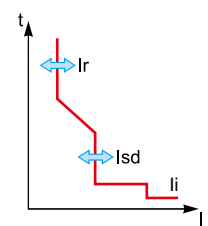

(1) If the trip units are used in high-temperature environments, the ETS2.3 setting must take into account the thermal limitations of the circuit breaker. See the temperature derating table.

Earth-leakage protection

Add-on protection against insulation faults using a Vigi module

A Vigi module can be added to any three or four-pole CVS100 to 630 circuit breaker to form a Vigi CVS.

Circuit breaker with add-on Vigi module (Vigi CVS)

- For general characteristics of circuit breakers, see pages A-2 and A-3.
- Add-on Vigi modules: Earth-leakage protection is achieved by installing a Vigi module (characteristics and selection criteria on next page) directly on the circuit breaker terminals. It directly actuates the trip unit (magnetic, thermal-magnetic or ETS).



PB106449

Vigi CVS100 to 630

Vigi CVS100 to 630 circuit breakers with earth-leakage protection

Addition of the Vigi module does not alter circuit-breaker characteristics:

- compliance with standards
- degree of protection, class II front-face insulation
- positive contact indication
- electrical characteristics
- trip-unit characteristics
- installation and connection modes
- indication, measurement and control auxiliaries
- installation and connection accessories.

Dimensions and weights		CVS100/160/250	CVS400/630
Dimensions	3-pole	105 x 236 x 86	140 x 355 x 110
W x H x D (mm)	4-pole	140 x 236 x 86	185 x 355 x 110
Weight (kg)	3-pole	2.5	8.8
	4-pole	3.2	10.8

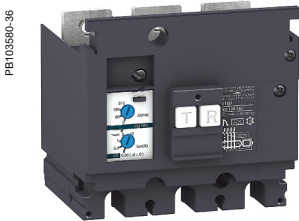

PB103580-36

Vigi earth-leakage protection modules

Compliance with standards

- IEC 60947-2, annex B.
- Decree dated 14 November 1988 (for France).
- IEC 60755, class A, immunity to DC components up to 6 mA
- operation down to -25 °C as per VDE 664.

Earth-leakage protection

Add-on protection against insulation faults using a Vigi module

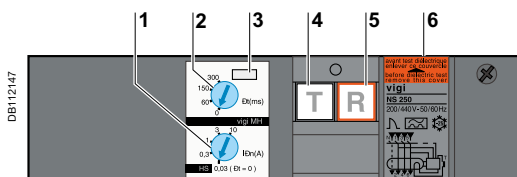

- 1 Sensitivity setting
- 2 Time-delay setting (for selective earth-leakage protection).
- 3 Lead-seal fixture for controlled access to settings.
- 4 Test button simulating an earth-fault for regular checks on the tripping function
- 5 Reset button (reset required after earth-fault tripping).
- 6 Rating plate

Vigi module selection

Type	CVS100/160/250	CVS400/630
Number of poles	3, 4 ⁽¹⁾	3, 4 ⁽¹⁾
Protection characteristics		
Sensitivity	adjustable	adjustable
$I\Delta n$ (A)	0.03 - 0.3 - 1 - 3 - 10	0.3 - 1 - 3 - 10 - 30
Time delay	adjustable	adjustable
Intentional delay (ms)	0 - 60 ⁽²⁾ - 150 ⁽²⁾ - 300 ⁽²⁾	0 - 60 - 150 - 300
Max. break time (ms)	< 40 < 140 < 300 < 800	< 40 < 140 < 300 < 800
Rated voltage V AC 50/60 Hz	200... 440	200...440

- ⁽¹⁾ Vigi 3P modules may also be used on 3P circuit breakers used for two-phase protection.
⁽²⁾ If the sensitivity is set to 30 mA, there is no time delay, whatever the time-delay setting.

Operating safety

The Vigi module is a user safety device. It must be tested at regular intervals (every 6 months) via the test button.

MA magnetic trip units for EasyPact CVS100-630A

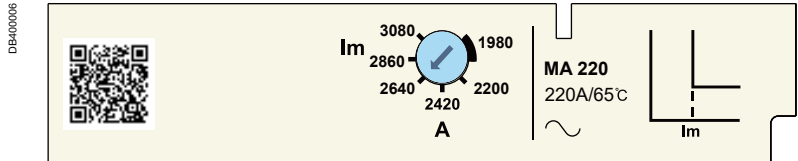

Circuit breakers with an MA trip unit are combined with a thermal relay and a contactor or a starter.

Protection

Magnetic protection (Im)

Short-circuit protection with an adjustable pick-up I_m that initiates instantaneous tripping if exceeded.

■ $I_m = I_n \times \dots$ is set on an adjustment dial in multiples of the rating:

- 6 to 14 x I_n (2.5 to 100 A ratings)
- 9 to 14 x I_n (150 to 220 A ratings)
- 6 to 13 x I_n (320 to 500 A ratings)

Protection version

- 3-pole (3P 3D): 3-pole frame (3P) equipped with detection on all 3 poles (3D).

Motor protection up to 250 kW

Motor protection rating (kW)

CVS 100/160/250		1.1...110	
CVS 400/630			18.5...250
Breaking capacity (kA rms)	B	25	-
	F	36	36
	N	50	50

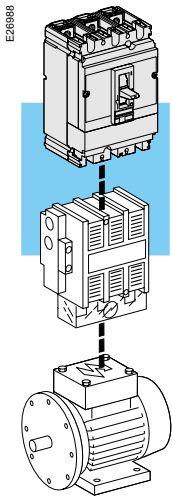

CVS100 to 630 circuit breakers, equipped with an MA magnetic trip unit with adjustable thresholds, offer:

- short-circuit protection
- suitability for isolation.

CVS100 to 630 circuit breakers with trip unit are supplied ready-assembled.

MA trip units		2.5	6.3	12.5	25	50	100	150	220	320	500
Ratings (A)	I_n at 65 °C										
Circuit breaker	CVS100	■	■	■	■	■	■	-	-	-	-
	CVS160	-	-	-	-	-	■	■	-	-	-
	CVS250	-	-	-	-	-	-	■	■	-	-
	CVS400	-	-	-	-	-	-	-	-	■	-
	CVS630	-	-	-	-	-	-	-	-	-	■
Short-circuit protection (magnetic)											
Pick-up (A)	$I_m = I_n \times \dots$	setting						setting		setting	
CVS100		6...14 x I_n									
CVS160/250								9...14 x I_n			
CVS400/630										6...13 x I_n	

Installation standards require upstream protection. However **EasyPact CVS100 to 630 NA** switch-disconnectors are self-protected by their high-set magnetic release.

PE106451



EasyPact CVS100 to 250 NA

PE106452



EasyPact CVS400 to 630 NA

Switch-disconnectors

Electrical characteristics as per IEC 60947-3 and EN 60947-3

Conventional thermal current (A)	I_{th}	50 °C	
Number of poles			
Operational current (A) depending on the utilisation category	I_e	AC 50/60 Hz	220/240 V
			380/415 V
			440 V
Short-circuit making capacity (kA peak)	I_{cm}		min. (switch-disconnector alone)
			max. (protection by upstream circuit breaker)
Rated short-time withstand current (A rms)	I_{cw}	for	1 s
			3 s
			20 s
Durability (C-O cycles)		mechanical	
		electrical	AC
			415 V
			In

Protection

Add-on earth-leakage protection By Vigi module

Additional indication and control auxiliaries

Indication contacts	
Voltage releases	MX shunt release MN undervoltage release

Installation/connections

Dimensions (mm)	fixed, front connections	3P
W x H x D		4P
Weight (kg)	fixed, front connections	3P
		4P

CVS100NA	CVS160NA	CVS250NA	CVS400NA	CVS630NA
100	160	250	400	630
3, 4	3, 4	3, 4	3, 4	3, 4
AC22A / AC23A	AC22A / AC23A	AC22A / AC23A	AC22A / AC23A	AC22A / AC23A
100	160	250	400	630/500
100	160	250	400	630/500
100	160	250	400	630/500
2.6	3.6	4.9	7.1	8.5
75	75	75	105	105
1800	2500	3500	5000	6000
1800	2500	3500	5000	6000
690	960	1350	1930	2320
30000	25000	20000	15000	15000
AC22A / AC23A	AC22A / AC23A	AC22A / AC23A	AC22A / AC23A	AC22A / AC23A
8000	8000	6500	4000	2500
■			■	
■			■	
■			■	
■			■	
105 x 161 x 86			140 x 255 x 110	
140 x 161 x 86			185 x 255 x 110	
1.5 to 1.8			5.2	
2.0 to 2.2			6.8	

Insulation accessories ▶ E-9, E-15

DE-400001

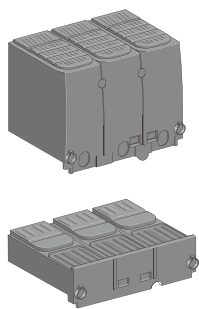

Sealable terminal shields



Interphase barriers

Connection ▶ A-16

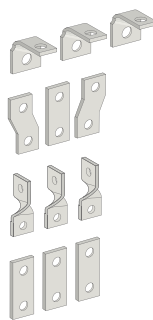

Terminal extensions

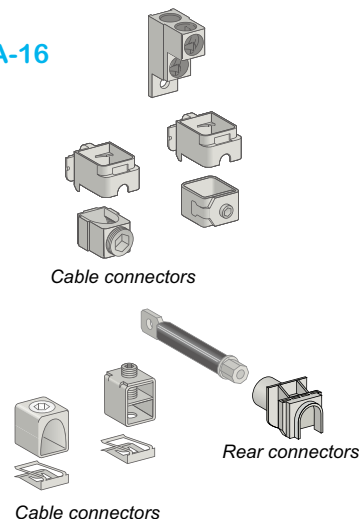

Cable connectors

Cable connectors

Rear connectors

Electrical auxiliaries ▶ A-17



Indication contact



Voltage release

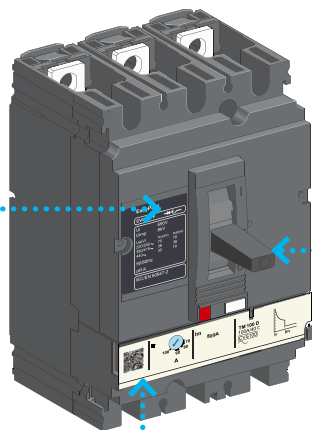

Monitoring ▶ A-8

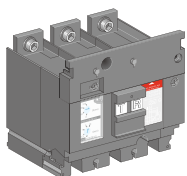

Earth leakage protection (VigiCVS)

Control accessories ▶ A-19

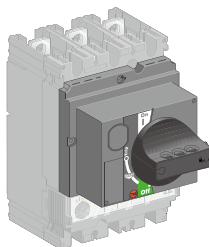

Direct rotary handle

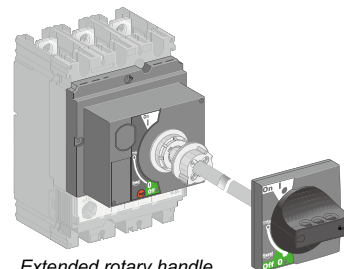

Extended rotary handle

CVS circuit breakers may be installed horizontally, vertically or flat on their back, without derating performance levels.

Fixed circuit breakers

Fixed circuit breakers are designed for standard connection using bars or cables with lugs. Bare-cable connectors are available for connection to bare copper or aluminium cables.

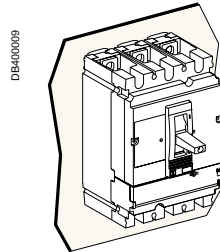

Mounting on a backplate.

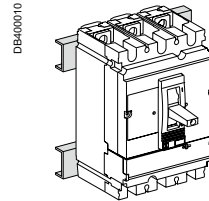

Mounting on rails.

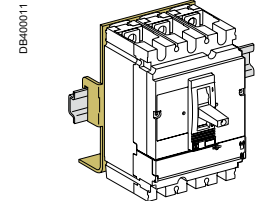

Mounting on DIN rail (with adaptor).

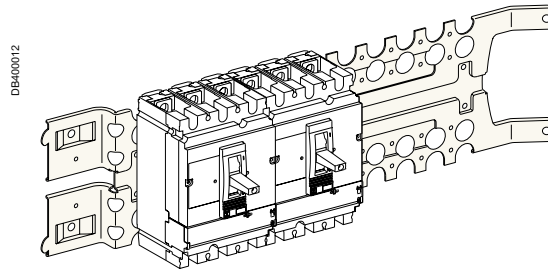

Mounting on a Prisma mounting plate.

Fixed circuit breakers are designed for standard front connection using bars or cables with lugs. Cable connectors are available for bare cables. Rear connection is also possible.

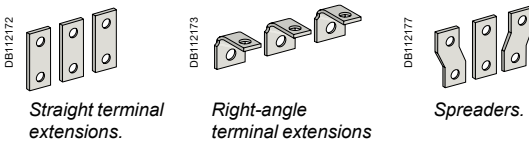
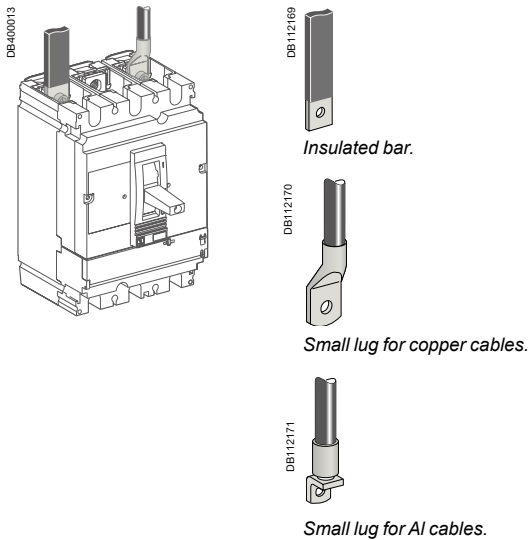

Front connection

Bars or cables with lugs

Standard terminals

EasyPact CVS100 to 630 come with terminals comprising snap-in nuts with screws:

- EasyPact CVS100: M6 nuts and screws.
- EasyPact CVS160/250: M8 nuts and screws
- EasyPact CVS400/630: M10 nuts and screws.

These terminals may be used for:

- direct connection of insulated bars or cables with lugs
- terminal extensions.

Interphase barriers or terminal shields are recommended. They are mandatory for certain connection accessories (in which case the interphase barriers are provided).

Bars

When the switchboard configuration has not been tested, insulated bars are mandatory.

Maximum size of bars

EasyPact CVS circuit breaker	100/160/250	400/630
Without spreaders	pitch (mm)	35
	maximum bar size (mm)	20 x 3
With spreaders	pitch (mm)	45
	maximum bar size (mm)	32 x 2

Crimp lugs

There are two modules of lugs, for aluminium and copper cables.

Interphase barriers or long terminal shields must be used with narrow lugs. The lugs are supplied with interphase barriers.

EasyPact CVS circuit breaker	100/160/250	400/630
Copper cables	size (mm ²)	150, 185
	crimping	hexagonal barrels or punching
Aluminium cables	size (mm ²)	150, 185
	crimping	hexagonal barrels

Terminal extensions

Extensions with anti-rotation ribs can be attached to the standard terminals to provide numerous connection possibilities in little space:

- straight terminal extensions
- right-angle terminal extensions

Spreaders

Spreaders may be used to increase the pitch:

- CVS100 to 250: the 35 mm pitch can be increased to 45 mm
- CVS400/630: the 45 mm pitch can be increased to 52 or 70 mm.

Bars, cable lugs or cable connectors can be attached to the ends.

Pitch (mm) depending on the type of spreader

EasyPact CVS circuit breaker	CVS100 to 250	CVS100 to 630
Without spreaders	35	45
With spreaders	45	52.5 or 70

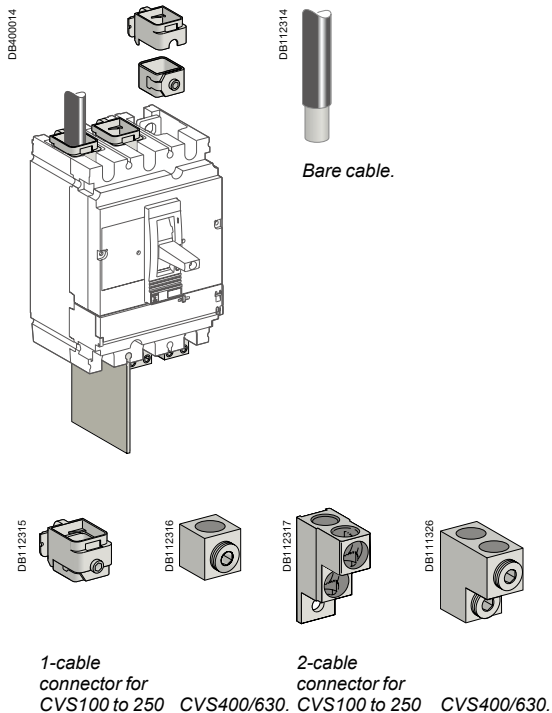

Bare cables

Bare-cable connectors may be used for both copper and aluminium cables.

1-cable connectors for EasyPact CVS100 to 250

The connectors snap directly on to the device terminals or are secured by clips to right-angle and straight terminal extensions as well as spreaders.

1-cable connectors for EasyPact CVS400 to 630

The connectors are screwed directly to the device terminals.

2-cable connectors for EasyPact CVS100 to 250 and 400/630

The connectors are screwed to device terminals or right-angle terminal extensions.

Maximum size of cables depending on the type of connector

EasyPact CVS circuit breaker		100/160	250	400	630
Steel connectors	1.5 to 95 mm ²	■			
Aluminium connectors	25 to 95 mm ²	■	■		
	120 to 185 mm ²	■	■		
	2 cables 50 to 120 mm ²	■	■		
	2 cables 35 to 240 mm ²			■	■
	35 to 300 mm ²			■	■

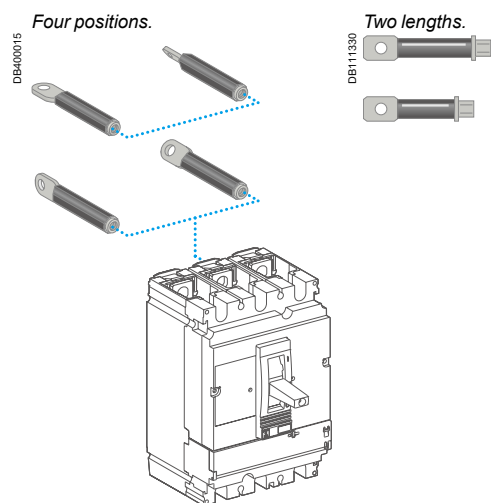

Rear connection

Device mounting on a backplate with suitable holes enables rear connection.

Bars or cables with lugs

Rear connections for bars or cables with lugs are available in two lengths. Bars may be positioned flat, on edge or at 45° angles depending on how the rear connections are positioned.

The rear connections are simply fitted to the device connection terminals. All combinations of rear connection lengths and positions are possible on a given device.

DB115693

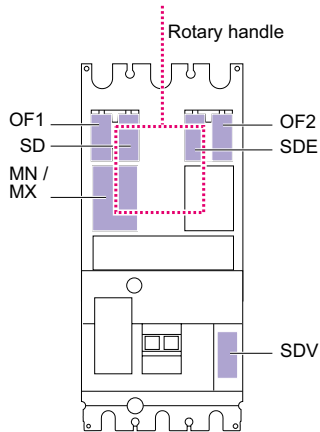

EasyPact CVS100/160/250

Standard

All EasyPact CVS100/160/250 circuit breakers and switch-disconnectors have slots for the electrical auxiliaries listed below.

5 indication contacts (see page A-17)

- 2 ON/OFF (OF1 and OF2)
- 1 trip indication (SD)
- 1 fault-trip indication (SDE)
- 1 earth-fault indication (SDV), when the device is equipped with a Vigi module.

1 remote-tripping release (see page A-18)

- either 1 MN undervoltage release
- or 1 MX shunt release.

All these auxiliaries can be installed with a rotary handle.

DB115690

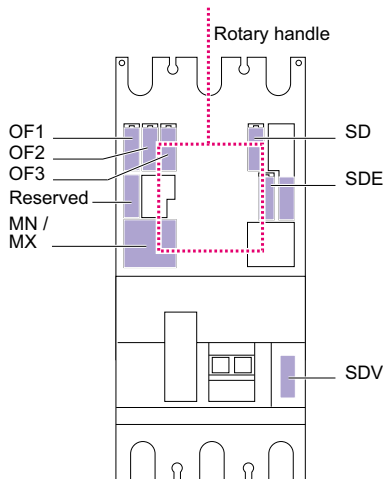

EasyPact CVS400/630

Standard

All EasyPact CVS400/630 circuit breakers and switch-disconnectors have slots for the electrical auxiliaries listed below.

6 indication contacts (see page A-17)

- 3 ON/OFF (OF3)
- 1 trip indication (SD)
- 1 fault-trip indication (SDE)
- 1 earth-fault indication (SDV), when the device is equipped with a Vigi module.

1 remote-tripping release (see page A-18)

- either 1 MN undervoltage release
- or 1 MX shunt release.

All these auxiliaries can be installed with a rotary handle.

The illustration shown (TMD, MA, NA and ETS 2.3 standard) indicates auxiliary possibilities depending on the type of trip unit.

One contact model provides circuit-breaker status indications (OF - SD - SDE - SDV).



Indication contacts.

These common-point changeover contacts provide remote circuit-breaker status information.

They can be used for indications, electrical locking, relaying, etc. They comply with the IEC 60947-5 international recommendation.

Functions

Breaker-status indications, during normal operation or after a fault

A single type of contact provides all the different indication functions:

- OF (ON/OFF) indicates the position of the circuit breaker contacts
- SD (trip indication) indicates that the circuit breaker has tripped due to:
 - an overload
 - a short-circuit
 - an earth fault (Vigi)
 - operation of a voltage release
 - operation of the “push to trip” button
 - disconnection when the device is ON.

The SD contact returns to de-energised state when the circuit breaker is reset.

- SDE (fault-trip indication) indicates that the circuit breaker has tripped due to:
 - an overload
 - a short-circuit
 - an earth fault (Vigi)
- SDV indicates that the circuit breaker has tripped due to an earth fault. It returns de-energised state when the Vigi module is reset.

Installation

■ OF, SD, SDE and SDV functions: a single type of contact provides all these different indication functions, depending on where it is inserted in the device. The contacts clip into slots behind the front cover of the circuit breaker (or the Vigi module for the SDV function).

The SDE function on a CVS100 - 630 A equipped with a magnetic, thermal-magnetic or ETS2.3 trip unit requires the SDE adaptor.

Electrical characteristics of auxiliary contacts

Contacts		Standard				Low level			
Types of contacts		All				OF, SD, SDE, SDV			
Rated thermal current (A)		6				5			
Minimum load		100 mA at 24 V DC				1 mA at 4 V DC			
Utilisation cat. (IEC 60947-5-1)		AC12	AC15	DC12	DC14	AC12	AC15	DC12	DC14
Operational current (A)	24 V AC/DC	6	6	6	1	5	3	5	1
	48 V AC/DC	6	6	2.5	0.2	5	3	2.5	0.2
	110 V AC/DC	6	5	0.6	0.05	5	2.5	0.6	0.05
	220/240 V AC	6	4	-	-	5	2	-	-
	250 V DC	-	-	0.3	0.03	5	-	0.3	0.03
	380/440 V AC	6	2	-	-	5	1.5	-	-



MX or MN voltage release.

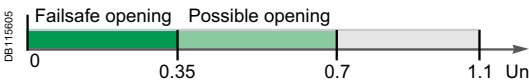

Opening conditions of the MN release.



Closing conditions of the MN release.



MN release with a time-delay unit.

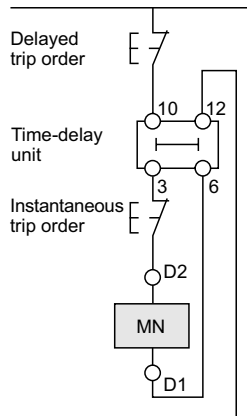

Wiring diagram for emergency-off function with MN + time-delay unit.

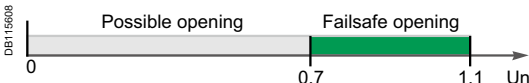

Opening conditions of the MX release.

MN undervoltage release

- This release trips the circuit breaker when the control voltage drops below a tripping threshold
- The tripping threshold is between 0.35 and 0.7 times the rated voltage
- Circuit breaker closing is possible only if the voltage exceeds 0.85 times the rated voltage.

Characteristics

Power supply	V AC	50/60 Hz: 24 - 48 - 100/130 - 200/240
		50 Hz: 380/415 60 Hz: 208/277
Operating threshold	V DC	12 - 24 - 30 - 48 - 60 - 125 - 250
	Opening	0.35 to 0.7 Un
	Closing	0.85 Un
Operating range		0.85 to 1.1 Un
Consumption (VA or W)		Pick-up: 10 - Hold: 5
Response time (ms)		50

Time-delay unit for an MN release

A time delay unit for the MN release eliminates the risk of nuisance tripping due to a transient voltage dip lasting ≤ 200 ms. For shorter micro-outages, a system of capacitors provides temporary supply to the MN at $U > 0.7$ to ensure no tripping. The correspondence between MN releases and time-delay units is shown below.

Power supply	Corresponding MN release
Unit with fixed delay 200 ms	
48 V AC	48 V DC
220 / 240 V AC	250 V DC
Unit with adjustable delay (0.5s, 0.9s, 1.5s, 3s)	
48 - 60 V AC/DC	48 V DC
100 - 130 V AC/DC	125 V DC
220 - 250 V AC/DC	250 V DC

MX shunt release

The MX release opens the circuit breaker via an impulse-type (≥ 20 ms) or maintained order.

Opening conditions

When the MX release is supplied, it automatically opens the circuit breaker. Opening is ensured for a voltage $U \geq 0.7 \times U_n$.

Characteristics

Power supply	V AC	50/60 Hz: 24 - 48 - 100/130 - 200/240
		50 Hz: 380/415 60 Hz: 208/277
Operating range	V DC	12 - 24 - 30 - 48 - 60 - 125 - 250
		0.7 to 1.1 Un
Consumption (VA or W)		Pick-up: 10
Response time (ms)		50

Circuit breaker control by MN or MX

When the circuit breaker has been tripped by an MN or MX release, it must be reset before it can be reclosed.

MN or MX tripping takes priority over manual closing.

In the presence of a standing trip order, closing of the contacts, even temporary, is not possible.

Connection using wires up to 1.5mm² to integrated terminal blocks.

Note: circuit breaker opening using an MN or MX release must be reserved for safety functions. This type of tripping increases wear on the opening mechanism. Repeated use reduces the mechanical endurance of the circuit breaker by 50 %.

There are two types of rotary handle:

- direct rotary handle
- extended rotary handle.



EasyPact CVS with a rotary handle.



EasyPact CVS with an extended rotary handle installed at the back of a switchboard, with the keylock option and key.

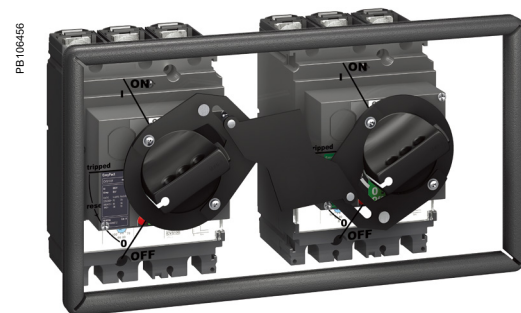

Direct rotary handle

Standard handle

Degree of protection IP40, IK07.

The direct rotary handle maintains:

- visibility of and access to trip-unit settings
- suitability for isolation
- indication of the three positions O (OFF), I (ON) and tripped
- access to the "push to trip" button.

Device locking

The rotary handle facilitates circuit-breaker locking.

■ Padlocking:

- standard situation, in the OFF position, using 1 to 3 padlocks, shackle diameter 5 to 8 mm, not supplied

Extended rotary handle

Degree of protection IP54, IK08.

The extended rotary handle makes it possible to operate circuit breakers installed at the back of switchboards, from the switchboard front.

It maintains:

- visibility of and access to trip-unit settings
- suitability for isolation
- indication of the three positions O (OFF), I (ON) and tripped.

Device and door padlocking

Padlocking locks the circuit-breaker handle and disables door opening:

- standard situation, in the OFF position, using 1 to 3 padlocks, shackle diameter 5 to 8 mm, not supplied

Parts of the extended rotary handle

- A unit that replaces the front cover of the circuit breaker (secured by screws).
- An assembly (handle and front plate) on the door that is always secured in the same position, whether the circuit breaker is installed vertically or horizontally.
- An extension shaft that must be adjusted to the distance. The min/max distance between the back of circuit breaker and door is:
 - 185...600 mm for EasyPact CVS100 to 250
 - 209...600 mm for EasyPact CVS 400/630.

Manual source-changeover systems

Additional accessory interlocks two devices with rotary handle to create a source-changeover system. Closing of one device is possible only if the second is open.

This function is compatible with direct or extended rotary handles.

Up to three padlocks can be used to lock in the OFF or ON position.

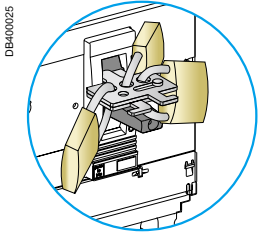

Toggle locking using padlocks and an accessory:
Removable device

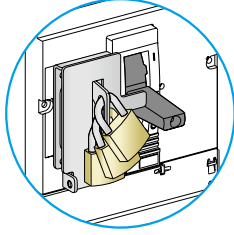

Fixed device attached to the case.

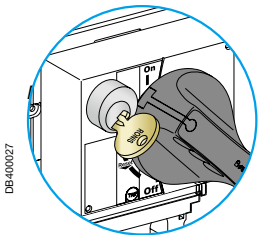

Rotary-handle locking using a keylock.

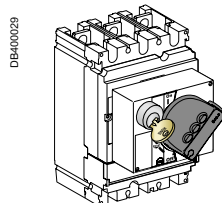
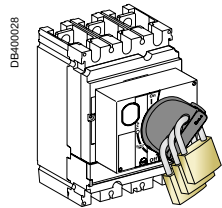

Rotary-handle locking using a padlock or a keylock.

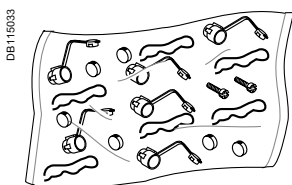

Sealing accessories.

Locks

Locking in the OFF position guarantees isolation as per IEC 60947-2. Padlocking systems can receive up to three padlocks with shackle diameters ranging from 5 to 8 mm (padlocks not supplied). Certain locking systems require an additional accessory.

Control device	Function	Means	Required accessories
Toggle	Lock in OFF position	Padlock	Removable device
	Lock in OFF or ON position	Padlock	Fixed device
Direct rotary handle	Standard	Lock in ■ OFF position ■ OFF or ON position ⁽¹⁾	Padlock - Keylock Locking device + keylock
Extended rotary handle	Lock in ■ OFF position ■ OFF or ON position ⁽¹⁾ with door opening prevented ⁽²⁾	Padlock	-
	Lock in OFF position ■ OFF or ON position ⁽¹⁾ inside the switchboard	Padlock Keylock	UL508 control accessory Locking device + keylock

⁽¹⁾ Following a simple modification of the mechanism.
⁽²⁾ Unless door locking has been voluntarily disabled.

Sealing accessories

Toggle control	
Rotary handle	
Access to Vigi-module settings	
Types of seals	<p>Protection cover for settings</p> <ul style="list-style-type: none"> ■ modification of settings.
Protected operations	

Accessories and auxiliaries

Escutcheons and protection collars

Escutcheons are an optional feature mounted on the switchboard door. They increase the degree of protection to IP40, IK07. Protection collars maintain the degree of protection, whatever the position of the device (connected, disconnected).

IP40 escutcheons for fixed devices

There are three types of an escutcheon with a gasket which are screwed to the door cut-out:

- three escutcheons for all control types (toggle, handle or motor mechanism)
- a wide model for Vigi modules that can be combined with the above.

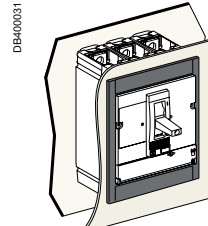
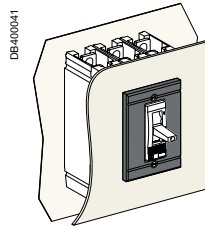

Escutcheon for toggle without and with access to the trip unit.

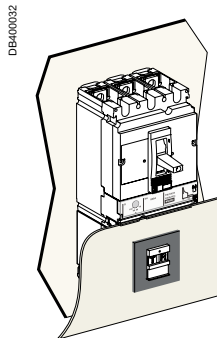

Escutcheon for Vigi module.

Installation recommendations



Installation recommendations

Functions and characteristics A-1

Operating conditions and temperature derating B-2

Installation in switchboards B-4

Power supply and weights B-4

Safety clearances and minimum distances B-5

Installation example B-6

Power loss/Resistance B-8

Dimensions and connection C-1

Additional characteristics D-1

Catalogue numbers E-1

EasyPact CVS100BS F-1

When thermal-magnetic trip units are used at ambient temperatures other than 40 °C, the Ir pick-up is modified.

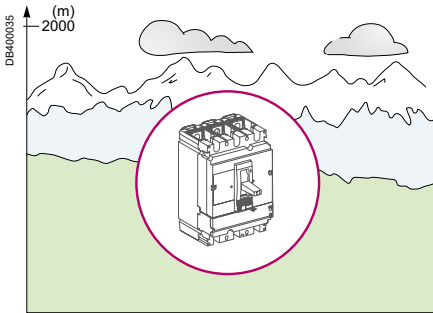

Electronic trip units are not affected by variations in temperature. If the trip units are used in high-temperature environments, the ETS setting must nevertheless take into account the temperature limits of the circuit breaker.

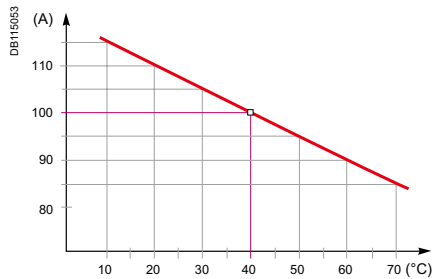

Temperature derating curve for CVS100.

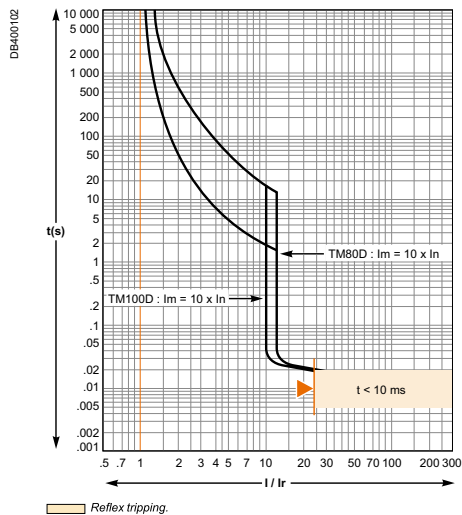

Reflex tripping.

Thermal-protection curve with minimum and maximum values.

Altitude derating

Altitude does not significantly affect the characteristics of EasyPact CVS circuit breakers up to 2000 m. Above this altitude, it is necessary to take into account the decrease in the dielectric strength and cooling capacity of air.

Altitude (m)	2000	3000	4000	5000	
Impulse withstand voltage Uimp (kV)	8	7	6	5.2	EasyPact CVS 100-630
Current ratio	1,00	0,96	0,93	0,90	
Ui	690	600	520	450	
Ue	440	400	400	380	

Vibrations

CVS devices resist electromagnetic or mechanical vibrations.

Tests are carried out in compliance with standard IEC 60068-2-6 for the levels required by merchant-marine inspection organisations (Veritas, Lloyds, etc.):

- 2 to 13.2 Hz: amplitude ±1 mm
- 13.2 to 100 Hz: constant acceleration 0.7 g.

Excessive vibration may cause tripping, breaks in connections or damage to mechanical parts.

Degree of protection

CVS circuit breakers have been tested for degree of protection (IP) and mechanical impact protection (IK). See page A-3.

The overload protection is calibrated at 40 °C in the lab. This means that when the ambient temperature is less than or greater than 40 °C, the Ir protection pick-up is slightly modified.

To obtain the tripping time for a given temperature:

- see the tripping curves for 40 °C (see pages D-2 and D-3)
- determine tripping times corresponding to the Ir value (thermal setting on the device), corrected for the ambient temperature as indicated in the tables below.

Settings of CVS100 to 630 equipped with TM-D or TM-G* trip units as a function of the temperature

The table indicates the real Ir (A) value for a given rating and temperature.

Rat. (A)	Temperature (°C)												
	10	15	20	25	30	35	40	45	50	55	60	65	70
16	18.4	18	18	18	17	16.6	16	15.6	15.2	14.8	14.5	14	13.8
25	28.8	28	27.5	27	26.3	25.6	25	24.5	24	23.5	23	22	21
32	36.8	36	35.2	34.4	33.6	32.8	32	31.3	30.5	30	29.5	29	28.5
40	46	45	44	43	42	41	40	39	38	37	36	35	33.5
50	57.5	56	55	54	53	51	50	49	47	46	44	43	41
63	73	72	70	68	67	65	63	61	59	57	55	53	50
80	92	90	88	86	84	82	80	78	75.5	73	70.7	68	65
100	114	112	110	107	105	102.5	100	97	95	92.0	89	86	83
125	144	141	138	134	131	128	125	122	119	116	113	109	106
160	184	180	176	172	168	164	160	156	152	148	144	140	136
200	230	225	220	215	210	205	200	195	190	185	180	175	170
250	288	281	277	269	263	256	250	244	238	231	225	219	213
320	365	358	350.5	343	335.6	328	320	312	303.6	295	286	277	267.7
400	456.6	447.7	438.6	429	419.7	410	400	390	379.3	368.5	357.3	345.8	334
500	558.6	549	539.7	530	520.3	510.2	500	489.6	479	468	457	445.4	433.6
600	672	660.5	649	637	625	612.6	600	587	574	560.6	547	532.7	518

* For TM-G, the rating is from 80A to 250A.

CVS400 and 630 (equipped with ETS2.3 electronic trip unit)

The table below indicates the maximum long-time (LT) protection setting I_r (A) depending on the ambient temperature.

Type of device	Rating (A)	Temperature (°C)						
		40	45	50	55	60	65	70
CVS400								
Fixed	400	400	400	400	390	380	370	360
CVS630								
Fixed	630	630	615	600	585	570	550	535

Additional derating coefficient for an add-on module

For fixed circuit breakers equipped with a Vigi module, the coefficients in the table below must be applied.

Circuit breaker	Trip unit	Coefficient
CVS400	TMD320	0.98
	TMD400	0.94
	ETS2.3	0.97
CVS630	TMD500	0.9
	TMD600	0.89
	ETS2.3	0.9

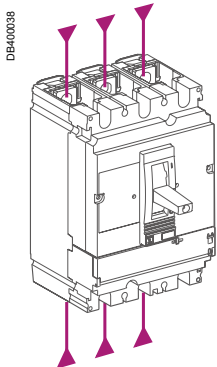

Power supply from the top or bottom

CVS circuit breakers can be supplied from either the top or the bottom, even when equipped with a Vigi earth-leakage protection module, without any reduction in performance. This capability facilitates connection when installed in a switchboard. All connection and insulation accessories can be used on circuit breakers supplied either from the top or bottom.

Weight

The table below presents the weights (in kg) of the circuit breakers and Vigi module.

Type of device	Circuit breakers			Vigi module
	CVS with TM-D	CVS with TM-G	CVS with ETS	
CVS100	3P 3D	1.64	-	0.87
	4P 4D	2.01	-	1.13
	4P 3D	2.01	-	1.13
CVS160	3P 3D	1.60	1.60	0.87
	4P 4D	2.08	-	1.13
	4P 3D	2.08	2.08	1.13
CVS250	3P 3D	1.79	1.79	0.87
	4P 4D	2.39	-	1.13
	4P 3D	2.39	2.39	1.13
CVS400	3P 3D	4.37	-	4.71
	4P 4D	5.83	-	6.32
	4P 3D	5.83	-	6.32
CVS630	3P 3D	4.80	-	5.24
	4P 4D	6.40	-	7.14
	4P 3D	6.40	-	7.14

Installation in switchboards

Safety clearances and minimum distances

General rules

When installing a circuit breaker, minimum distances (safety clearances) must be maintained between the device and panels, bars and other protection devices installed nearby. These distances, which depend on the ultimate breaking capacity, are defined by tests carried out in accordance with standard IEC 60947-2.

If installation conformity is not checked by type tests, it is also necessary to:





- use insulated bars for circuit-breaker connections
- segregate the busbars using insulating screens.

For CVS100 to 630 devices, terminal shields and interphase barriers are recommended and may be mandatory depending on the operating voltage of the device and type of installation (fixed, withdrawable, etc.).

Power connections

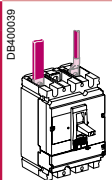
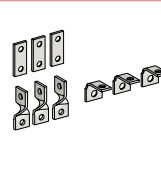
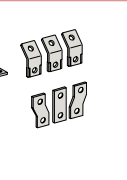
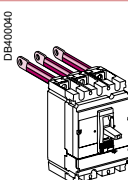
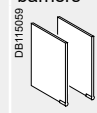
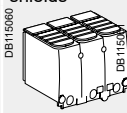
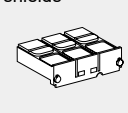
The table below indicates the rules to be respected for CVS100 to 630 devices to ensure the insulation of live parts for fixed devices.

CVS100 to 630: rules to be respected to ensure the insulation of live parts

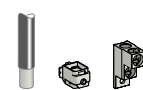
Type of connection	Fixed, front connection			Fixed, rear connection		
						
Possible, recommended or mandatory accessories:	No insulating accessory	Interphase barriers	Long terminal shields ⁽¹⁾	Short terminal shields		
With:						
operating voltage	type of conductor					
≤ 440 V	Insulated bars		Possible	Possible	Possible	Recommended
	Extension terminals		No	Mandatory (supplied)	Possible (instead of ph. barriers)	Recommended
	Cables + crimp lugs		No	Mandatory (supplied)	Possible (instead of ph. barriers)	Recommended
	Bare cables + connectors		Possible for CVS100 to 250	Possible for CVS100 to 250	Possible for CVS100 to 250	Recommended
			No	Mandatory (supplied)	Possible (instead of ph. barriers)	Recommended

⁽¹⁾ Long terminal shields provide a degree of protection of IP40 (ingress) and IK07 (mechanical impact).

Safety clearance

Minimum distance between two adjacent circuit breakers

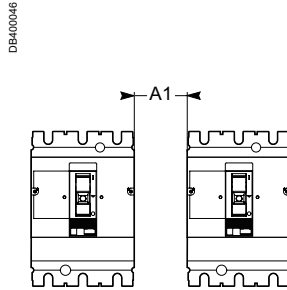

Minimum distance between circuit breaker and front or rear panels

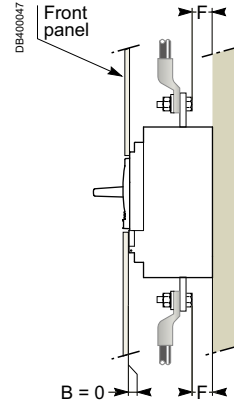

Bare or painted sheet metal **Note:** if $F < 8\text{ mm}$: an insulating screen or long terminal shield is mandatory.

Minimum distance between circuit breaker and top, bottom or side panels

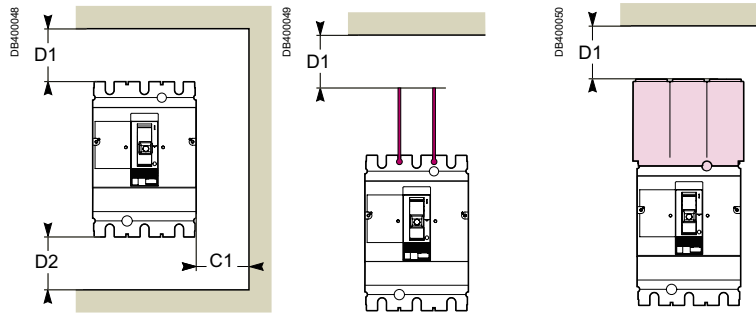

Devices without accessories. Devices with interphase barriers or long terminal shields.

Minimum safety clearances for CVS100 to 630

Dimensions (mm) circuit breaker	Insulation, insulated bars or painted sheet metal			Bare sheet metal			
	C1	D1	D2	C1	D1	D2	A1
CVS100-250 U ≤ 440V	0	30	30	5	35	35	0
CVS400-630 U ≤ 440V	0	30	30	5	60	60	0

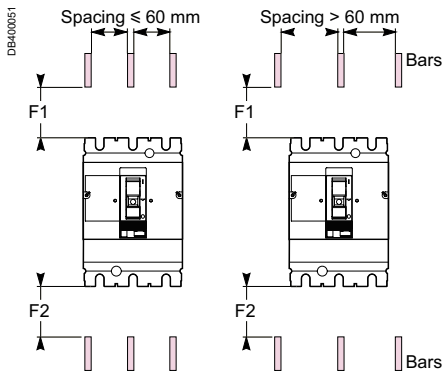

Live busbars.

Clearances with respect to live bare busbars

Minimum clearances for CVS100 to 630

Operating voltage	Clearances with respect to live bare busbars			
	spacing $\leq 60 \text{ mm}$		spacing $> 60 \text{ mm}$	
	F1	F2	F1	F2
$U < 440 \text{ V}$	350	350	80	80
$U = 440 \text{ V}$	350	350	120	120

These clearances can be reduced for special installations as long as the configuration is checked by tests.

EasyPact CVS thermal power loss values are used to calculate total temperature rise in the switchboard in which the circuit breakers are installed.

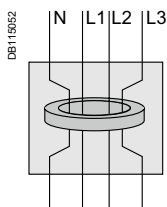

With a Vigi module, the deviation of the N and L3 bars required to pass through the toroid results in higher power losses compared to those of the L1 and L2 bars.

The values indicated in the tables below are typical values for a device at full rated load and 50/60 Hz.

Power loss per pole (P/pole) in Watts (W)

The value indicated is the power loss at I_{N^*} 50/60 Hz, for a three-pole or four-pole circuit breaker. Measurement and calculation of power loss are carried out in compliance with the recommendations of Annex G of standard IEC 60947-2.

Resistance per pole (R/pole) in milliohms (mΩ)

The value of the resistance per pole is provided as a general indication for a new device.

The value of the contact resistance must be determined on the basis of the measured voltage drop, in accordance with the manufacturer's test procedure (ABT

instruction document no. 1 - BEE - 02.2 -A).

Note: this measurement is not sufficient to determine the quality of the contacts, i.e. the capacity of the circuit breaker to carry its rated current.

Additional power loss

Additional power loss is equal to the sum of the power dissipated by the following:

- Vigi module: note that the deviation of the N and L3 bars required to pass through the toroid results in higher power losses compared to those of the L1 and L2 bars (diagram opposite). When calculating total power loss, use L1, L2, L3 for a 3P device and N, L1, L2, L3 for a 4P device
- disconnecting contacts (plug-in and withdrawable devices)
- ammeter module
- transformer module.

Calculation of total power loss

Total power loss at full rated load and 50/60 Hz is equal to the sum of the device and additional power losses per pole multiplied by the number of poles (2, 3 or 4).

If a Vigi module is installed, it is necessary to differentiate between N and L3 on one hand and L1 and L2 on the other.

EasyPact CVS100 to 630 equipped with TM-D trip units

Type of device 3/4 poles	Fixed device			Additional power/pole	
	Rat. (A)	R/pole	P/pole	Vigi (N,L3)	Vigi (L1,L2)
CVS100	16	11.91	3.05	0	0
	25	6.91	4.32	0	0
	32	4.43	4.54	0.06	0.03
	40	4.125	6.60	0.1	0.05
	50	3.30	8.25	0.15	0.08
	63	1.92	7.62	0.3	0.15
	80	1.86	11.90	0.4	0.2
CVS160	100	1.37	13.70	0.7	0.35
	100	0.77	7.70	0.7	0.35
	125	0.69	10.78	1.1	0.55
CVS250	160	0.55	14.08	1.8	0.9
	160	0.46	11.78	1.8	0.9
	200	0.39	15.60	2.8	1.4
CVS400	250	0.3	18.75	4.4	2.2
	320	0.24	24.00	2.05	1.03
CVS630	400 ⁽¹⁾	0.19	30.00	2.86	1.43
	500 ⁽²⁾	0.17	40.80	4.08	2.04
	600 ⁽³⁾	0.15	53.80	5.7	2.85

(1) The power loss value for Vigi module is given for 378A

(2) The power loss value for Vigi module is given for 451A

(3) The power loss value for Vigi module is given for 534A

EasyPact CVS100 to 630 equipped with MA trip units

Type of device 3/4 poles	Fixed device			Additional power/pole	
	Rat. (A)	R/pole	P/pole	Vigi (N,L3)	Vigi (L1,L2)
CVS100	2.5	148.91	0.93	0	0
	6.3	99.51	3.95	0	0
	12.5	4.54	0.71	0	0
	25	2.15	1.34	0	0
	50	1.16	2.90	0.2	0.1
	100	0.52	5.20	0.7	0.35
CVS160	150	0.38	8.55	1.35	0.68
CVS250	220	0.3	14.52	2.9	1.45
CVS400	320	0.15	15.40	3.2	1.6
CVS630	500	0.13	32.20	13.99	7

Power loss/ Resistance

EasyPact CVS equipped with electronic trip units

The values indicated in the table below are typical values for a device at full rated load and 50/60 Hz. The definitions and information are the same as that for circuit breakers equipped with thermal-magnetic trip units.

CVS400 to 630 equipped with electronic trip units

Type of device 3/4 poles	Fixed device			Additional power/pole	
	Rat. (A)	R/pole	P/pole	Vigi (N,L3)	Vigi (L1,L2)
CVS400	400	0.15	24.00	3.2	1.6
CVS630	630 ⁽⁴⁾	0.12	47.63	6.5	3.25

⁽⁴⁾ The power loss value for Vigi module is given for 570A

Dimensions and connection



Dimensions and connection

<i>Functions and characteristics</i>	A-1
<i>Installation recommendations</i>	B-1
Dimensions and mounting	C-2
EasyPact CVS100 to 630	C-2
Vigi CVS100 to 630	C-3
Direct rotary handle for EasyPact and Vigi CVS100 to 630	C-4
Extended rotary handle for EasyPact CVS100 to 630	C-5
Front-panel accessories	C-6
EasyPact CVS100 to 630	C-6
Front-panel cutouts	C-7
EasyPact CVS100 to 630	C-7
Vigi CVS100 to 630	C-8
Direct rotary handle for EasyPact and Vigi CVS100 to 630	C-9
Power connections	C-11
EasyPact and Vigi CVS100 to 630	C-11
Connection of insulated bars or cables with lugs to EasyPact and Vigi CVS100 to 630	C-14
Connection of bare cables to EasyPact and Vigi CVS100 to 630	C-15
<i>Additional characteristics</i>	D-1
<i>Catalogue numbers</i>	E-1
<i>EasyPact CVS100BS</i>	F-1

Dimensions

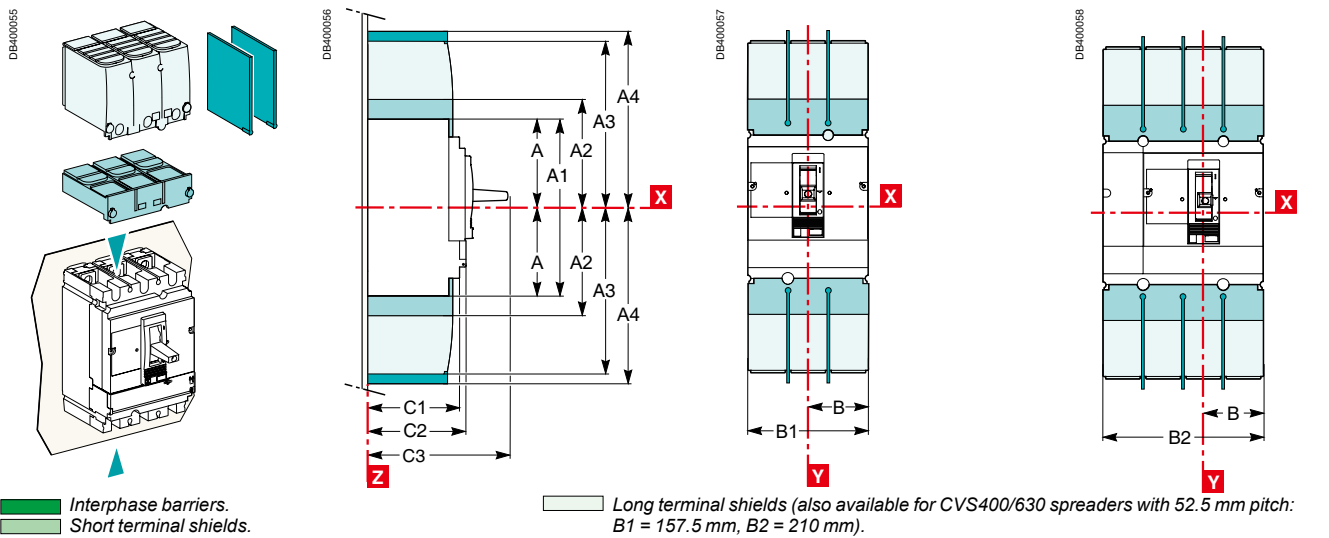

Mounting

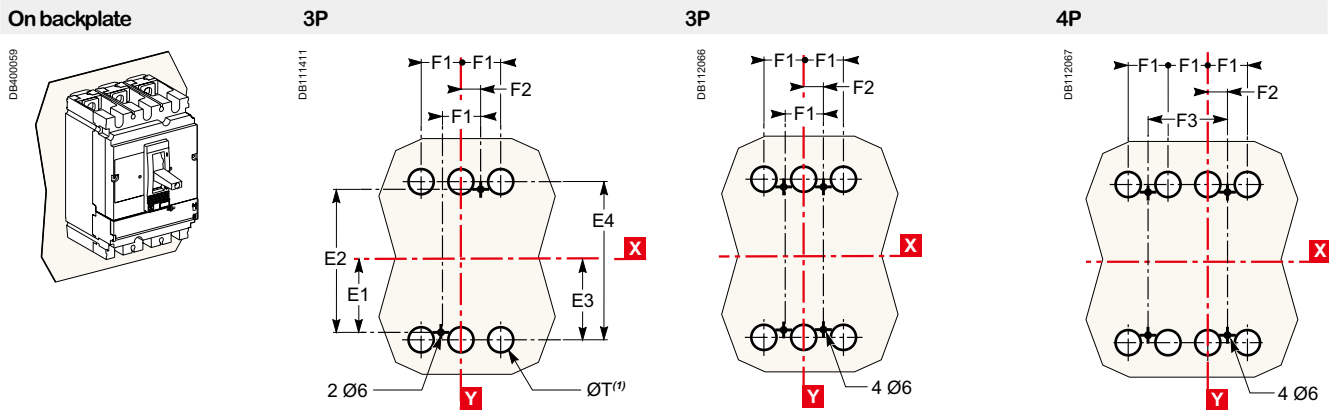

(1) The ØT holes are required for rear connection only.

On rails

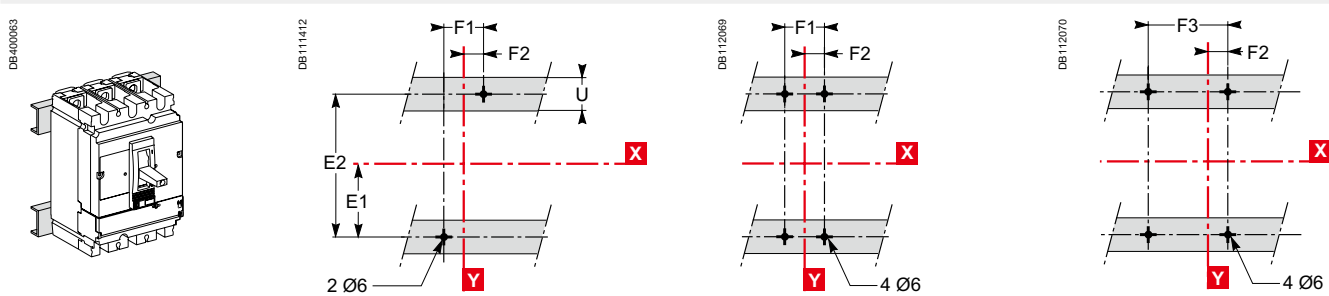

On DIN rail with adaptor plate (CVS100 to 250)

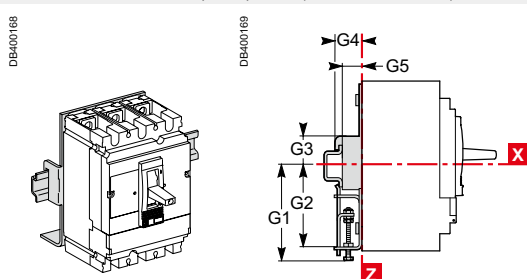

Dimensions

3/4P

3/4P

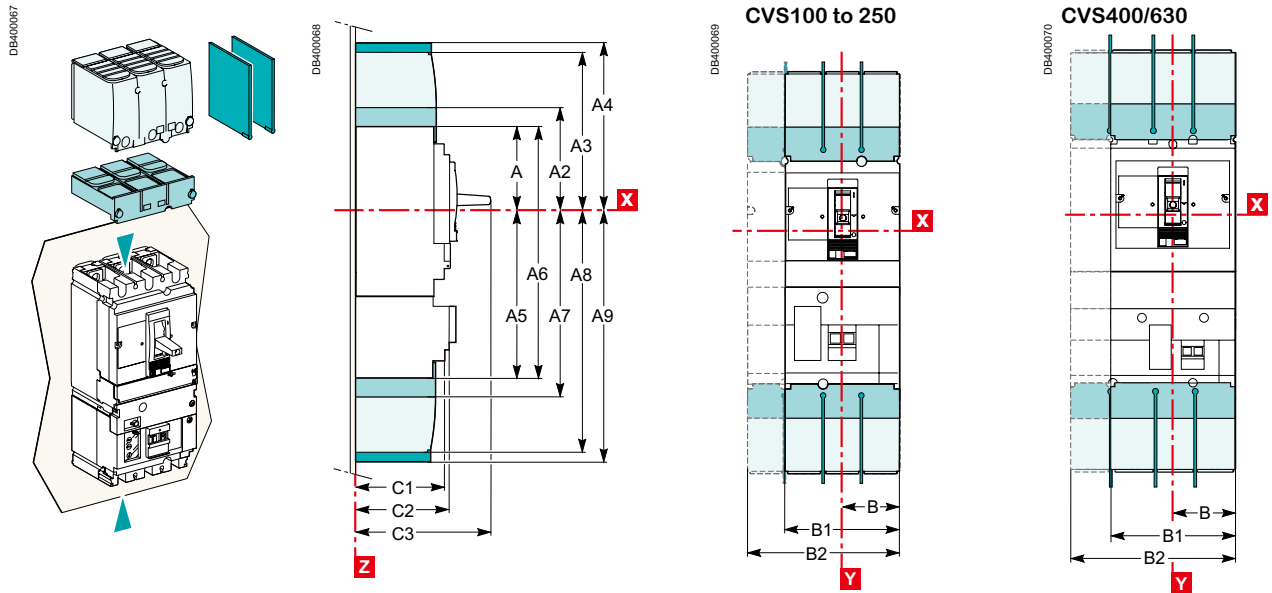

Mounting

CVS100 to 250

CVS400/630

CVS100 to 630

On backplate

3P

3P

4P

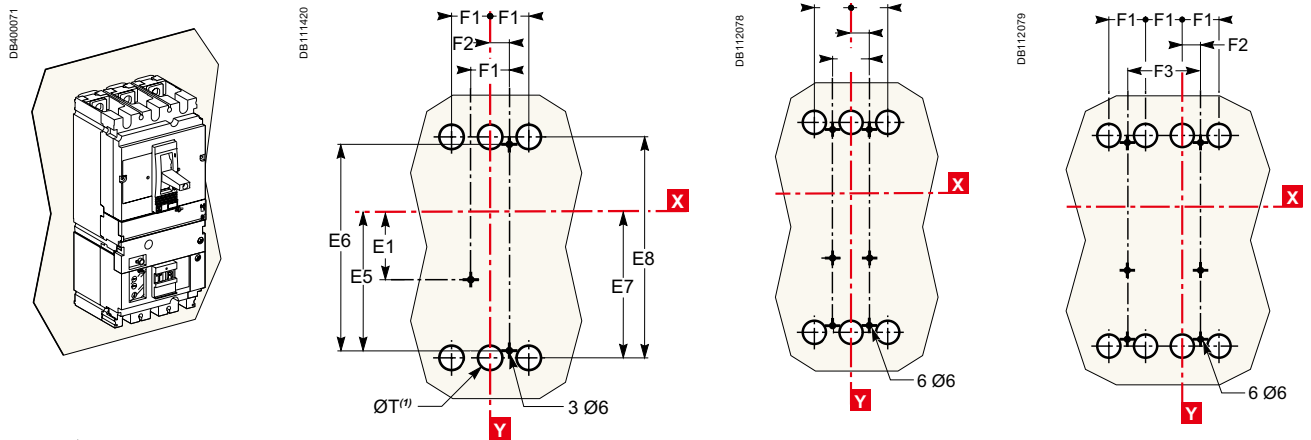

(1) The ØT holes are required for rear connection only.

On rails

3P

3P

4P

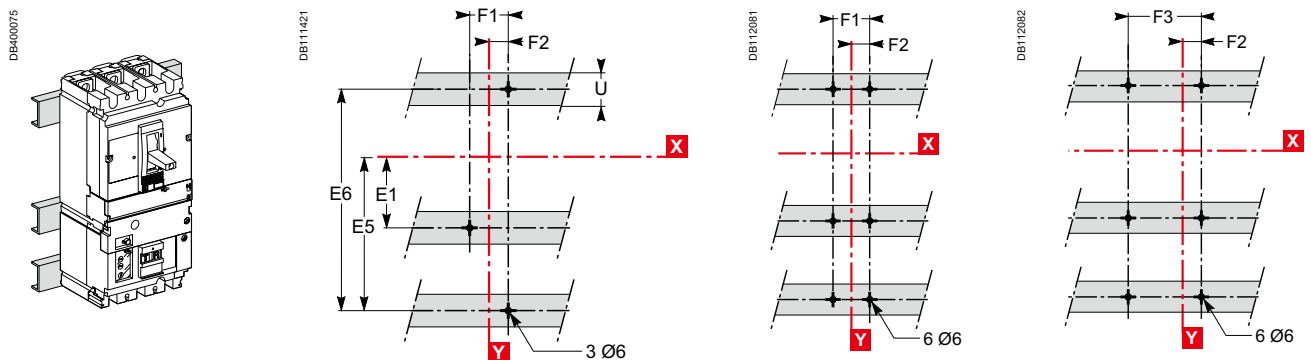

Type	A	A1	A2	A3	A4	A5	A6	A7	A8	A9	B	B1	B2	C1	C2	C3	E1
CVS100/160/250	80.5	161	94	145	178.5	155.5	236	169	220	253.5	52.5	105	140	81	86	111 ⁽²⁾	62.5
CVS400/630	127.5	255	142.5	200	237	227.5	355	242.5	300	337	70	140	185	95.5	110	168	100
Type	E2	E3	E4	E5	E6	E7	E8	F1	F2	F3	G1	G2	G3	G4	G5	ØT	U
CVS100/160/250	125	70	140	137.5	200	145	215	35	17.5	70	95	75	13.5	23	17.5	24	≤32
CVS400/630	200	113.5	227	200	300	213.5	327	45	22.5	90	-	-	-	-	-	32	≤35

(2) C3=126mm for EasyPact CVS250B/F.

Dimensions

3P

4P

Fixed circuit breaker

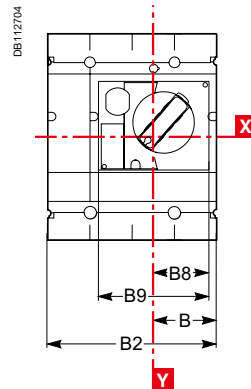
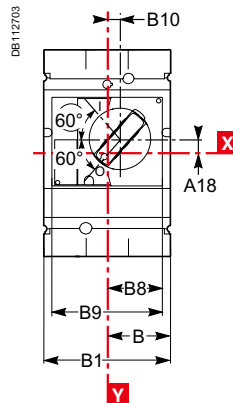
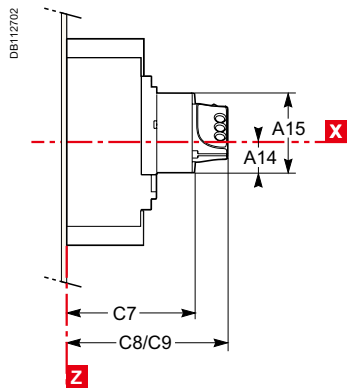
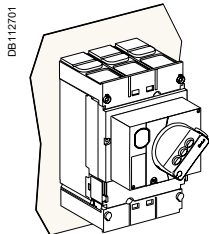

C8: without keylock
C9: with keylock

Type	A14	A15	A18	B8	B9	B10	C7	C8	C9
CVS100/160/250	27.5	73	9	45.5	91	9.25	121	155	164
CVS400/630	40	123	24.6	61.5	123	5	145	179	188

Dimensions

Fixed circuit breakers

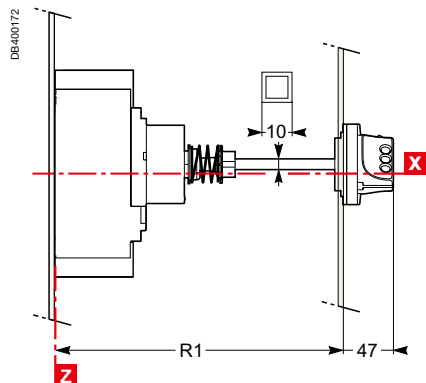
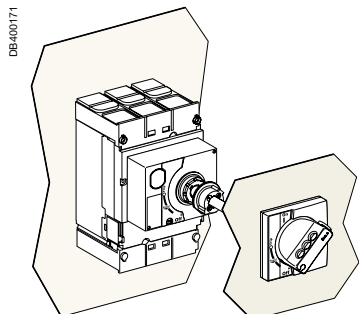

Cutout for shaft (mm)

Type	R1
CVS100/160/250	min. 171 max. 600
CVS400/630	min. 195 max. 600

Dimensions and front-panel cutout

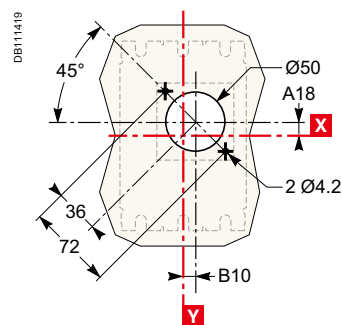
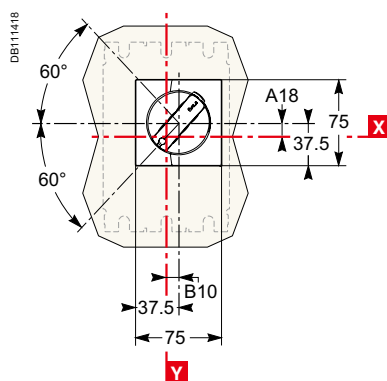

Type	A18	B10
CVS100/160/250	9	9.25
CVS400/630	24.6	5

IP40 front-panel escutcheons

For toggle

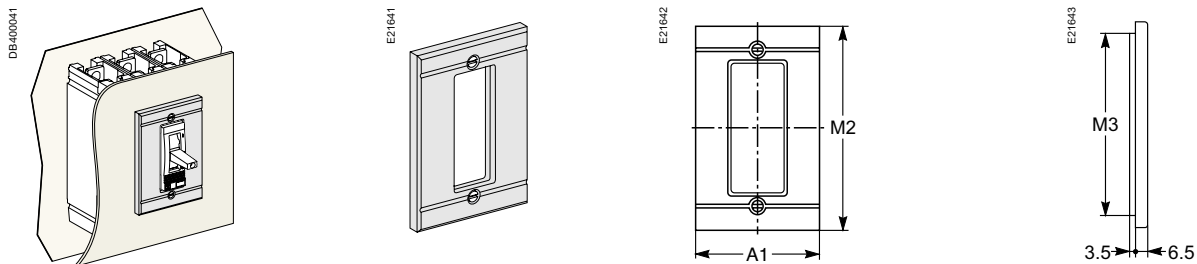

For rotary handle or module and protection collar

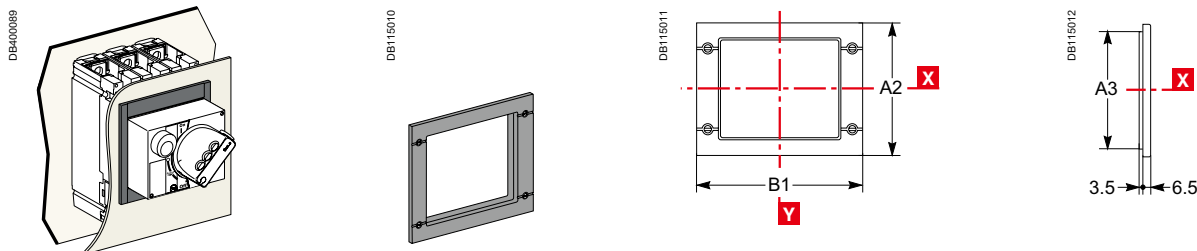

For Vigi

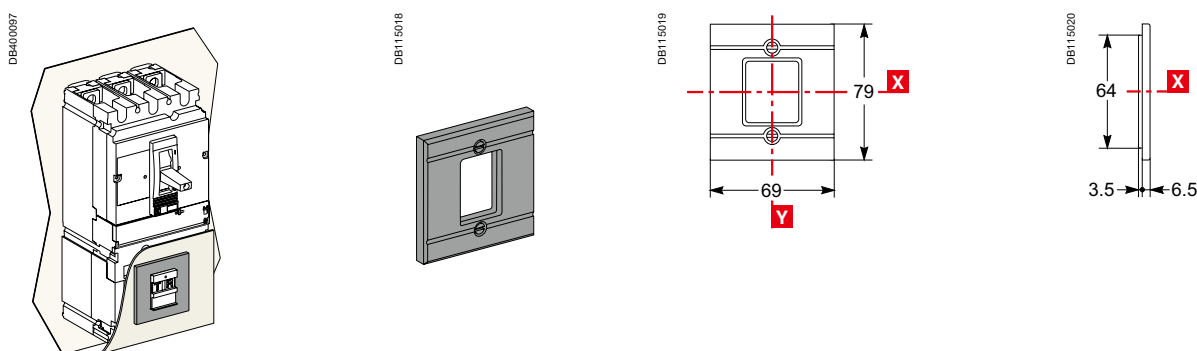

Type	A1	A2	A3	B1	M2	M3
CVS100/160/250	91	114	101	157	115	102
CVS400/630	123	164	151	189	155	142

Bare sheet metal

CVS100 to 250

CVS400/630

For toggle

DB400034

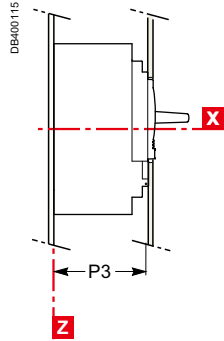
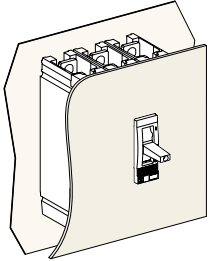

DB400116

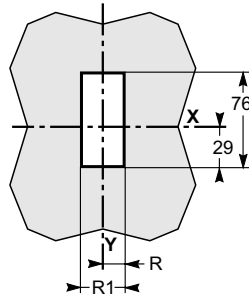

DB400117

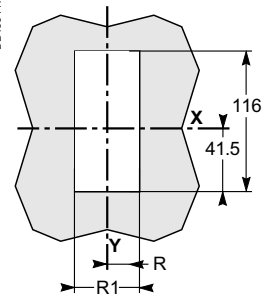

For toggle with access to trip unit

DB400118

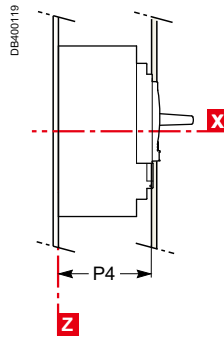
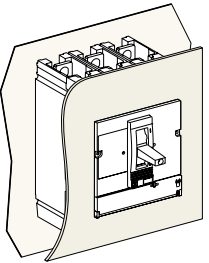

DB400120

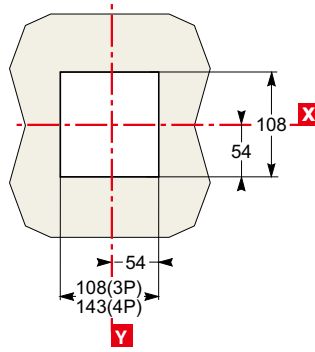

DB400121

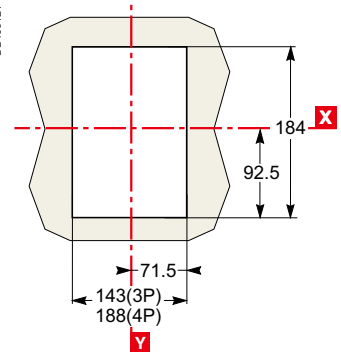

Type	P3	P4	R	R1
CVS100/160/250	88	83	14.5	29
CVS400/630	112	107	31.5	63

Bare sheet metal

CVS100 to 250

CVS400/630

For toggle

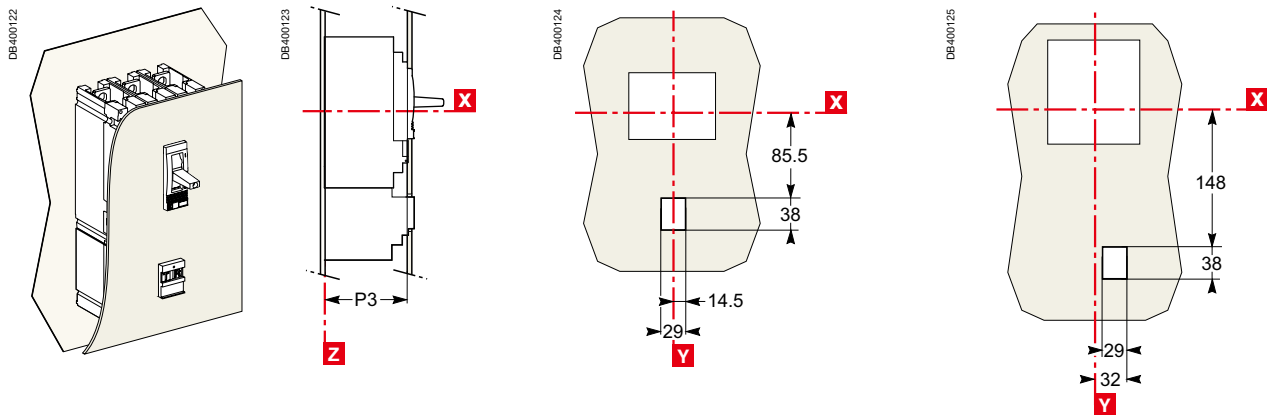

For toggle with access to trip unit

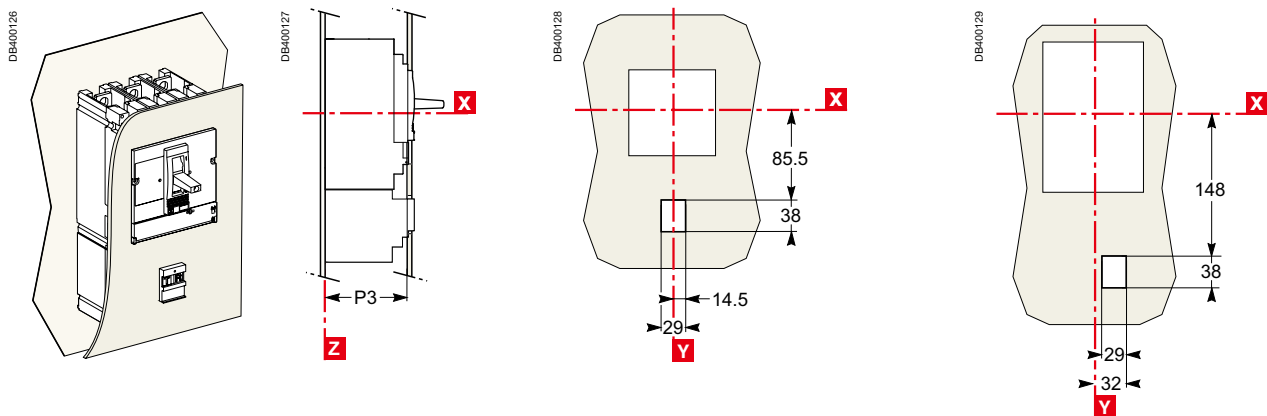

Front-panel cutouts

Direct rotary handle for EasyPact and Vigi CVS100 to 630

Fixed circuit breakers

CVS100 to 250

CVS400/630

Bare sheet metal

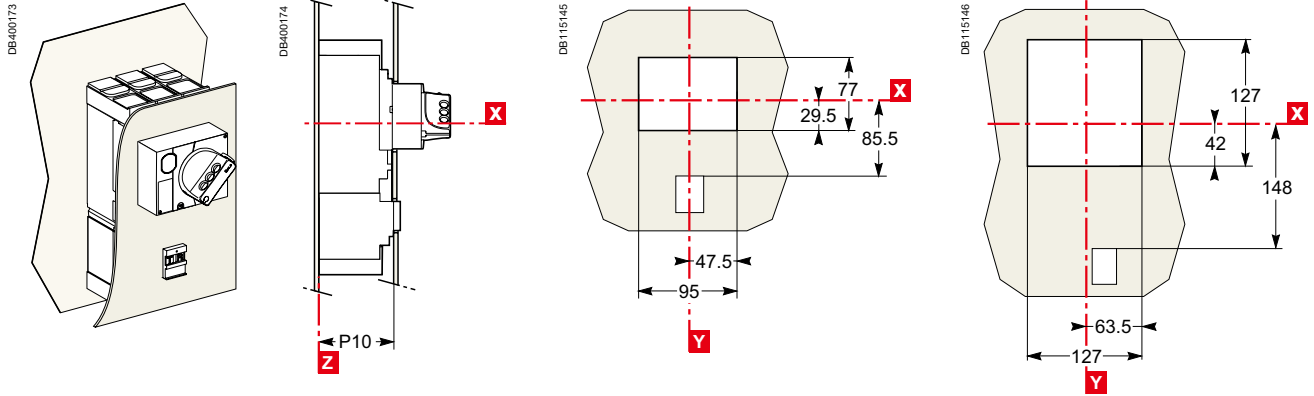

Bare sheet metal with access to the trip unit

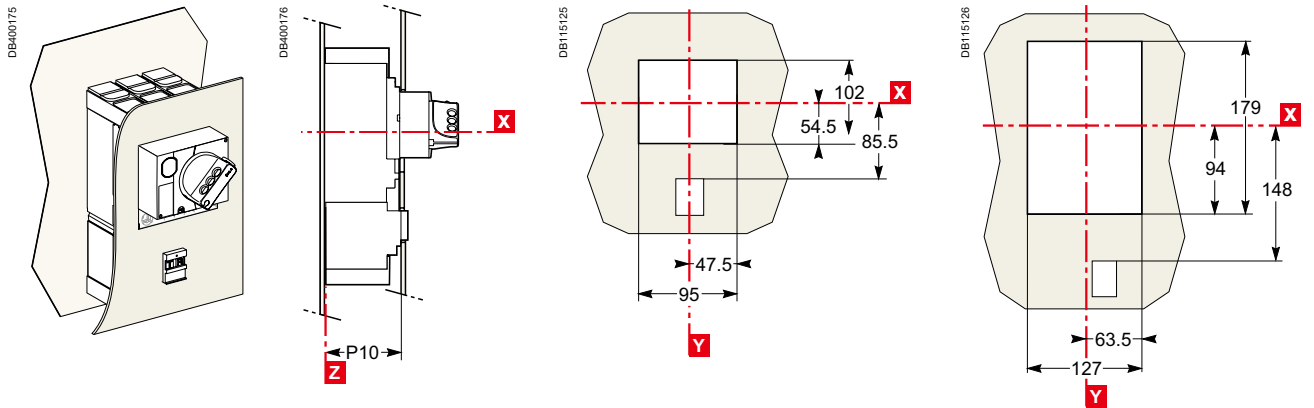

With IP30 front-panel escutcheon

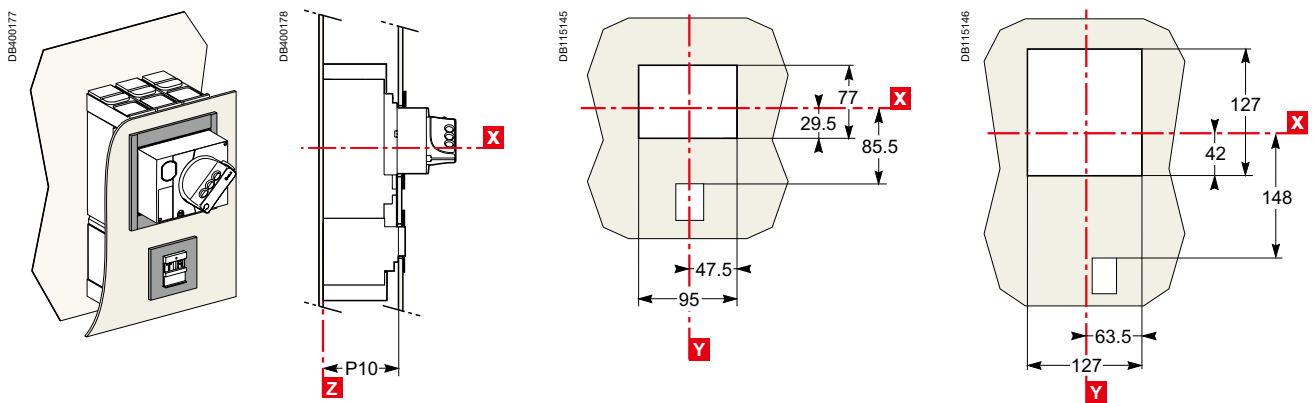

Front-panel cutouts Direct rotary handle for EasyPact and Vigi CVS100 to 630

Fixed circuit breakers (cont.)

CVS100 to 250

CVS400/630

With IP30 front-panel escutcheon with access to the trip unit

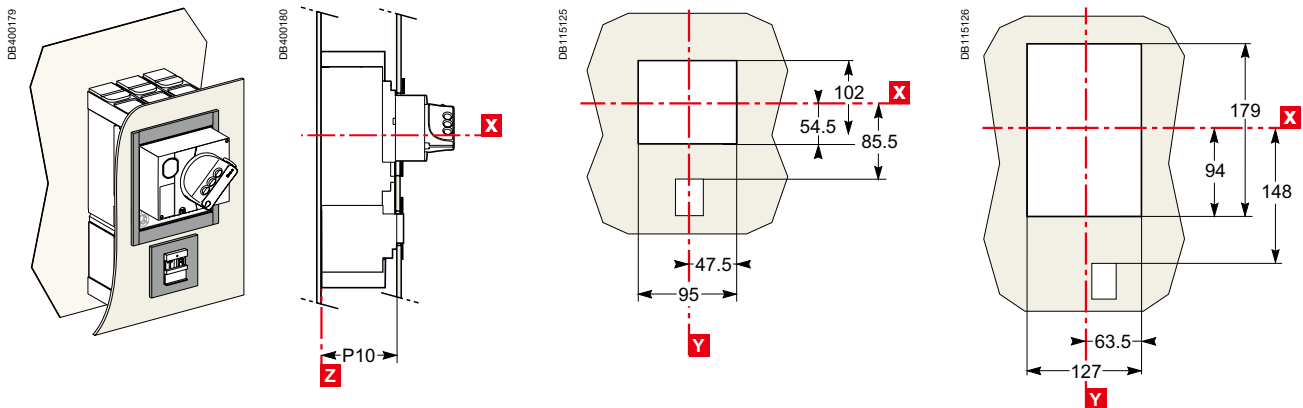

With IP40 front-panel escutcheon

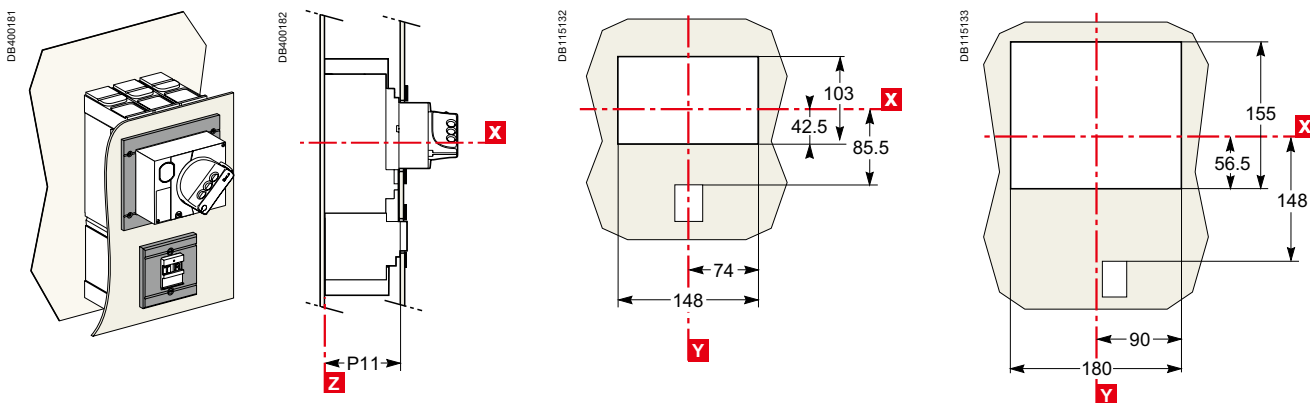

Type	P10	P11	P12
CVS100/160/250	89	90	123
CVS400/630	112	113	147

Connection locations

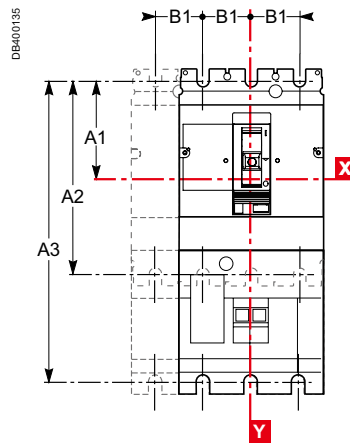
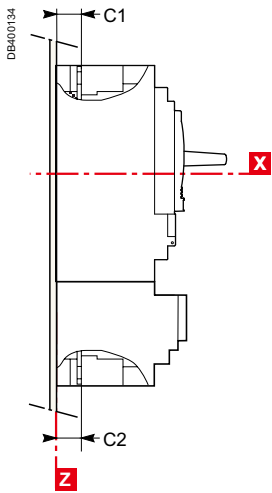

Type	A1	A2	B1	C1	C2
CVS100/160	70	140	35	19.5	19.5
CVS250	70	140	35	21.5	19.5
CVS400/630	113.5	227	45	26	26

Type	A1	A3	B1	C1	C2
CVS100/160 + Vigi	70	215	35	19.5	21.5
CVS250 + Vigi	70	215	35	21.5	21.5
CVS400/630 + Vigi	113.5	327	45	26	26

Front connection without accessories

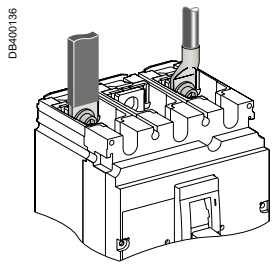

CVS100 to 250

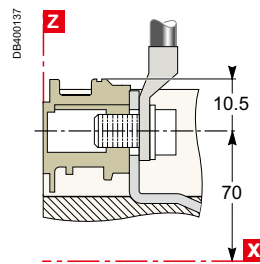

Cables with lugs/bars

CVS400/630

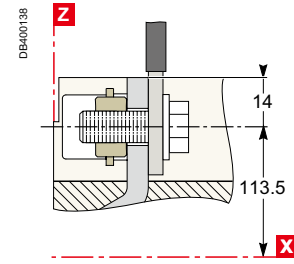

Bars/cables with lugs

Connection with accessories

Long and short rear connectors

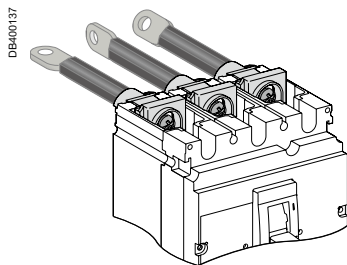

CVS100 to 250

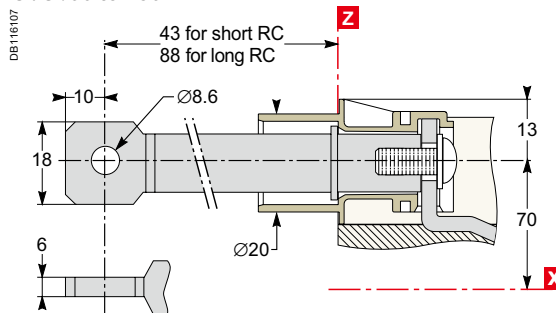

CVS400/630

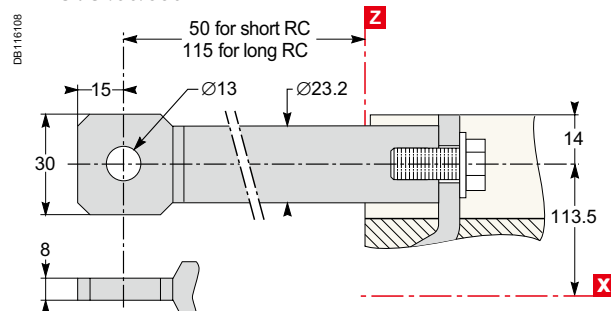

Connection with accessories (cont.)

Bare-cable connectors

DB400138

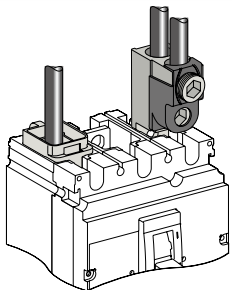

CVS100 to 250

DB115451

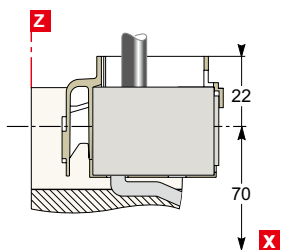

DB115452

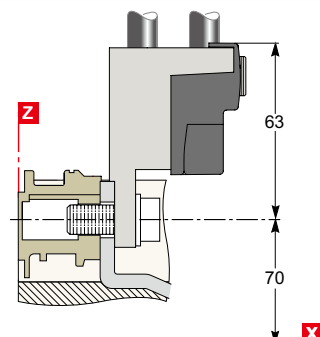

DB400139

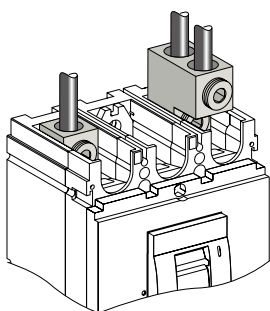

CVS400/630

DB115454

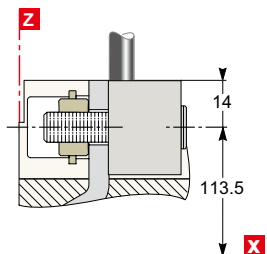

DB115455

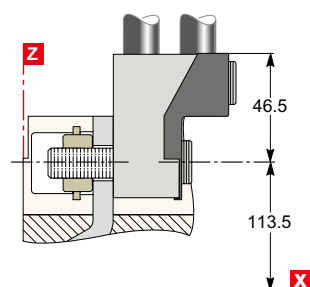

Distribution connectors (for CVS100 to 250 only)

DB115456

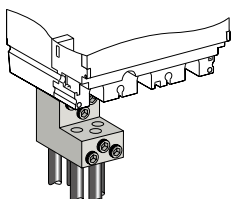

DB115457

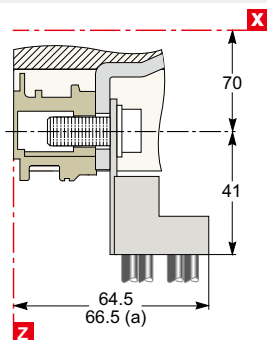

(a) Vigi module or CVS250.

Right-angle terminal extensions (upstream only)

DB400140

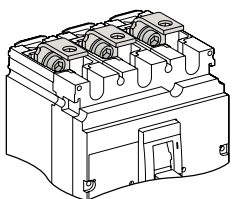

CVS100 to 250

DB115459

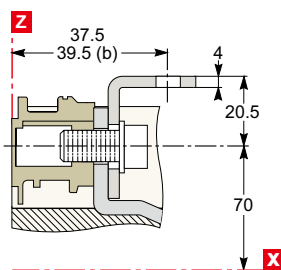

(b) CVS250.

CVS400/630

DB115460

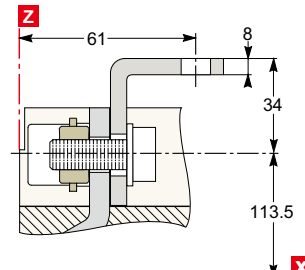

Straight terminal extensions (for CVS100 to 250 only)

DB400141

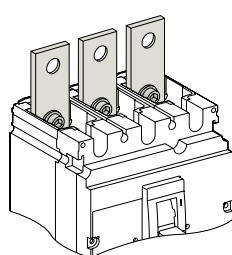

DB115462

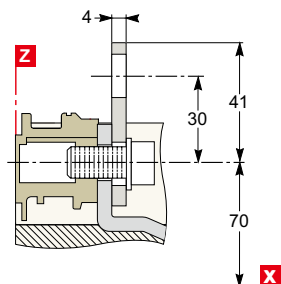

Connection with accessories (cont.)

Spreaders

3P

4P

CVS100 to 250

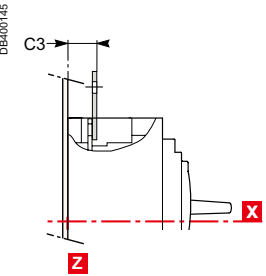

CVS400/630

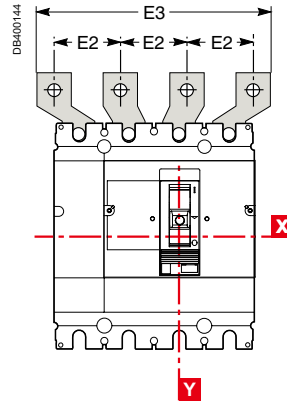
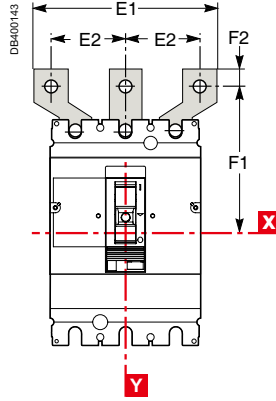
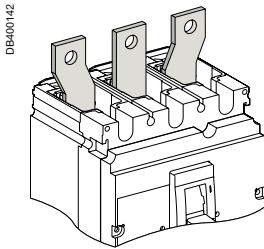
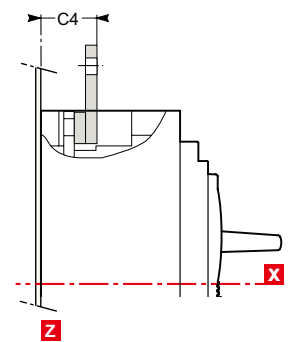

Type	C3	C4	E1	E2	E3	F1	F2
CVS100/160	23.5	-	114	45	159	100	11
CVS250	25.5	-	114	45	159	100	11
CVS400/630	-	44	135	52.5	187.5	152.5	15
			170	70	240	166	15

Power connections

Connection of insulated bars or cables with lugs to EasyPact and Vigi CVS100 to 630

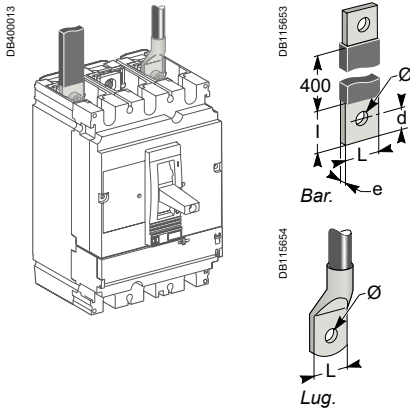

Accessories for CVS100 to 250

Straight terminal extensions

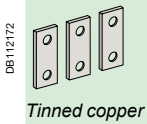

Tinned copper

Spreaders: separate parts

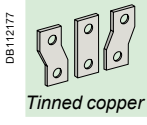

Tinned copper

Accessories for CVS400 and 630

Spreaders made up of separate parts for 52.5 and 70 mm pitch

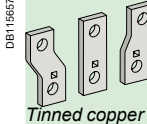

Tinned copper

Accessories for CVS100 to 630

Right-angle terminal extensions

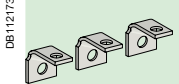

Tinned copper
To be mounted on upstream side.

Direct connection to CVS100 to 630

Dimensions		CVS100	CVS160/250	CVS400/630
Bars	L (mm)	≤ 25	≤ 25	≤ 32
	l (mm)	d + 10	d + 10	d + 15
	d (mm)	≤ 10	≤ 10	≤ 15
	e (mm)	≤ 6	≤ 6	3 ≤ e ≤ 10
	Ø (mm)	6.5	8.5	10.5
	L (mm)	≤ 25	≤ 25	≤ 32
Lugs	Ø (mm)	6.5	8.5	10.5
	Torque (Nm) ⁽¹⁾	10	15	50
Torque (Nm) ⁽²⁾		5/5	5/5	20/11

(1) Tightening torque on the circuit breaker for lugs or bars.

(2) Tightening torque on fixed devices for rear connectors.

Connection with accessories to CVS100 to 250 (IEC 228)

Pole pitch		With spreaders or terminal extensions	
Without spreaders		35 mm	
With spreaders		45 mm	
Dimensions		CVS100	CVS160/250
Bars	L (mm)	≤ 25	≤ 25
	l (mm)	20 ≤ l ≤ 25	20 ≤ l ≤ 25
	d (mm)	≤ 10	≤ 10
	e (mm)	≤ 6	≤ 6
	Ø (mm)	6.5	8.5
	L (mm)	≤ 25	≤ 25
Lugs	Ø (mm)	6.5	8.5
	Torque (Nm) ⁽¹⁾	10	15

(1) Tightening torque on the circuit breaker for spreaders or terminal extensions.

Spreaders and straight, right-angle, 45°, double-L and edgewise terminal extensions are supplied with flexible interphase barriers.

Connection with accessories to CVS400 and 630 (IEC 228)

Pole pitch		With spreaders		With terminal extensions	
Without spreaders		45 mm			
With spreaders		52.5 or 70 mm			
Dimensions		With spreaders	With terminal extensions		
Bars	L (mm)	≤ 40	≤ 32		
	l (mm)	d + 15	30 ≤ l ≤ 34		
	d (mm)	≤ 20	≤ 15		
	e (mm)	3 ≤ e ≤ 10	3 ≤ e ≤ 10		
	Ø (mm)	12.5	10.5		
	L (mm)	≤ 40	≤ 32		
Lugs	Ø (mm)	12.5	10.5		
	Torque (Nm) ⁽¹⁾	50	50		

(1) Tightening torque on the circuit breaker for spreaders or terminal extensions.

Spreaders and right-angle, 45° and edgewise terminal extensions are supplied with flexible interphase barriers.

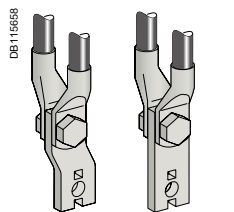

Mounting detail: 2 cables with lugs.

Power connections

Connection of bare cables to EasyPact and Vigi CVS100 to 630

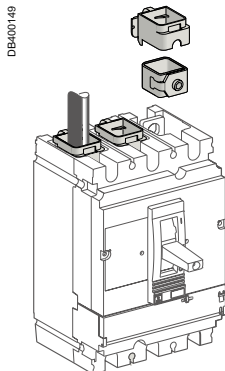

Connection for CVS100 to 250

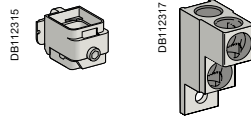

1-cable connector 2-cable connector

	1-cable connector	Steel ≤ 160 A	Aluminium ≤ 250 A	
DB115963 	L (mm)	25	25	
	S (mm ²) Cu/Al	1.5 to 95 ⁽¹⁾	25 to 50	70 to 95 120 to 185 150 max. flex.
	Torque (Nm)	12	20	26
	2-cable connector			
	L (mm)	25 or 50		
	S (mm ²) Cu/Al	2 x 50 to 2 x 120		
	Torque (Nm)	22		

(1) For flexible cables from 1.5 to 4 mm², connection with crimped or self-crimping ferrules.

Connection to CVS400 and 630



1-cable connector 2-cable connector

	1-cable connector	2-cable connector	
DB115963 	L (mm)	30	30 or 60
	S (mm ²) Cu/Al	35 to 300 rigid 240 max. flex.	2 x 35 to 2 x 240 rigid 240 max. flex.
	Torque (Nm)	31	31

Conductor materials and electrodynamic stresses

EasyPact CVS circuit breakers can be connected indifferently with bare-copper, tinned-copper and tinned-aluminium conductors (flexible or rigid bars, cables). In the event of a short-circuit, thermal and electrodynamic stresses will be exerted on the conductors. They must therefore be correctly sized and held in place by supports.

Electrical connection points on switchgear devices (switch-disconnectors, contactors, circuit breakers, etc.) should not be used for mechanical support. Any partition between upstream and downstream connections of the device must be made of non-magnetic material.

Additional characteristics



Additional characteristics

<i>Functions and characteristics</i>	A-1
<i>Installation recommendations</i>	B-1
<i>Dimensions and connection</i>	C-1

Tripping curves	D-2
EasyPact CVS100 to 630 Protection of distribution systems	D-2
EasyPact CVS100 to 250 Protection of generator systems	D-6
EasyPact CVS100 to 250 Motor protection	D-8
Current and energy limiting curves	D-9

Selectivity	D-11
--------------------	-------------

Cascading	D-20
------------------	-------------

Switch disconnecter coordination	D-22
---	-------------

<i>Catalogue numbers</i>	E-1
<i>EasyPact CVS100BS</i>	F-1

Tripping curves

EasyPact CVS100 to 630

Protection of distribution systems

TM magnetic trip units

TM16D

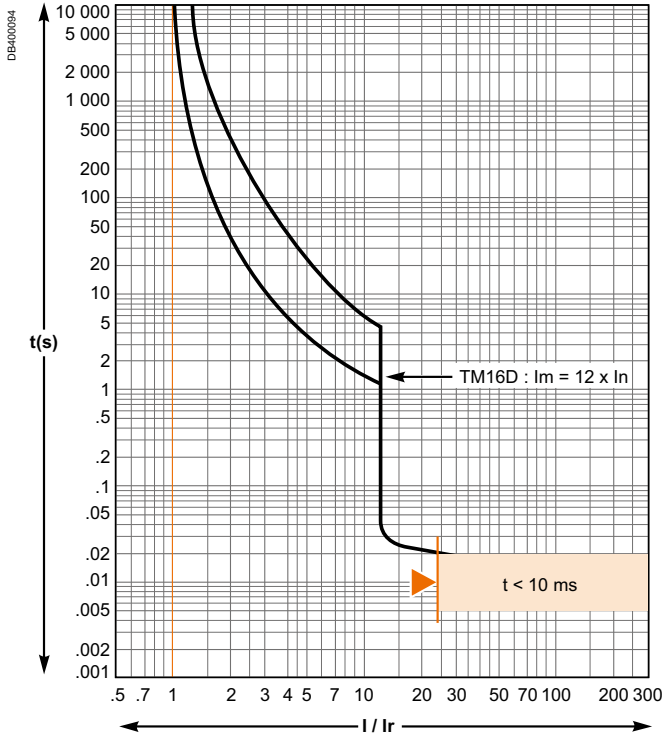

TM25D

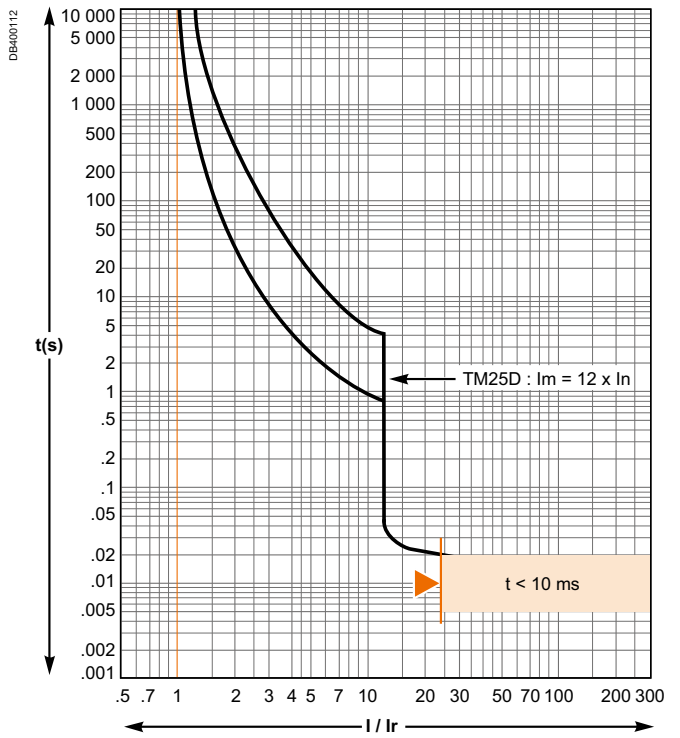

TM32D

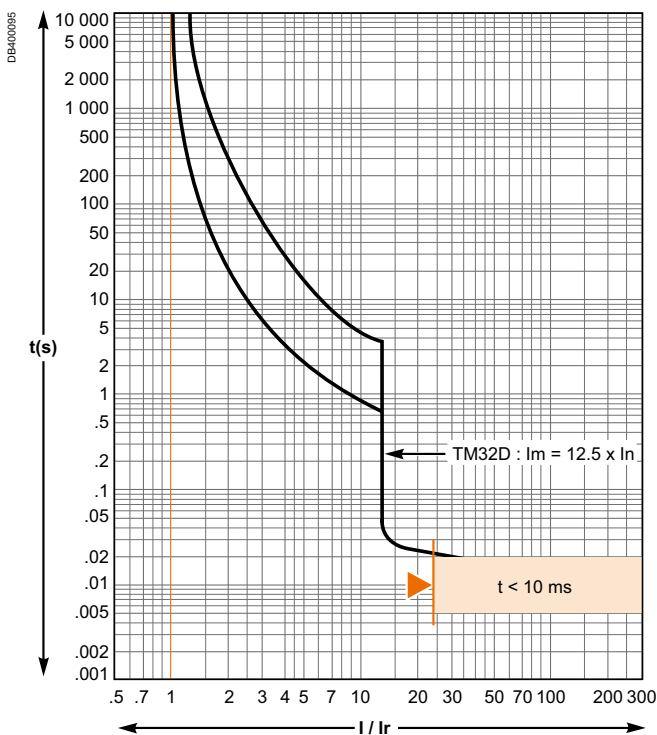

TM40D

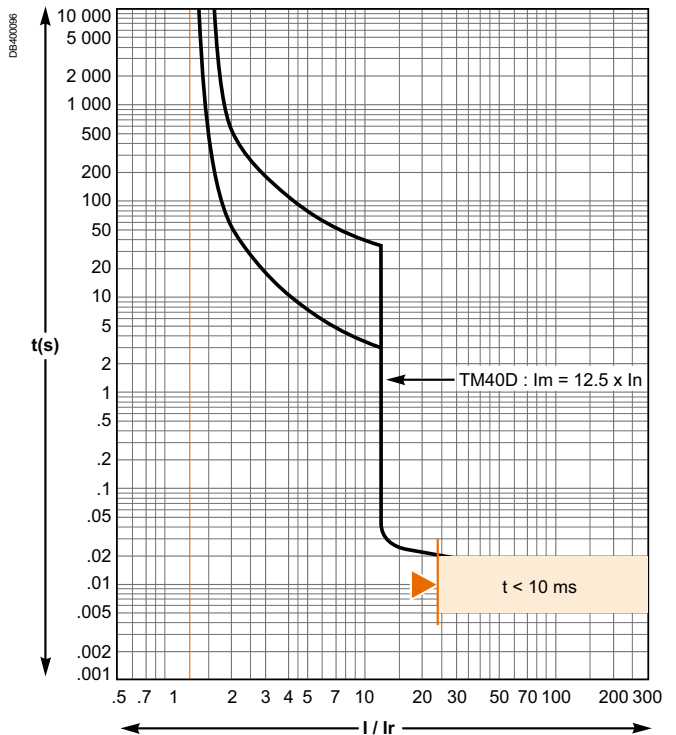

Reflex tripping.

Tripping curves

EasyPact CVS100 to 630

Protection of distribution systems

TM magnetic trip units

TM50D

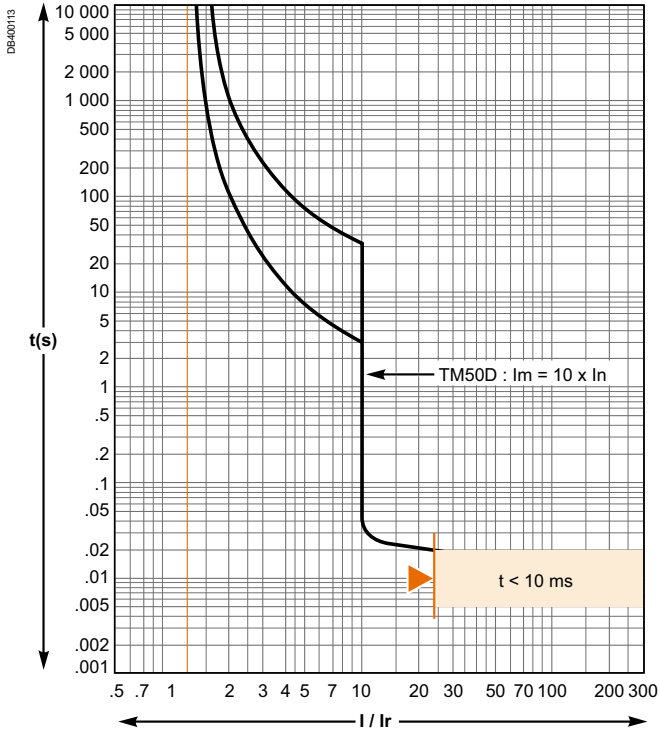

Reflex tripping.

TM63D

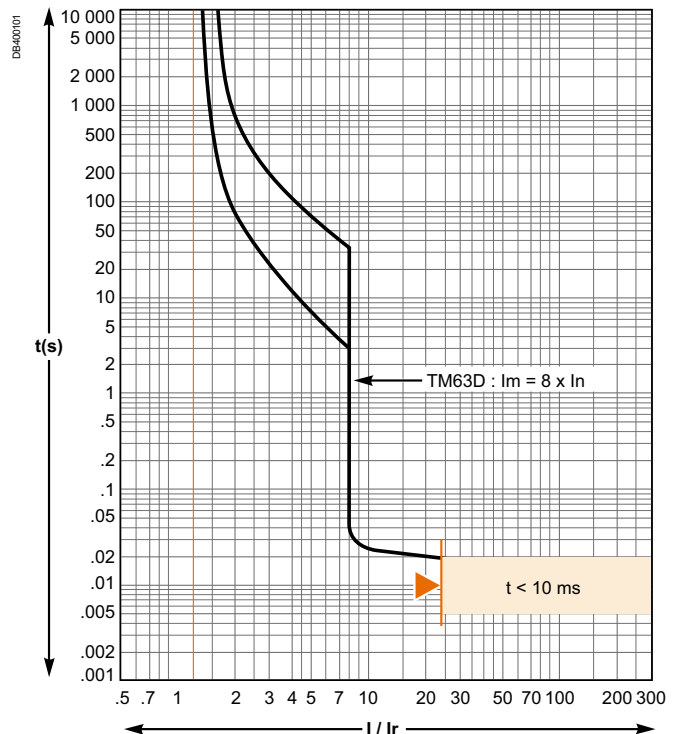

Reflex tripping.

TM80D/100D

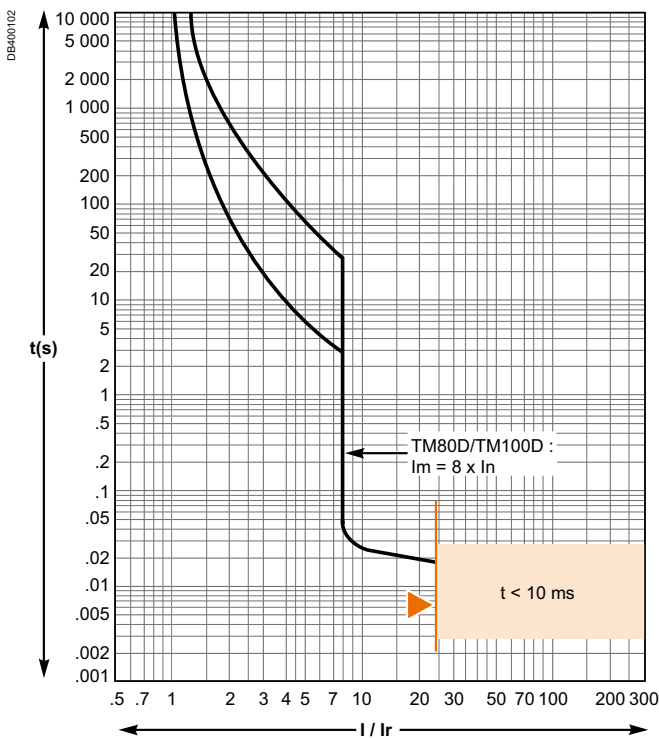

TM125D/160D

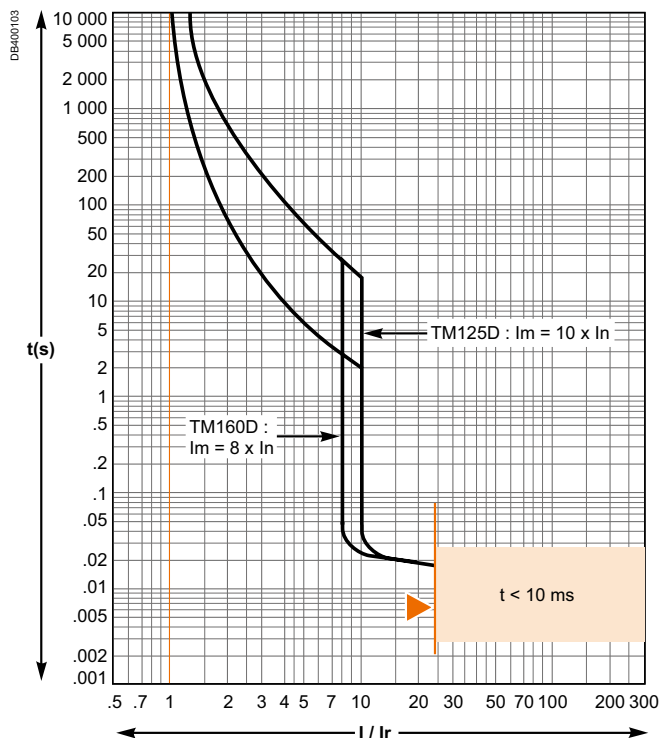

TM200D/250D

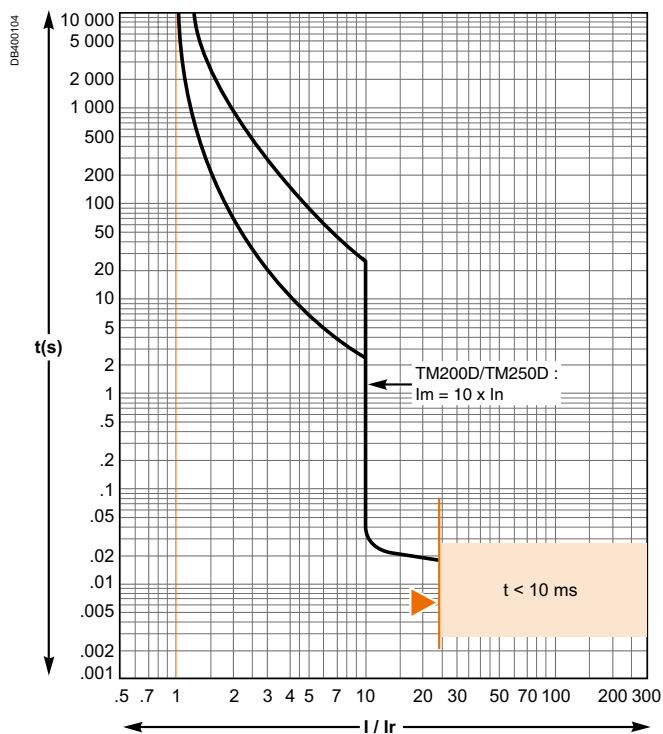

TM320D/400D

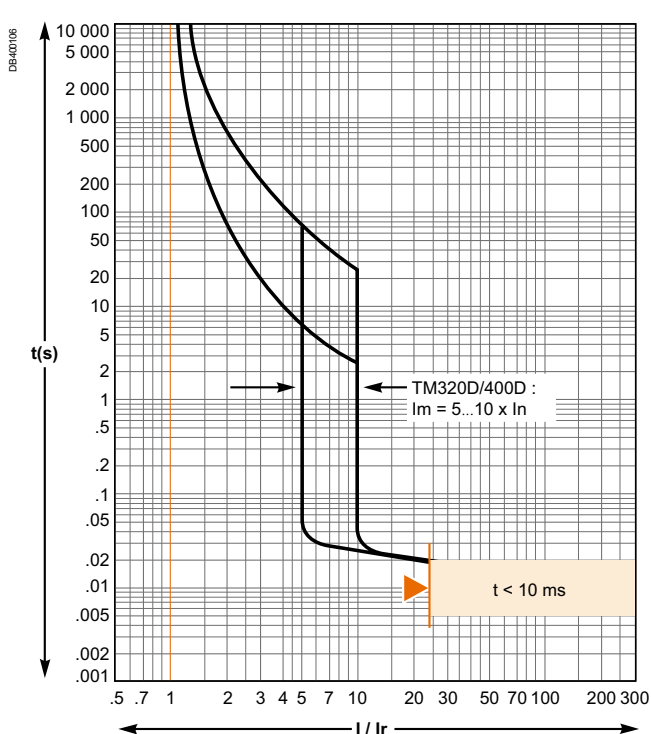

Reflex tripping.

TM500D

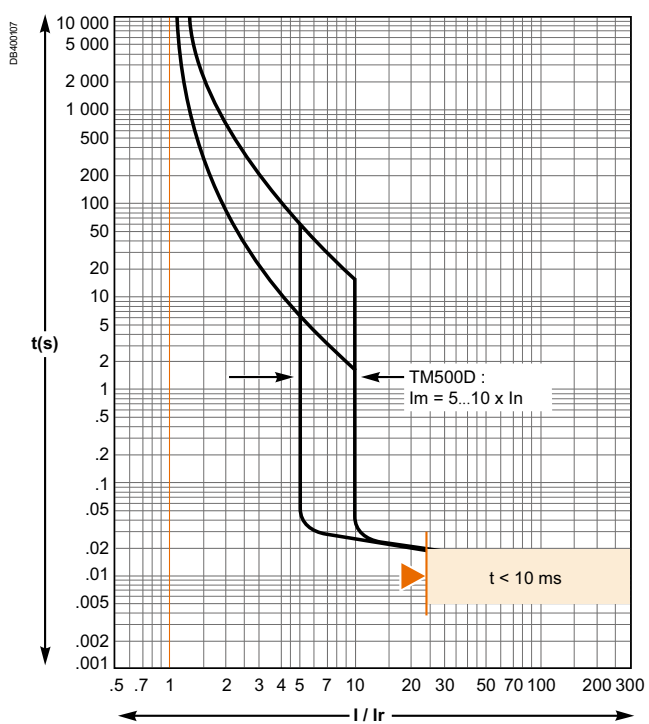

Reflex tripping.

TM600D

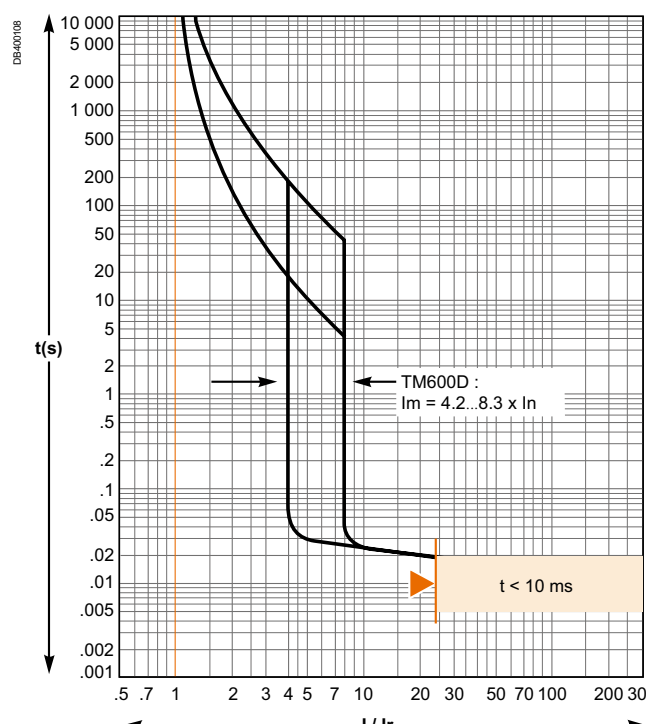

ETS2.3 electronic trip units

ETS2.3 400 A

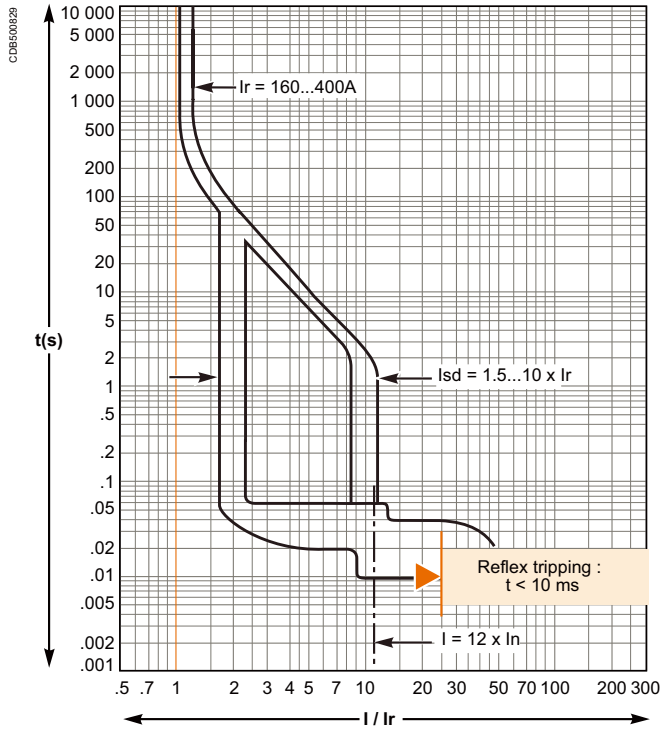

Reflex tripping.

ETS2.3 630 A

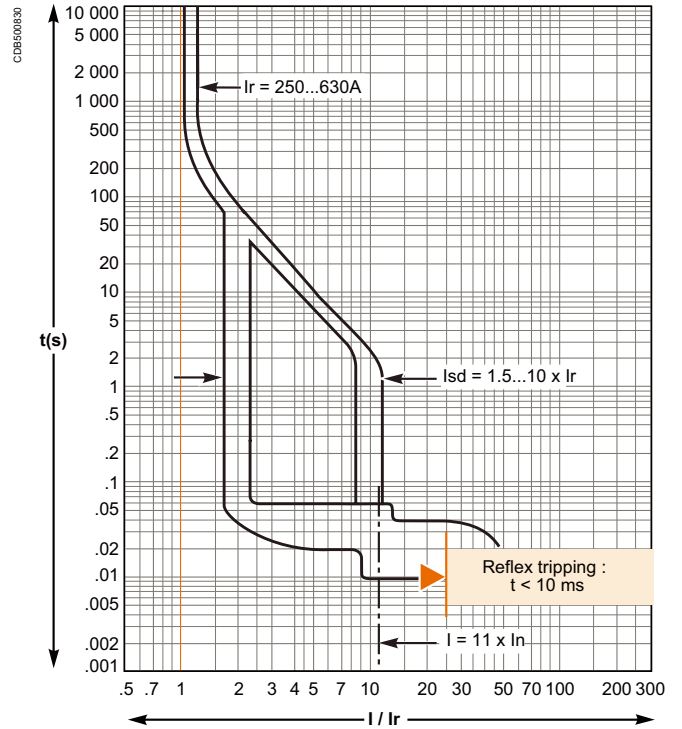

Reflex tripping.

Tripping curves

EasyPact CVS100 to 250

Protection of generator systems

TM magnetic trip units

TM80G

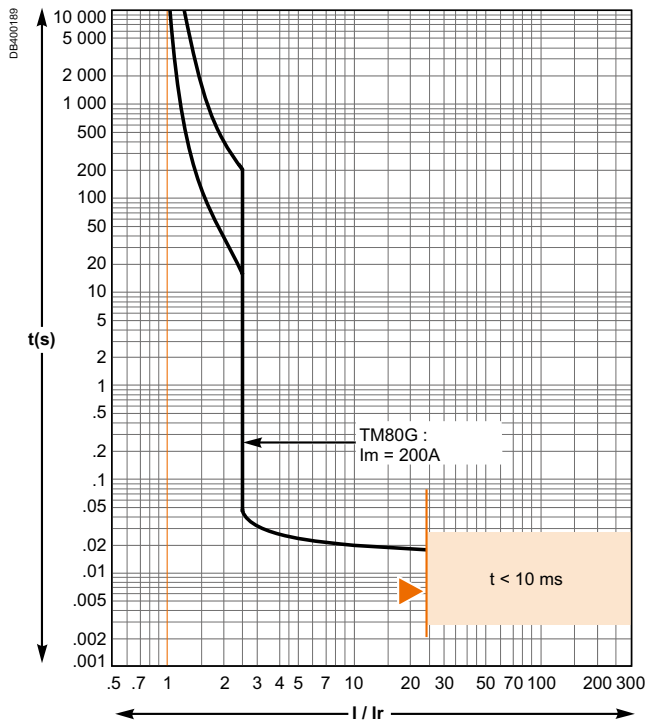

TM100G

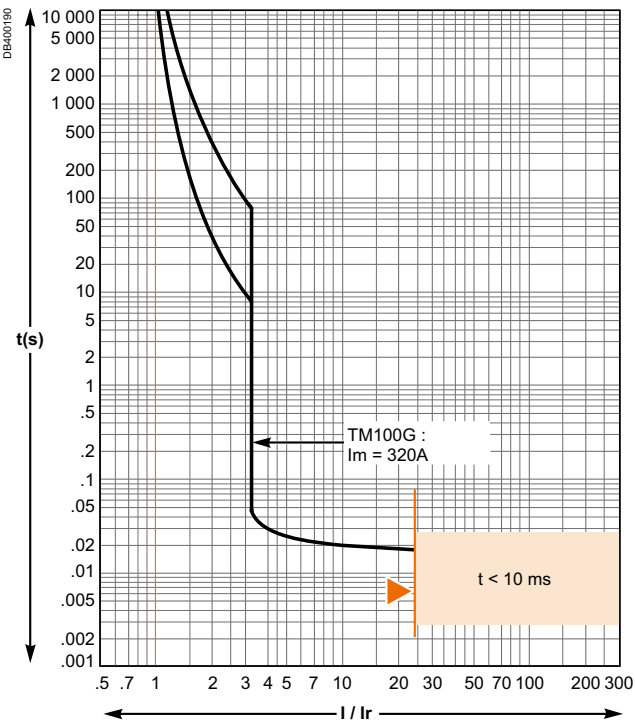

TM125G

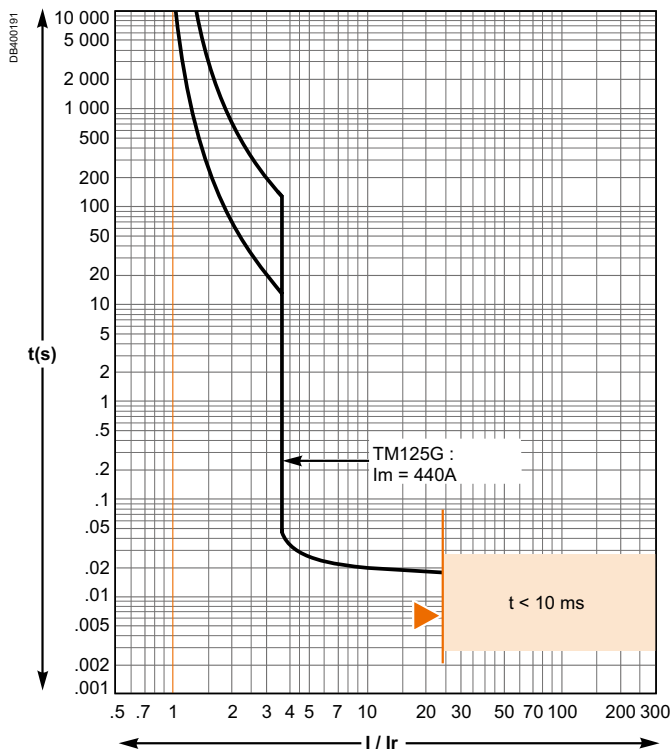

TM160G

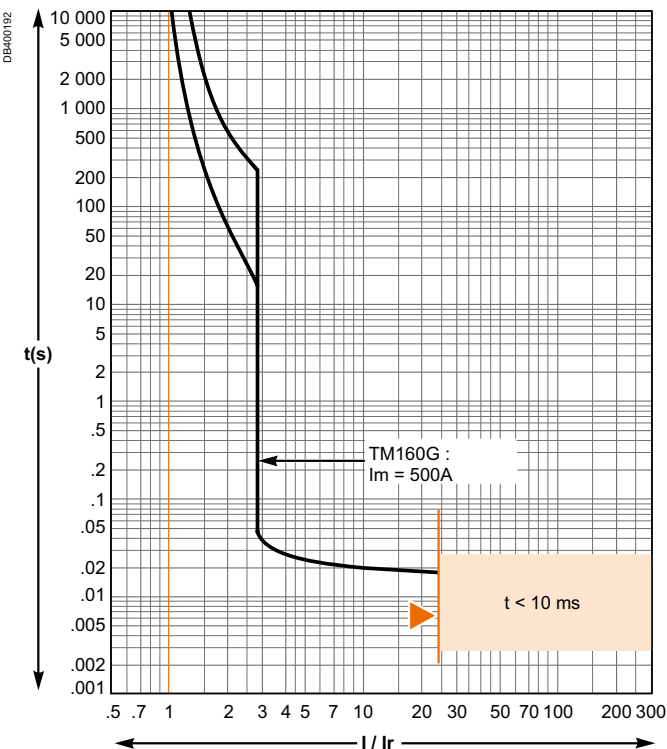

TM200G and TM250G

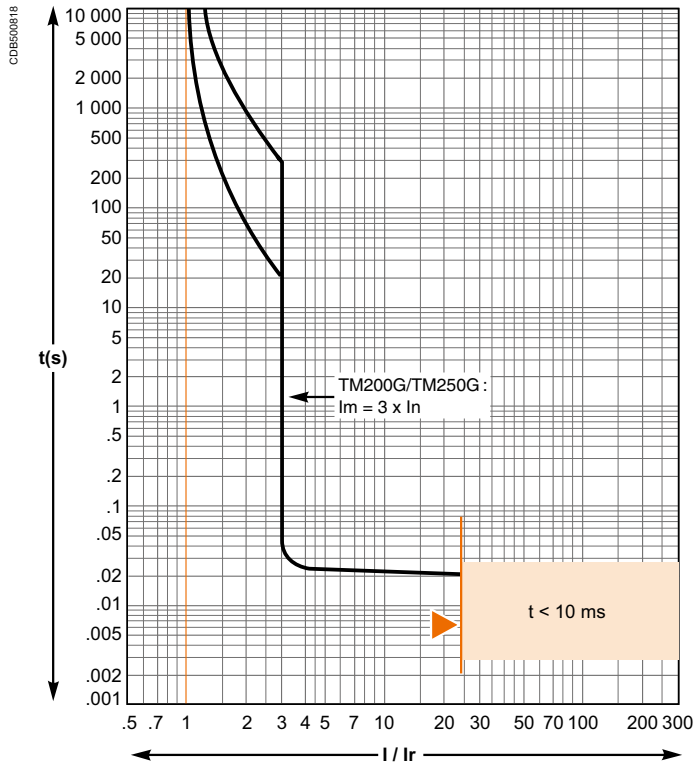

MA magnetic trip units

MA2.5... MA100

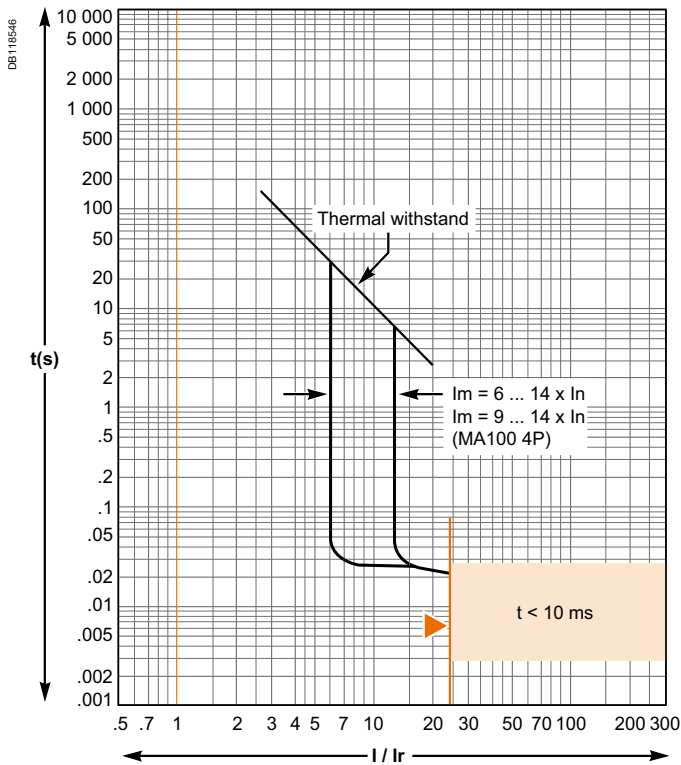

Reflex tripping.

MA150 and MA220

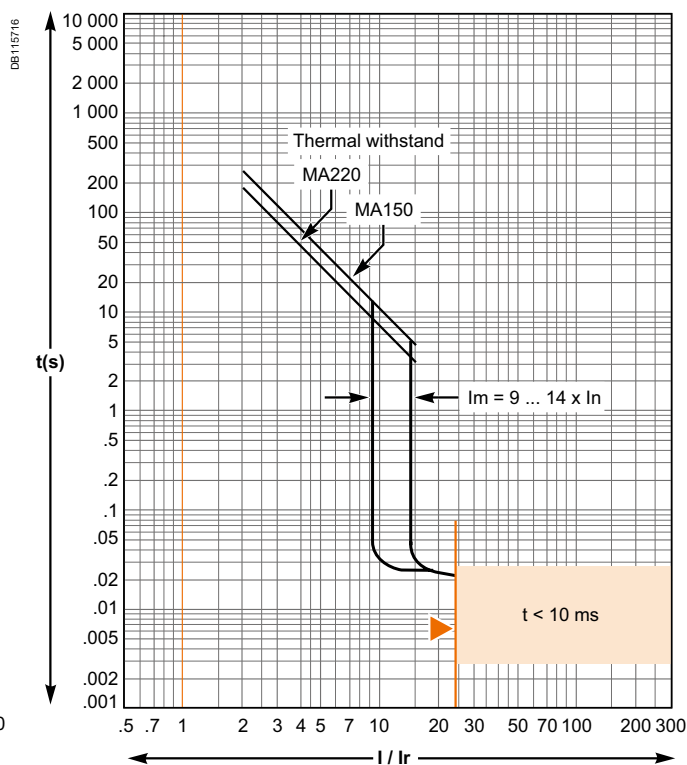

MA320

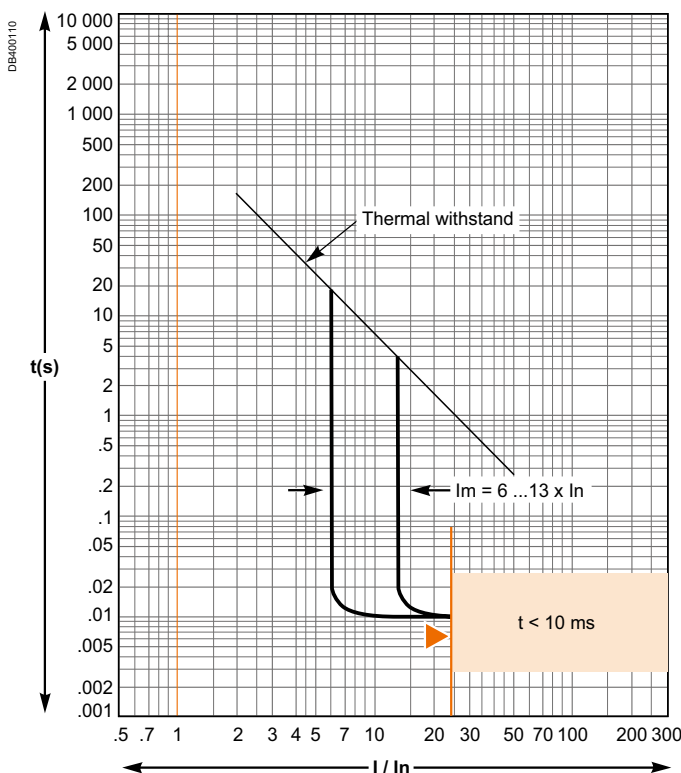

Reflex tripping.

MA500

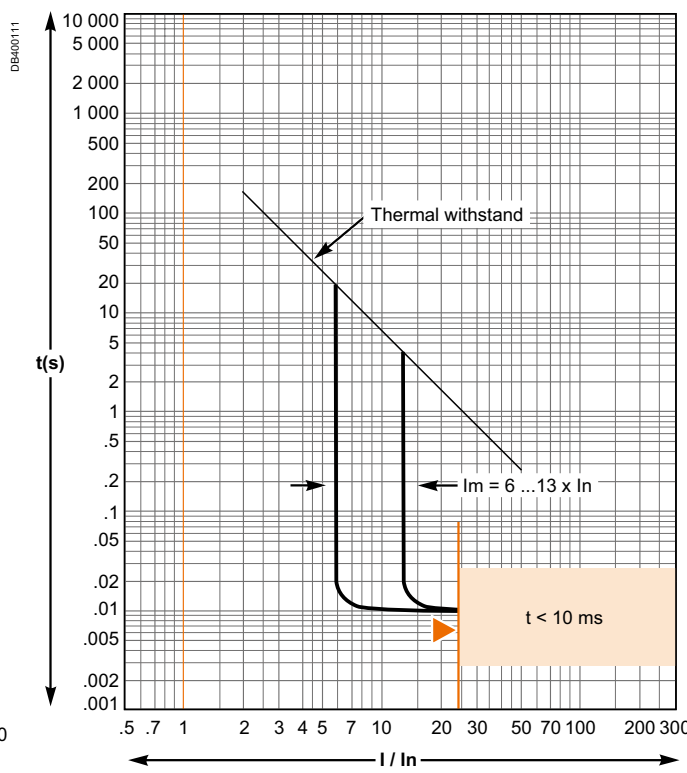

Reflex tripping.

The limiting capacity of a circuit breaker is its aptitude to let through a current, during a short-circuit, that is less than the prospective short-circuit current.

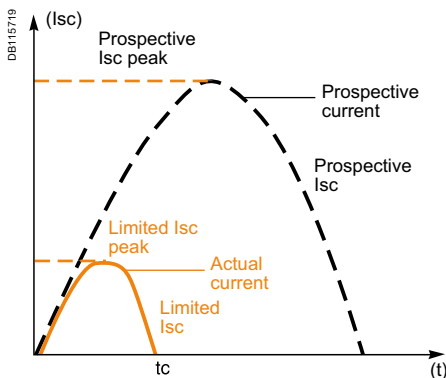

The exceptional limiting capacity of the EasyPact CVS range is due to the rotating double-break technique (very rapid natural repulsion of contacts and the appearance of two arc voltages in-series with a very steep wavefront).

Ics = 100 % Icu

The exceptional limiting capacity of the EasyPact CVS range greatly reduces the forces created by fault currents in devices.

The result is a major increase in breaking performance.

In particular, the service breaking capacity Ics is equal to 100 % of Icu.

The Ics value, defined by IEC standard 60947-2, is guaranteed by tests comprising the following steps:

- break three times consecutively a fault current equal to 100% of Icu
- check that the device continues to function normally, that is:
 - it conducts the rated current without abnormal temperature rise
 - protection functions perform within the limits specified by the standard
 - suitability for isolation is not impaired.

Longer service life of electrical installations

Current-limiting circuit breakers greatly reduce the negative effects of short-circuits on installations.

Thermal effects

Less temperature rise in conductors, therefore longer service life for cables.

Mechanical effects

Reduced electrodynamic forces, therefore less risk of electrical contacts or busbars being deformed or broken.

Electromagnetic effects

Fewer disturbances for measuring devices located near electrical circuits.

Current and energy limiting curves

The limiting capacity of a circuit breaker is expressed by two curves which are a function of the prospective short-circuit current (the current which would flow if no protection devices were installed):

- the actual peak current (limited current)
- thermal stress (A²s), i.e. the energy dissipated by the short-circuit in a conductor with a resistance of 1 Ω.

Maximum permissible cable stresses

The table below indicates the maximum permissible thermal stresses for cables depending on their insulation, conductor (Cu or Al) and their cross-sectional area (CSA). CSA values are given in mm² and thermal stresses in A²s.

CSA		1.5 mm ²	2.5 mm ²	4 mm ²	6 mm ²	10 mm ²
PVC	Cu	2.97x10 ⁴	8.26x10 ⁴	2.12x10 ⁵	4.76x10 ⁵	1.32x10 ⁶
	Al					5.41x10 ⁵
PRC	Cu	4.10x10 ⁴	1.39x10 ⁵	2.92x10 ⁵	6.56x10 ⁵	1.82x10 ⁶
	Al					7.52x10 ⁵
CSA		16 mm ²	25 mm ²	35 mm ²	50 mm ²	
PVC	Cu	3.4x10 ⁶	8.26x10 ⁶	1.62x10 ⁷	3.31x10 ⁷	
	Al	1.39x10 ⁶	3.38x10 ⁶	6.64x10 ⁶	1.35x10 ⁷	
PRC	Cu	4.69x10 ⁶	1.39x10 ⁷	2.23x10 ⁷	4.56x10 ⁷	
	Al	1.93x10 ⁶	4.70x10 ⁶	9.23x10 ⁶	1.88x10 ⁷	

Current-limiting curves

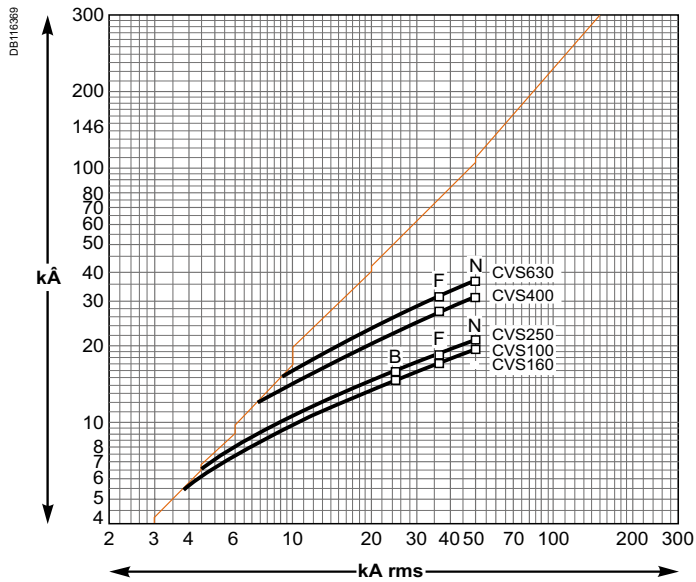

Energy-limiting curves

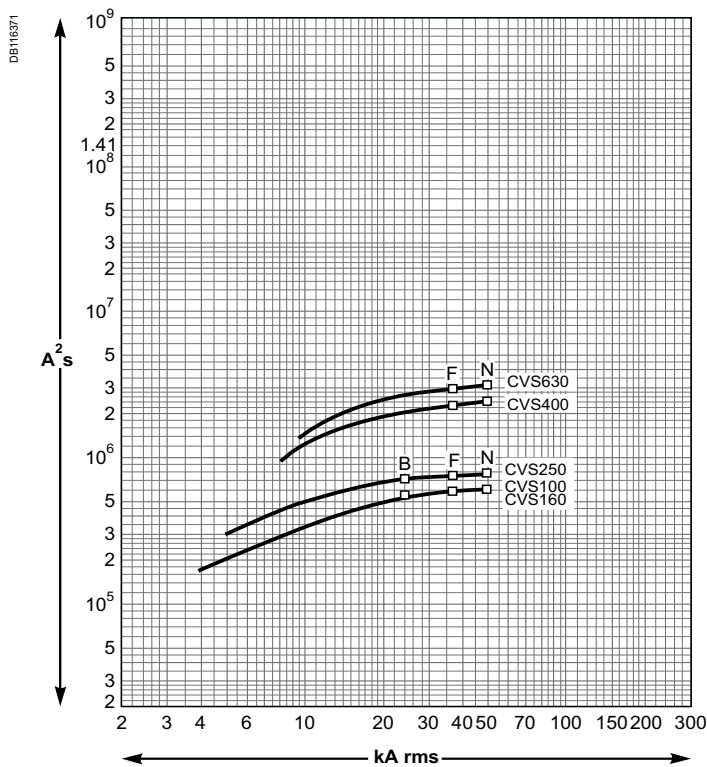

Selectivity

How to use the selectivity tables

Combinations providing full selectivity are indicated by the symbol T (up to downstream breaker Icu)

If selectivity is partial, the table indicates the maximum fault current value (kA) until which selectivity is ensured.

Requisite conditions

The value indicated in the tables are valid for operational rated voltage 380V 400V 415V 50-60Hz.

Following ratios shall be respected in order to avoid overlapping of tripping curves.

Upstream	Downstream	I _r up / I _r down	I _m up / I _m down
TM	TM	1.6	2
	MA + O/L	3	2
ETU	TM	1.6	2
	ETU	1,3 (1)	1.5
	MA + O/L	3	2
Micrologic	TM	1.6	2
	ETU	1,3 (1)	1.5
	MA + O/L	3	2

When Magnetic threshold is adjustable, table are based on maximum setting

I_m (= 10xI_r typically)

When t_r is adjustable t_r upstream > t_r downstream

When t_{sd} is adjustable t_{sd} upstream > t_{sd} downstream

Selectivity

Upstream: EasyPact CVS16-250 B/F/N

Downstream: iK60N

$U_e \leq 415 \text{ Vac}$

Upstream Trip Unit		EasyPact CVS100 B/F/N TM•D					CVS160 B/F/N TM•D						CVS250 B/F/N TM•D		
Downstream Rating	Im	16 190	25 300	32 400	40 500	50 500	63 500	80 640	100 800	100 800	125 1250	160 1250	160 1250	200 1000 2000	250 1250 2000
Selectivity Limit (kA)															
iK60N	≤ 10	0.19	0.3	0.4	0.9	0.9	0.9	0.63	0.8	0.8	2.5	5	5	T	T
B-C Curves	16		0.3	0.4	0.5	0.5	0.5	0.63	0.8	0.8	3	3	3	T	T
1P 230V	20			0.4	0.5	0.5	0.5	0.63	0.8	0.8	2.5	2.5	2.5	T	T
2,3,4P 400V	25				0.5	0.5	0.5	0.63	0.8	0.8	2	2	2	T	T
	32					0.5	0.5	0.63	0.8	0.8	1.5	1.5	1.5	5	T
	40						0.5	0.63	0.8	0.8	1.5	1.5	1.5	4.5	T
	50							0.63	0.8	0.8	1.5	1.5	1.5	4	T
	63								0.8	0.8	1.5	1.5	1.5	3	5

Selectivity limit = 4kA

Total selectivity, up to the breaking capacity of the downstream circuit breaker.

No Selectivity

Nota: respect the basic rules of selectivity for overload and short-circuit.
See Introduction

Selectivity

Upstream: EasyPact CVS100BS

Downstream: iK60N

$U_e \leq 415 \text{ Vac}$

Upstream Trip Unit		EasyPact CVS100BS TM-D								
Downstream Rating Im		16	20	25	32	40	50	63	80	100
		300	300	300	300	500	500	750	1000	1000
Selectivity Limit (kA)										
iK60N	≤ 10	0.3	0.3	0.3	0.3	0.5	0.5	0.75	1	1
B-C Curves	16			0.3	0.3	0.5	0.5	0.75	1	1
1P 230V	20				0.3	0.5	0.5	0.75	1	1
2,3,4P 400V	25					0.5	0.5	0.75	1	1
	32						0.5	0.75	1	1
	40							0.75	1	1
	50								1	1
	63								1	1

Selectivity limit = 4kA

Total selectivity, up to the breaking capacity of the downstream circuit breaker.

No Selectivity

Nota: respect the basic rules of selectivity for overload and short-circuit. See Introduction

Selectivity

Upstream: EasyPact CVS16-250 B/F/N

Downstream: EasyPact CVS16-250 BS/B/F/N

Ue ≤ 415 Vac

Upstream Trip Unit		EasyPact CVS100 B/F/N TM·D					CVS160 B/F/N TM·D					CVS250 B/F/N TM·D				
Downstream	Rating Im	16 190	25 300	32 400	40 500	50 500	63 500	80 640	100 800	100 800	125 1250	160 1250	160 1250	200 1000 2000	250 1250 2000	
Selectivity Limit (kA)																
CVS100 BS TM·D	16		0.3	0.4	0.5	0.5	0.5	0.63	0.8	0.8	1.25	1.25	1.25	1-2	1,25 - 2,5	
	20			0.4	0.5	0.5	0.5	0.63	0.8	0.8	1.25	1.25	1.25	1-2	1,25 - 2,5	
	25				0.5	0.5	0.5	0.63	0.8	0.8	1.25	1.25	1.25	1-2	1,25 - 2,5	
	32					0.5	0.5	0.63	0.8	0.8	1.25	1.25	1.25	1-2	1,25 - 2,5	
	40						0.5	0.63	0.8	0.8	1.25	1.25	1.25	1-2	1,25 - 2,5	
	50							0.63	0.8	0.8	1.25	1.25	1.25	1-2	1,25 - 2,5	
	63								0.8	0.8	1.25	1.25	1.25	1-2	1,25 - 2,5	
	80									0.8	0.8	1.25	1.25	1.25	1-2	1,25 - 2,5
100										1.25	1.25	1.25	1-2	1,25 - 2,5		
CVS100 B/F/N TM·D	16		0.3	0.4	0.5	0.5	0.5	0.63	0.8	0.8	1.25	1.25	1.25	1-2	1,25 - 2,5	
	25				0.5	0.5	0.5	0.63	0.8	0.8	1.25	1.25	1.25	1-2	1,25 - 2,5	
	32					0.5	0.5	0.63	0.8	0.8	1.25	1.25	1.25	1-2	1,25 - 2,5	
	40						0.5	0.63	0.8	0.8	1.25	1.25	1.25	1-2	1,25 - 2,5	
	50							0.63	0.8	0.8	1.25	1.25	1.25	1-2	1,25 - 2,5	
	63								0.8	0.8	1.25	1.25	1.25	1-2	1,25 - 2,5	
	80									0.8	0.8	1.25	1.25	1.25	1-2	1,25 - 2,5
100										1.25	1.25	1.25	1-2	1,25 - 2,5		
CVS160 B/F/N TM·D	100										1.25	1.25	1-2	1,25 - 2,5		
	125												1-2	1,25 - 2,5		
	160													1,25 - 2,5		

Selectivity limit = 4kA

Total selectivity, up to the breaking capacity of the downstream circuit breaker.

No Selectivity

Nota: respect the basic rules of selectivity for overload and short-circuit. See Introduction

Selectivity

Upstream: EasyPact CVS320-600 F/N TM•D

Downstream: iK60N

Ue ≤ 415 Vac

Upstream Trip Unit		CVS320 F/N TM•D				CVS400 F/N TM•D				CVS500 F/N TM•D				CVS600 F/N TM•D			
Downstream	Rating	320				400				500				600			
	Setting	225	255	290	320	280	320	360	400	350	400	450	500	420	480	540	630
	I _m (kA)	3.2				4				5				5			
		I _m = 5- 10I _n				I _m = 5- 10I _n				I _m = 5- 10I _n				I _m = 4- 8I _n			
Selectivity Limit (kA)																	
iK60N	≤ 10	T	T	T	T	T	T	T	T	T	T	T	T	T	T	T	T
B-C Curves	16	T	T	T	T	T	T	T	T	T	T	T	T	T	T	T	T
1P 230V	20	T	T	T	T	T	T	T	T	T	T	T	T	T	T	T	T
2,3,4P 400V	25	T	T	T	T	T	T	T	T	T	T	T	T	T	T	T	T
	32	T	T	T	T	T	T	T	T	T	T	T	T	T	T	T	T
	40	T	T	T	T	T	T	T	T	T	T	T	T	T	T	T	T
	50	T	T	T	T	T	T	T	T	T	T	T	T	T	T	T	T
	63	T	T	T	T	T	T	T	T	T	T	T	T	T	T	T	T

Selectivity limit = 4kA

Total selectivity, up to the breaking capacity of the downstream circuit breaker.

No Selectivity

Nota: respect the basic rules of selectivity for overload and short-circuit. See Introduction

Selectivity

Upstream: EasyPact CVS400/600 F/N ETS

Downstream: iK60N

$U_e \leq 415 \text{ Vac}$

Upstream Trip Unit		EasyPact CVS400 F/N ETS						EasyPact CVS600 F/N ETS					
Downstream Rating Setting		400	250	280	320	360	400	630	400	440	500	570	630
		Im = 2- 10I _r i = 11I _n						Im = 2- 10I _r i = 11I _n					
Selectivity Limit (kA)													
iK60N	≤ 10	T	T	T	T	T	T	T	T	T	T	T	T
B-C Curves	16	4	T	T	T	T	T	T	T	T	T	T	T
1P 230V	20	4	T	T	T	T	T	T	T	T	T	T	T
2,3,4P 400V	25	4	T	T	T	T	T	T	T	T	T	T	T
	32	3.5	T	T	T	T	T	T	T	T	T	T	T
	40	3.5	T	T	T	T	T	T	T	T	T	T	T
	50	3	4	T	T	T	T	T	T	T	T	T	T
	63	3	4	T	T	T	T	T	T	T	T	T	T

Selectivity limit = 4kA

Total selectivity, up to the breaking capacity of the downstream circuit breaker.

No Selectivity

Nota: respect the basic rules of selectivity for overload and short-circuit. See Introduction

Selectivity

Upstream: EasyPact CVS320-600 F/N TM•D

Downstream: EasyPact CVS

$U_e \leq 415 \text{ Vac}$

Upstream Trip Unit		CVS320 F/N TM•D				CVS400 F/N TM•D				CVS500 F/N TM•D				CVS600 F/N TM•D			
Downstream	Rating	320				400				500				600			
	I _r (A)	225	255	290	320	280	320	360	400	350	400	450	500	420	480	540	630
	I _m (kA)	3.2				4				5				5			
		I _m = 5- 10I _n				I _m = 5- 10I _n				I _m = 5- 10I _n				I _m = 4- 8I _n			
Selectivity Limit (kA)																	
CVS100 BS	16	3.2	3.2	3.2	3.2	4	4	4	4	7	7	7	7	7	7	7	7
TM•D	20	3.2	3.2	3.2	3.2	4	4	4	4	6	6	6	6	6	6	6	6
	25	3.2	3.2	3.2	3.2	4	4	4	4	6	6	6	6	6	6	6	6
	32	3.2	3.2	3.2	3.2	4	4	4	4	5	5	5	5	5	5	5	5
	40	3.2	3.2	3.2	3.2	4	4	4	4	5	5	5	5	5	5	5	5
	50	3.2	3.2	3.2	3.2	4	4	4	4	5	5	5	5	5	5	5	5
	63	3.2	3.2	3.2	3.2	4	4	4	4	5	5	5	5	5	5	5	5
	80	3.2	3.2	3.2	3.2	4	4	4	4	5	5	5	5	5	5	5	5
	100	3.2	3.2	3.2	3.2	4	4	4	4	5	5	5	5	5	5	5	5
CVS100 B/F/N	16	3.2	3.2	3.2	3.2	4	4	4	4	7	7	7	7	7	7	7	7
TM•D	25	3.2	3.2	3.2	3.2	4	4	4	4	6	6	6	6	6	6	6	6
	32	3.2	3.2	3.2	3.2	4	4	4	4	5	5	5	5	5	5	5	5
	40	3.2	3.2	3.2	3.2	4	4	4	4	5	5	5	5	5	5	5	5
	50	3.2	3.2	3.2	3.2	4	4	4	4	5	5	5	5	5	5	5	5
	63	3.2	3.2	3.2	3.2	4	4	4	4	5	5	5	5	5	5	5	5
	80	3.2	3.2	3.2	3.2	4	4	4	4	5	5	5	5	5	5	5	5
	100	3.2	3.2	3.2	3.2	4	4	4	4	5	5	5	5	5	5	5	5
CVS 160 B/F/N	100	3.2	3.2	3.2	3.2	4	4	4	4	5	5	5	5	5	5	5	5
TM•D	125	3.2	3.2	3.2	3.2	4	4	4	4	5	5	5	5	5	5	5	5
	160			3.2	3.2	4	4	4	4	5	5	5	5	5	5	5	5
CVS 250 B/F/N	160			3.2	3.2	4	4	4	4	5	5	5	5	5	5	5	5
TM•D	200							4	4	5	5	5	5	5	5	5	5
	250								4		5	5	5		5	5	5
CVS400 F/N	320															5	5
TM-D	400																5
CVS400 F/N ETS	400																5

4 Selectivity limit = 4kA

T Total selectivity, up to the breaking capacity of the downstream circuit breaker.

No Selectivity

Nota: respect the basic rules of selectivity for overload and short-circuit. See Introduction

Selectivity

Upstream: **EasyPact CVS400/600 F/N ETS**

Downstream: **EasyPact CVS**

Ue ≤ 415 Vac

Upstream Trip Unit		EasyPact CVS400 F/N ETS						EasyPact CVS600 F/N ETS					
Downstream	Rating	400						630					
	I _r (A)	200	250	280	320	360	400	315	400	440	500	570	630
	I _m (kA)	2	2.5	2.8	3.2	3.6	4	3.1	4	4.4	5	5.7	6.3
		I _m = 2- 10I _r I _i = 11I _n						I _m = 2- 10I _r I _i = 11I _n					
Selectivity Limit (kA)													
EasyPact CVS100 BS	16	2	2.5	2.8	3.2	3.6	4	3.1	4	5	7	10	15
TM•D	20	2	2.5	2.8	3.2	3.6	4	3.1	4	5	6	10	12
	25	2	2.5	2.8	3.2	3.6	4	3.1	4	5	6	10	12
	32	2	2.5	2.8	3.2	3.6	4	3.1	4	4.4	6	7	10
	40	2	2.5	2.8	3.2	3.6	4	3.1	4	4.4	6	7	10
	50	2	2.5	2.8	3.2	3.6	4	3.1	4	4.4	5.5	6.6	8
	63	2	2.5	2.8	3.2	3.6	4	3.1	4	4.4	5	5.7	7
	80	2	2.5	2.8	3.2	3.6	4	3.1	4	4.4	5	5.7	6.3
100	2	2.5	2.8	3.2	3.6	4	3.1	4	4.4	5	5.7	6.3	
EasyPact CVS100 B/F/N	16	2	2.5	2.8	3.2	3.6	4	3.1	4	5	7	10	15
TM•D	25	2	2.5	2.8	3.2	3.6	4	3.1	4	5	6	10	12
	32	2	2.5	2.8	3.2	3.6	4	3.1	4	4.4	6	7	10
	40	2	2.5	2.8	3.2	3.6	4	3.1	4	4.4	6	7	10
	50	2	2.5	2.8	3.2	3.6	4	3.1	4	4.4	5.5	6.6	8
	63	2	2.5	2.8	3.2	3.6	4	3.1	4	4.4	5	5.7	7
	80	2	2.5	2.8	3.2	3.6	4	3.1	4	4.4	5	5.7	6.3
	100	2	2.5	2.8	3.2	3.6	4	3.1	4	4.4	5	5.7	6.3
CVS160 B/F/N	100	2	2.5	2.8	3.2	3.6	4	3.1	4	4.4	5	5.7	6.3
TM•D	125	2	2.5	2.8	3.2	3.6	4	3.1	4	4.4	5	5.7	6.3
	160			2.8	3.2	3.6	4	3.1	4	4.4	5	5.7	6.3
CVS250 B/F/N	160			2.8	3.2	3.6	4	3.1	4	4.4	5	5.7	6.3
TM•D	200					3.6	4	3.1	4	4.4	5	5.7	6.3
	250						4		4	4.4	5	5.7	6.3
CVS400 F/N TM-D	320											5.7	6.3
	400												6.3
CVS400 F/N ETS	400												6.3

4 Selectivity limit = 4kA

T Total selectivity, up to the breaking capacity of the downstream circuit breaker.

No Selectivity

Nota: respect the basic rules of selectivity for overload and short-circuit. See Introduction

$U_e \leq 415 \text{ Vac}$

Upstream Trip Unit		Comapct NS 630-1600 N Micrologic 2 Isd = 10In						Comapct NS 630-1600 N Micrologic 5,6 Inst 15In or OFF					
Downstream	Rating Setting Ir (A)	400	630	800	1000	1250	1600	400	630	800	1000	1250	1600
Selectivity Limit (kA)													
CVS 100 BS	16	T	T	T	T	T	T	T	T	T	T	T	T
TM•D	20	T	T	T	T	T	T	T	T	T	T	T	T
	25	T	T	T	T	T	T	T	T	T	T	T	T
	32	T	T	T	T	T	T	T	T	T	T	T	T
	40	T	T	T	T	T	T	T	T	T	T	T	T
	50	T	T	T	T	T	T	T	T	T	T	T	T
	63	T	T	T	T	T	T	T	T	T	T	T	T
	80	T	T	T	T	T	T	T	T	T	T	T	T
	100	T	T	T	T	T	T	T	T	T	T	T	T
CVS 100 B/F/N	16	T	T	T	T	T	T	T	T	T	T	T	T
TM•D	25	T	T	T	T	T	T	T	T	T	T	T	T
	32	T	T	T	T	T	T	T	T	T	T	T	T
	40	T	T	T	T	T	T	T	T	T	T	T	T
	50	T	T	T	T	T	T	T	T	T	T	T	T
	63	T	T	T	T	T	T	T	T	T	T	T	T
	80	T	T	T	T	T	T	T	T	T	T	T	T
	100	T	T	T	T	T	T	T	T	T	T	T	T
CVS 160 B/F/N	100	T	T	T	T	T	T	T	T	T	T	T	T
TM•D	125	T	T	T	T	T	T	T	T	T	T	T	T
	160	T	T	T	T	T	T	T	T	T	T	T	T
CVS 250 B/F/N	160	T	T	T	T	T	T	T	T	T	T	T	T
TM•D	200	T	T	T	T	T	T	T	T	T	T	T	T
	250	T	T	T	T	T	T	T	T	T	T	T	T
CVS 400 F/N	320		T	T	T	T	T		T	T	T	T	T
TM•D	400		T	T	T	T	T		T	T	T	T	T
CVS 600 F/N	500		T	T	T	T	T		T	T	T	T	T
TM•D	600		T	T	T	T	T		T	T	T	T	T
CVS 400F/N	320		T	T	T	T	T		T	T	T	T	T
ETU	400		T	T	T	T	T		T	T	T	T	T
CVS 630F/N	500			T	T	T	T			T	T	T	T
ETU	630				T	T	T				T	T	T

Upstream Trip Unit		Comapct NS 630-1600 N Micrologic 2 Isd = 10In						Comapct NS 630-1600 N Micrologic 5,6 Inst 15In or OFF					
Downstream	Rating Setting Ir (A)	400	630	800	1000	1250	1600	400	630	800	1000	1250	1600
Selectivity Limit (kA)													
CVS 100 B/F	2.5	T	T	T	T	T	T	T	T	T	T	T	T
MA + O/L R	6.3	T	T	T	T	T	T	T	T	T	T	T	T
	12.5	T	T	T	T	T	T	T	T	T	T	T	T
	25	T	T	T	T	T	T	T	T	T	T	T	T
	50	T	T	T	T	T	T	T	T	T	T	T	T
	100	T	T	T	T	T	T	T	T	T	T	T	T
CVS 160 B/F	100	T	T	T	T	T	T	T	T	T	T	T	T
MA + O/L R	150		T	T	T	T	T		T	T	T	T	T
	100	T	T	T	T	T	T	T	T	T	T	T	T
CVS 250 B/F	220			T	T	T	T			T	T	T	T
MA + O/L R					T	T	T				T	T	T
CVS 400 F/N	320				T	T	T				T	T	T
MA + O/L R													
CVS 600 F/N	500						T						T
MA + O/L R													

4 Selectivity limit = 4kA

T Total selectivity, up to the breaking capacity of the downstream circuit breaker.

No Selectivity

Nota: respect the basic rules of selectivity for overload and short-circuit. See Introduction

What is cascading (or Back up Protection) ?

Cascading is the use of the current limiting capacity of circuit breakers at a given point to permit installation of lower-rated and therefore lower-cost circuit breakers downstream. The upstream circuit breakers acts as a barrier against short-circuit currents. In this way, downstream circuit breakers with lower breaking capacities than the prospective short-circuit (at their point of installation) operate under their normal breaking conditions. Since the current is limited throughout the circuit controlled by the limiting circuit breaker, cascading applies to all switchgear downstream. It is not restricted to two consecutive devices.

General use of cascading

With cascading, the devices can be installed in different switchboards. Thus, in general, cascading refers to any combination of circuit breakers where a circuit breaker with a breaking capacity less than the prospective I_{sc} at its point of installation can be used. Of course, the breaking capacity of the upstream circuit breaker must be greater than or equal to the prospective short-circuit current at its point of installation.

Coordination between circuit breakers

The use of a protective device possessing a breaking capacity less than the prospective short-circuit current at its installation point is permitted as long as another device is installed upstream with at least the necessary breaking capacity. In this case, the characteristics of the two devices must be coordinated in such a way that the energy let through by the upstream device is not more than that which can be withstood by the downstream device and the cables protected by these devices without damage. Cascading can only be checked by laboratory tests and the possible combinations can be specified only by the circuit breaker manufacturer.

Cascading

Upstream: **EasyPact CVS**

Downstream: iC60, C120, **EasyPact CVS**

$U_e \leq 415 \text{ Vac}$

Upstream		CVS100			CVS100			CVS160			CVS250			CVS400		CVS630	
Downstream		BS	B	F	N	B	F	N	B	F	N	F	N	F	N		
	$I_{cu} \text{ (kA) } 415\text{V}$	25	25	36	50	25	36	50	25	36	50	36	50	36	50		
Downstream																	
iK60N	6	10	10	10	10	10	10	10	10	10	10						
CVS100BS	25			36	36		36	36		36	36	36	36	36	36		
CVS100B	25			36	36		36	36		36	36	36	36	36	36		
CVS100F	36				50			50			50		50		50		
CVS160B	25				36			36		36	36	36	36	36	36		
CVS160F	36				50			50			50		50		50		
CVS250B	25											36	36	36	36		
CVS250F	36												50		50		
CVS400F	36												50		50		
CVS400N	50														50		

Switch disconnecter coordination

upstream: Circuit breaker **EasyPact** CVS or gG fuses

Downstream: Switch disconnecter **EasyPact** CVS NA

$U_e \leq 415 \text{ Vac}$

Switch disconnecter Compact NA		CVS100NA	CVS160NA	CVS250NA	CVS400NA	CVS630NA
Upstream protection = CVS						
type / rating (A)		CVS100B/100	CVS160B/160	CVS250B/250		
Conditionnal short circuit current	kA rms	25	25	25		
making current	kA peak	53	53	53		
type / rating (A)		CVS100F/100	CVS160F/160	CVS250F/250	CVS400F/400	CVS630F/630
Conditionnal short circuit current	kA rms	36	36	36	36	36
making current	kA peak	76	76	76	76	76
type / rating (A)		CVS100N/100	CVS160N/160	CVS250N/250	CVS400N/400	CVS630N/630
Conditionnal short circuit current	kA rms	50	50	50	50	50
making current	kA peak	105	105	105	105	105
type / rating (A)					CVS400H/400	CVS630H/630
Conditionnal short circuit current	kA rms				70	70
making current	kA peak				154	154
Upstream protection = gG fuses						
type / rating (A)		gG 80	gG 125	gG 200	gG 315	gG 500
Conditionnal short circuit current	kA rms	100	100	100	100	100
making current	kA peak	220	220	220	220	220
making current	kA peak					



Catalogue numbers



Catalogue numbers

<i>Functions and characteristics</i>	A-1
<i>Installation recommendations</i>	B-1
<i>Dimensions and connection</i>	C-1
<i>Additional characteristics</i>	D-1

EasyPact CVS100 to 250	E-3
-------------------------------	------------

EasyPact CVS400 to 630	E-13
-------------------------------	-------------

<i>EasyPact CVS100BS</i>	F-1
--------------------------	-----

EasyPact CVS100 to 250

CVS100/160/250B: complete fixed/FC device EasyPact CVS100/160/250B with TM-D, TM-G (25kA 380/415 V)	E-3 E-3
CVS100/160/250F: complete fixed/FC device EasyPact CVS100/160/250F with TM-D, MA (36kA 380/415 V)	E-4 E-4
CVS100/160/250N: complete fixed/FC device EasyPact CVS100/160/250N with TM-D, MA (50kA 380/415 V)	E-5 E-5
CVS100/160/250NA: complete fixed/FC device EasyPact CVS100/160/250NA	E-6 E-6
Add-on Vigi module: EasyPact and Vigi CVS100/160/250	E-7 E-7
Accessories EasyPact and Vigi CVS100/160/250	E-8 E-8

CVS100/160/250B: complete fixed/FC device

EasyPact CVS100/160/250B
(25 kA 380/415 V)

EasyPact CVS100/160/250B

With TM-D thermal-magnetic trip unit

DB400150

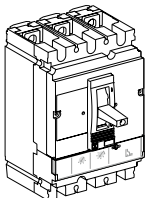

EasyPact CVS100B (25 kA at 380/415 V)			
Rating	3P 3d	4P 3d	4P 4d
TM16D	LV510300	LV510310	
TM25D	LV510301	LV510311	LV510321
TM32D	LV510302	LV510312	LV510322
TM40D	LV510303	LV510313	LV510323
TM50D	LV510304	LV510314	LV510324
TM63D	LV510305	LV510315	LV510325
TM80D	LV510306	LV510316	LV510326
TM100D	LV510307	LV510317	LV510327
EasyPact CVS160B (25 kA at 380/415 V)			
Rating	3P 3d	4P 3d	4P 4d
TM100D	LV516301	LV516311	
TM125D	LV516302	LV516312	LV516322
TM160D	LV516303	LV516313	LV516323
EasyPact CVS250B (25 kA at 380/415 V)			
Rating	3P 3d	4P 3d	4P 4d
TM160D	LV525301		
TM200D	LV525302	LV525312	LV525322
TM250D	LV525303	LV525313	LV525323

EasyPact CVS160/250B

With TM-G thermal-magnetic trip unit

DB400150

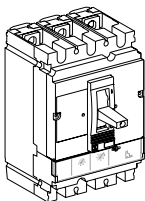

EasyPact CVS160B (25 kA at 380/415 V)		
Rating	3P 3d	4P 3d
TM80G	LV510736	LV510748
TM100G	LV510737	LV510749
TM125G	LV516732	LV516742
TM160G	LV516733	LV516743
EasyPact CVS250B (25 kA at 380/415 V)		
Rating	3P 3d	4P 3d
TM200G	LV525732	LV525742
TM250G	LV525733	LV525743

CVS100/160/250F: complete fixed/FC device

EasyPact CVS100/160/250F
(36 kA 380/415 V)

EasyPact CVS100/160/250F

With TM-D thermal-magnetic trip unit

DB400150

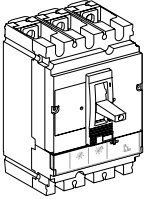

EasyPact CVS100F (36 kA at 380/415 V)			
Rating	3P 3d	4P 3d	4P 4d
TM16D	LV510330	LV510340	
TM25D	LV510331	LV510341	
TM32D	LV510332	LV510342	LV510352
TM40D	LV510333	LV510343	LV510353
TM50D	LV510334	LV510344	LV510354
TM63D	LV510335	LV510345	LV510355
TM80D	LV510336	LV510346	LV510356
TM100D	LV510337	LV510347	LV510357
EasyPact CVS160F (36 kA at 380/415 V)			
Rating	3P 3d	4P 3d	4P 4d
TM100D	LV516331	LV516341	
TM125D	LV516332	LV516342	LV516352
TM160D	LV516333	LV516343	LV516353
EasyPact CVS250F (36 kA at 380/415 V)			
Rating	3P 3d	4P 3d	4P 4d
TM160D	LV525331		
TM200D	LV525332	LV525342	LV525352
TM250D	LV525333	LV525343	LV525353

EasyPact CVS100/160/250F

With MA magnetic trip unit

DB400150

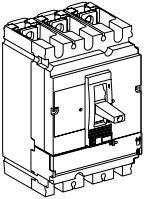

EasyPact CVS100F (36 kA at 380/415 V)	
Rating	3P 3d
MA2.5	LV510440
MA6.3	LV510441
MA12.5	LV510442
MA25	LV510443
MA50	LV510444
MA100	LV510445
EasyPact CVS160F (36 kA at 380/415 V)	
Rating	3P 3d
MA100	LV516439
MA150	LV516440
EasyPact CVS250F (36 kA at 380/415 V)	
Rating	3P 3d
MA220	LV525439

CVS100/160/250N: complete fixed/FC device

EasyPact CVS100/160/250N
(50 kA 380/415 V)

EasyPact CVS160/250N

With TM-D thermal-magnetic trip unit

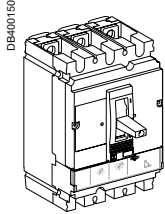

EasyPact CVS100N (50 kA at 380/415 V)		
Rating	3P 3d	4P 3d
TM16D	LV510470	LV510480
TM25D	LV510471	LV510481
TM32D	LV510472	LV510482
TM40D	LV510473	LV510483
TM50D	LV510474	LV510484
TM63D	LV510475	LV510485
TM80D	LV510476	LV510486
TM100D	LV510477	LV510487
EasyPact CVS160N (50 kA at 380/415 V)		
Rating	3P 3d	4P 3d
TM100D	LV516461	LV516466
TM125D	LV516462	LV516467
TM160D	LV516463	LV516468
EasyPact CVS250N (50 kA at 380/415 V)		
Rating	3P 3d	4P 3d
TM200D	LV525452	LV525457
TM250D	LV525453	LV525458

EasyPact CVS100/160/250N

With MA magnetic trip unit

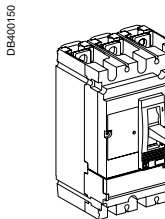

EasyPact CVS100N (50 kA at 380/415 V)		
Rating	3P 3d	
MA2.5	LV510450	
MA6.3	LV510451	
MA12.5	LV510452	
MA25	LV510453	
MA50	LV510454	
MA100	LV510455	
EasyPact CVS160N (50 kA at 380/415 V)		
Rating	3P 3d	
MA100	LV516450	
MA150	LV516451	
EasyPact CVS250N (50 kA at 380/415 V)		
Rating	3P 3d	
MA220	LV525442	

CVS100/160/250NA: complete fixed/FC device

EasyPact CVS100/160/250NA

EasyPact CVS100/160/250NA switch-disconnector

With NA switch-disconnector unit

DB400155

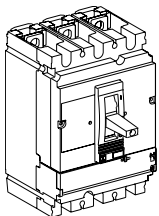

EasyPact CVS100NA		
Rating	3P	4P
100	LV510425	LV510426
EasyPact CVS160NA		
Rating	3P	4P
160	LV516425	LV516426
EasyPact CVS250NA		
Rating	3P	4P
250	LV525425	LV525426

+ Vigi module

Vigi module

DB111464

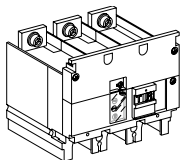



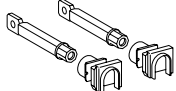

	3P	4P
CVS100/160 (220 to 440 V)	LV429210	LV429211
CVS250 (220 to 440 V)	LV431535	LV431536

Connection accessories (Cu or Al)

Rear connections

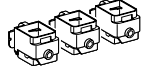
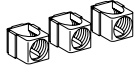
DB112225		2 short			LV429235
		2 long			LV429236

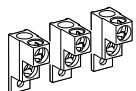
Bare cable connectors

DB112226		Steel connectors	1 x (1.5 to 95 mm ²) ; ≤ 160 A	Set of 3	LV429242
				Set of 4	LV429243
DB112225		Aluminium connectors	1 x (25 to 95 mm ²) ; ≤ 250 A	Set of 3	LV429227
				Set of 4	LV429228
				Set of 3	LV429259
				Set of 4	LV429260
DB112726		Clips for connectors		Set of 10	LV429241
DB112227		Aluminium connectors for 2 cables ⁽¹⁾	2 x (50 to 120 mm ²) ; ≤ 250 A	Set of 3	LV429218
				Set of 4	LV429219
DB112724		6.35 mm voltage tap for steel or aluminium connectors		Set of 10	LV429348

Terminal extensions

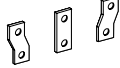
DB112235		Spreaders from 35 to 45 mm pitch ⁽¹⁾	Set of 3	LV431563
			Set of 4	LV431564

⁽¹⁾ Supplied with 2 or 3 interphase barriers.

Insulation accessories

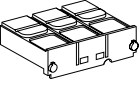
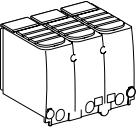
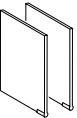
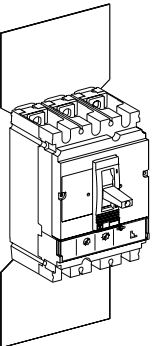
DB112238 	1 short terminal shield for breaker	3 P	LV429515
		4 P	LV429516
DB400045 	1 long terminal shield for breaker	3 P	LV429517
		4 P	LV429518
DB400061 	Interphase barriers for breaker	Set of 6	LV429329
DB400163 	2 insulating screens for breaker (45 mm pitch)	3 P	LV429330
		4 P	LV429331

(1) Supplied with 2 or 3 interphase barriers.

Electrical auxiliaries

Auxiliary contacts (changeover)

DB112254		OF or SD or SDE or SDV	29450
		OF or SD or SDE or SDV low level	29452

CDB600821-00		SDE adaptor, mandatory for trip unit TM, MA	LV429451
--------------	---	---	----------

Voltage releases

DB111454		Voltage	MX	MN	
		AC	110-130 V 50/60 Hz	LV429386	LV429406
			220-240 V 50/60 Hz and 208-277 V 60 Hz	LV429387	LV429407
		DC	24 V	LV429390	LV429410

Rotary handles

Direct rotary handle

DB112269

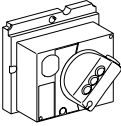

With black handle

LV429337

Extended rotary handle

DB112260

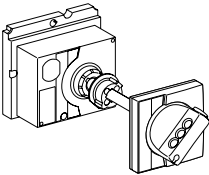

With black handle

LV429338

Locks

Toggle locking device for 1 to 3 padlocks

DB400164

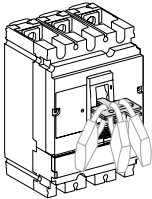

By removable device

29370

DB400165

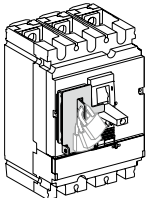

By fixed device

29371

Locking of rotary handle

DB112263

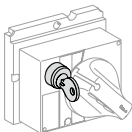

Keylock adaptor (keylock not included)

LV429344

Keylock (keylock adaptor not included)

Ronis 1351B.500

41940

Profalux KS5 B24 D4Z

42888

EasyPact CVS400 to 630

CVS400/630: complete fixed/FC device	E-13
EasyPact CVS400/630F with TM-D (36 kA 380/415 V)	E-13
EasyPact CVS400/630N with TM-D (50 kA 380/415 V)	E-13
EasyPact CVS400/630F/N with MA (36/50 kA 380/415 V)	E-13
EasyPact CVS400/630F/N with ETS2.3 (36/50 kA 380/415 V)	E-14
EasyPact CVS400/630NA switch-disconnector	E-14
Add-on Vigi module: EasyPact and Vigi	E-14
Accessories	E-15
EasyPact and Vigi CVS400/630	E-15

CVS400/630: complete fixed/FC device

EasyPact CVS400/630F/N (36/50 kA 380/415 V)

EasyPact CVS400/630F

With TM-D thermal-magnetic trip unit

DE400008

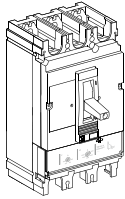

EasyPact CVS400F (36 kA at 380/415 V)

Rating	3P 3d	4P 3d	4P 4d
TM320D	LV540305	LV540308	LV540311
TM400D	LV540306	LV540309	LV540312

EasyPact CVS630F (36 kA at 380/415 V)

Rating	3P 3d	4P 3d	4P 4d
TM500D	LV563305	LV563308	LV563311
TM600D	LV563306	LV563309	LV563312

EasyPact CVS400/630N

With TM-D thermal-magnetic trip unit

DE400008

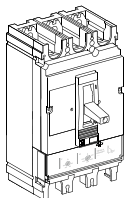

EasyPact CVS400N (50 kA at 380/415 V)

Rating	3P 3d	4P 3d	4P 4d
TM320D	LV540315	LV540318	
TM400D	LV540316	LV540319	LV540322

EasyPact CVS630N (50 kA at 380/415 V)

Rating	3P 3d	4P 3d	4P 4d
TM500D	LV563315	LV563318	LV563321
TM600D	LV563316	LV563319	LV563322

EasyPact CVS400/630F/N

With MA magnetic trip unit

DE400020

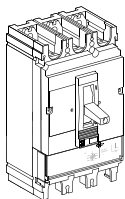

EasyPact CVS400F (36 kA at 380/415 V)

Rating	3P 3D
MA320	LV540550

EasyPact CVS400N (50 kA at 380/415 V)

Rating	
MA320	LV540552

EasyPact CVS630F (36 kA at 380/415 V)

Rating	
MA500	LV563550

EasyPact CVS630N (50 kA at 380/415 V)

Rating	
MA500	LV563552

CVS400/630: complete fixed/FC device

EasyPact CVS400/630F/N (36/50 kA 380/415 V)

EasyPact CVS400/630F

ETS 2.3 electronic trip unit (LS₀I protection)

DB400021

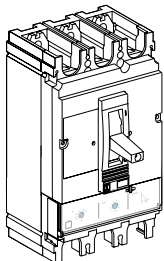

		3P 3d	4P 3d, 4d, 3d + N/2
EasyPact CVS400F (36 kA at 380/415 V)	400 A	LV540505	LV540506
EasyPact CVS630F (36 kA at 380/415 V)	630 A	LV563505	LV563506

EasyPact CVS400/630N

ETS 2.3 electronic trip unit (LS₀I protection)

DB400021

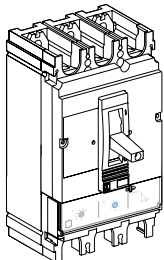

		3P 3d	4P 3d, 4d, 3d + N/2
EasyPact CVS400N (50 kA at 380/415 V)	400 A	LV540510	LV540511
EasyPact CVS630N (50 kA at 380/415 V)	630 A	LV563510	LV563511

EasyPact CVS400/630 NA switch-disconnector

NA switch disconnector

DB400023

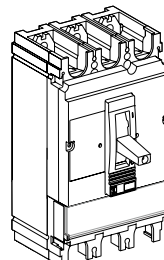

		3P	4P
EasyPact CVS400 NA		LV540400	LV540401
EasyPact CVS630 NA		LV563400	LV563401

+ Vigi module

Vigi module

DB11464

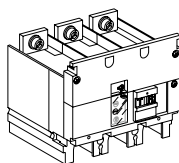

		3P	4P
CVS400/630(200 to 440 V)		LV432455	LV432456

Connection accessories (Cu or Al)

Rear connections

DB112225

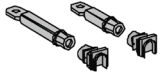

2 short	LV432475
2 long	LV432476

Cable connectors ⁽¹⁾

E22040



Aluminium connector 1x (35 to 300 mm ²)	Set of 3	LV432479
	Set of 4	LV432480

E22041



Aluminium connector 2x (35 to 240 mm ²)	Set of 3	LV432481
	Set of 4	LV432482

Voltage plug for aluminium connector 1 or 2 cables	Set of 10	LV429348
--	-----------	----------

Terminal extension ⁽¹⁾

E21012



Spreaders	52.5 mm	3P	LV432490
		4P	LV432491
	70 mm	3P	LV432492
		4P	LV432493

Insulation accessories

E18618

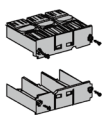

Short terminal shield, 45 mm (1 piece)	3P	LV432591
	4P	LV432592
Long terminal shield, 45 mm (1 piece)	3P	LV432593
	4P	LV432594
Interphase barriers	Set of 6	LV432570

E18606



Long terminal shield for spreaders, 52,5mm (1 piece) (supplied with insulating plate)	3P	LV432595
	4P	LV432596
2 insulating screens (70 mm pitch)	3P	LV432578
	4P	LV432579

⁽¹⁾ supplied with 2 or 3 interphase barriers

Electrical auxiliaries

Auxiliary contacts (changeover)

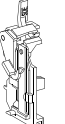
E16808		OF or SD or SDE or SDV	29450
		OF or SD or SDE or SDV low level	29452
CDB600821-00		SDE adaptor mandatory for trip unit TM, MA and ETS2.3	LV540050

Voltage releases

E16809		Voltage	MX	MN	
		AC	110-130 V 50/60 Hz	LV429386	LV429406
			220-240 V 50/60 Hz and 208-277 V 60 Hz	LV429387	LV429407
		DC	24 V	LV429390	LV429410

Rotary handle

Direct rotary handle

E18611

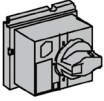

Standard black handle

LV432597

Extended rotary handle

E18612

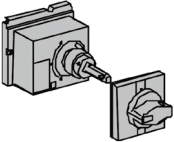

Standard extended rotary handle

LV432598

Locks

Toggle locking device for 1 to 3 padlocks

E18621



By removable device

29370

E18613

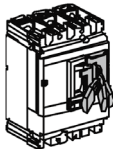

By fixed device

32631

Locking of the rotary handle

E18620

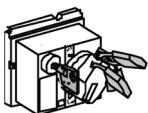

Keylock adaptor (keylock not included)

LV432604

Keylock (keylock adaptor not included)

Ronis 1351B.500

41940

Profalux KS5 B24 D4Z

42888

EasyPact™ CVS100BS



EasyPact CVS100BS

<i>Functions and characteristics</i>	A-1
<i>Installation recommendations</i>	B-1
<i>Dimensions and connection</i>	C-1
<i>Additional characteristics</i>	D-1
<i>Catalogue numbers</i>	E-1

Presentation	F-2
EasyPact CVS100BS	F-2

Overview	F-3
Optimal Combination	F-3

Functions and Characteristics	F-4
General characteristics	F-4
Protection of LV Power Distribution System	
EasyPact CVS100BS	F-5
Installation and Connection	
EasyPact CVS100BS	F-6
Electrical and Mechanical Accessories	
EasyPact CVS100BS	F-7

Technical Data Supplement	F-9
Tripping Curve EasyPact CVS100BS	
Power Distribution Protection System	F-9
Temperature and Altitude Derating	F-11
Current-limiting	F-12
Capacitor protection	F-13

Catalogue numbers	F-14
EasyPact CVS100BS	F-14
Accessories	F-15

Dimensions and Installation	F-17
EasyPact CVS100BS	F-17
Accessories EasyPact CVS100BS	F-19

EasyPact CVS100BS

Simplicity and perfection – That's what Schneider Electric brings to you. EasyPact CVS100BS not only reflects high quality of Schneider Electric, but also features performance, protection functions, and performance/price ratio.

EasyPact CVS100BS

- up to 100A 3 Pole/4 Pole products
- Icu 25kA, Ics 17kA
- Reliable protections of power distribution systems
- Flexible installation solutions including fixed, plug-in types
- Complete solutions for AC and DC networks

More reliable and safer

Powerful current-limiting capacity to ensure more cost-effective and more reliable protection.

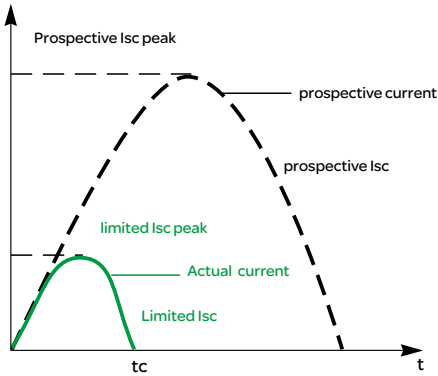

Modularized System

As shown below, a wide range of modules or accessories are available.

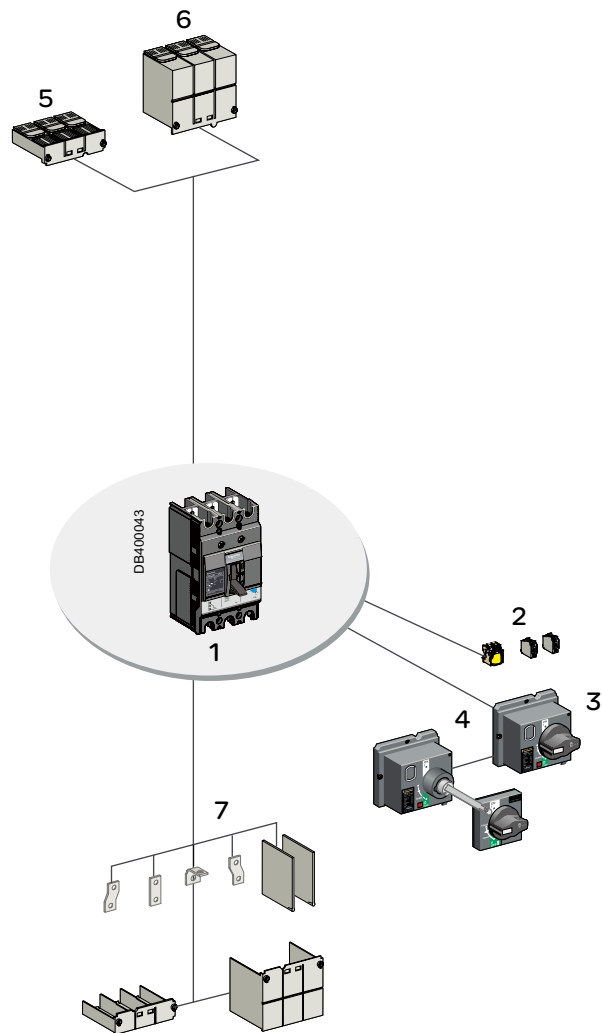

1. Breaking unit
2. MN and MX voltage releases
3. Direct rotary handle
4. Extended rotary handle
5. Short terminal shield
6. Long terminal shield
7. Connection accessories

PB100445



EasyPact CVS100BS

Compliance with standards

- IEC 60947-1: General rules (GB/T 14048.1)
- IEC 60947-2: Circuit Breakers (GB/T 14048.2)
- IEC 60947-4: Contactors and Motor Starters (GB 14048.4)
- IEC 60946-5.1: Control circuit devices and Switching elements; automatic Control Components (GB 14048.5)

Tropicalization

EasyPact CVS100BS circuit breakers have successfully passed the tests prescribed by following standards for extreme atmospheric conditions:

- IEC 68-2-30, damp heat(95% relative humidity at 55°C)
- QIEC 68-2-52 Salt mist (severity level 2)

Positive contact indication

All EasyPact CVS100BS circuit breakers are suitable for isolation as defined in IEC standard 60947-2:

- the isolation position corresponds to the O (OFF) position
- the operating handle cannot indicate the "OFF" position unless the contacts are effectively open
- padlocks may not be installed unless the contacts are open

Installation of a rotary handle or a motor mechanism does not alter the reliability of the position-indication system.

The isolation function is certified by tests guaranteeing:

- the mechanical reliability of the position indication system
- the absence of leakage currents
- overvoltage withstand capacity between upstream and downstream connections



PE100445



EasyPact CVS100BS

EasyPact circuit breaker				CVS100BS
Number of Poles				3, 4
Control	Manual		Toggle	■
			Direct or extended rotary handle	■
Connection	Fixed		Front connection	■
	Plug-in		Front connection	■
Electrical characteristics as per IEC 60947-2 and EN 60947-2				
Rated current (A)	I_n	40°C		100
Rated insulation voltage (V)	U_i			690
Rated impulse withstand voltage (kV)	U_{imp}			6
Rated operational voltage (V)	U_e	AC 50/60 Hz		440
		DC		
Circuit breaker type				BS
Ultimate breaking capacity (kA rms)	I_{cu}	AC 50/60 Hz	220/240 V	50
			380/400 V	25
			415 V	25
Service breaking capacity (kA)	I_{cs}		220/230 V	25kA
			380/400 V	17kA
Suitability for Isolation				■
Utilisation category				A
Durability (C-O cycles)	Mechanical			13000
	Electrical	415 V	I_n	4000
Protection				
Trip units				Thermal-magnetic
Overload protection	Long time	$I_r (I_n \times \dots)$		0.8 to $1 \times I_n$
Short-circuit protection	Short time	$I_{sd} (I_r \times \dots)$		-
	Instantaneous	$I_i (I_n \times \dots)$		■
Indication and control auxiliaries				
Auxiliary switch				■
MX shunt release				■
MN under-voltage release				■
Installation				
Accessories	Terminal extensions and spreaders			-
	Terminal shields			■
	interphase barriers			■
Dimensions (mm) W×H×D	Fixed, front connection 3P/4P			75x130x60/ 100x130x60
				0.78/1.0
Weight (kg)	Fixed, front connection 3P/4P			

Connection of electrical auxiliaries

Fixed configuration

Auxiliary circuits exit the device through a knock-out in the front cover.

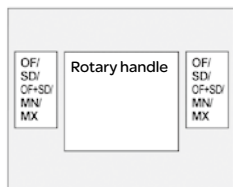

EasyPact CVS100BS

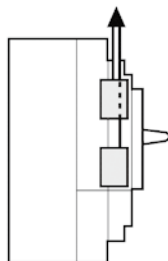

Each auxiliary device is equipped with a terminal block with numbered terminals for connection of wires up to:

- 1.5mm² for auxiliary contacts and voltage releases



EasyPact CVS100BS auxiliary contacts

All auxiliary contacts can be used to switch on/off electronic loads.

EasyPact CVS100BS auxiliary switch

This auxiliary contacts can display the status of circuit breakers remotely, and therefore can be used for indications electrical interlocking, relay control. etc.

Functions

- OF (On/off): Indicate the position of circuit breaker contacts.
- SD (Trip indication): Indicate trip conditions of circuit breakers due to: overload, short-circuit, under-voltage or operation of the "push to trip" button. It returns to de-energised state when the circuit breaker is reset.

EasyPact CVS100BS multifunctional auxiliary switch

- OF/SD (Auxiliary + alarm): Indicate position of circuit breaker contacts and trip conditions of circuit breakers.

Standard

These auxiliary contacts comply with IEC 60947-5.

Installation and connection

- This auxiliary contacts clip into the slot behind the front cover of the circuit breaker.
- The conductor connected to the central terminal block has a cross-section up to 1.0mm².

Electrical characteristics		In: 100A	
Rated thermal current (A)		5	
Minimum load		10mA, 24V	
Utilisation (IEC 947-4-1)		AC12	AC15
Operating current (A)	110V	5	3
	220~240V	3	2
	380~440V	-	-

Voltage tripping

The voltage releases can trip the circuit breaker.

Under-voltage release (MN) trips the circuit breaker:

- When the tripping threshold drops below the rated voltage of the trip unit.
- The tripping threshold is 0.35 to 0.7 times the rated voltage.
- If the circuit breaker can be closed when the voltage exceeds 0.85 times the rated voltage.

Circuit breaker tripping by an MN release meets the requirements of standard IEC60947-2.

Shunt releases (MX)

The circuit breaker will trip by this release if the control voltage exceeds $0.7 \times U_n$. Control signals can be of the impulse type (≥ 20 ms) or maintained.

Operation

- The circuit breaker can be reset locally or remotely after tripping by an MN or MX release.
- MN or MX tripping is faster than manual tripping (or trip by electric mechanism). In the presence of a standing trip order, other operations will not be executed.
- Endurance:
 - EasyPact CVS100BS circuit breaker, typically 50% of the rated mechanical endurance of the circuit breaker

Installation and connection

- The circuit breaker panel has MX and MN releases at the rear part.
- Connection using wires up to 1.5mm².

For EasyPact CVS100BS		EasyPact CVS100BS	
		AC	DC
Consumption	Pick-up (MX)	< 10VA	< 10W
	Seal-in (MN, MNR)	< 5VA	< 5W
Response time (ms)		< 50	< 50

Note: 1. CVS100BS: select any two from three auxiliary switches (OF, SD, OF/SD).



EasyPact CVS100BS Voltage Release



EasyPact CVS100BS with a direct rotary handle

Rotary handle

Two types of rotary handle are available:

- Direct rotary handle
- Extended rotary handle

Direct rotary handle

Protection degree: IP40, IK07, IP54

Operation

- Function:
 - Suitability for isolation
 - Indications of three positions including O (OFF), I (ON) and Tripped
 - Access to "push-to-trip" button
- Circuit breaker locking capability in the OFF position by 1 to 3 padlocks, with a shackle diameter 5 to 8 mm (not supplied)

Installation

The front cover of the circuit breaker can be removed and replaced by the extended handle.

EasyPact CVS100BS series

The direct rotary handle is used in the following cases:

- Switchboards in motor control center (MCC):
 - Circuit-breaker closing is disabled if the door is open.
 - Door opening is disabled when the circuit breaker is ON.
 - Protection degree: IP43, IK07 (IP54, IK08)
 - Machine tool control, in compliance with CNOMO E03.81.501N, with a protection degree of IP54, IK08



EasyPact CVS100BS with an extended rotary handle

Extended rotary handle

The circuit breaker on the switch cabinet can be operated with the rotary handle on the front.

Protection degree: IP55, IK08, IP54

OperationFunctions:

- Suitability for isolation
 - Indications of three positions including O (OFF), I (ON) and Tripped
 - Access to trip unit settings, when the switchboard door is open.
- Circuit breaker closing is disabled if the door is open.
- Circuit breaker locking capability in the OFF position by 1 to 3 padlocks, with a shackle diameter 5 to 8 mm (not supplied). These are used to prevent the door from being opened.

The extended rotary handle is made up of:

- A unit that replaces the front cover of the circuit breaker ⁽¹⁾.
- An assembly (handle and front plate) on the door that is always secured in the same position, whether the circuit breaker is horizontally or vertically installed.
- An extension shaft that must be adjusted to the distance. The distance between the back of the circuit breaker and door is:
 - EasyPact CVS100BS: 145~422mm

Tripping Curve EasyPact CVS100BS

Power Distribution Protection System

16 A

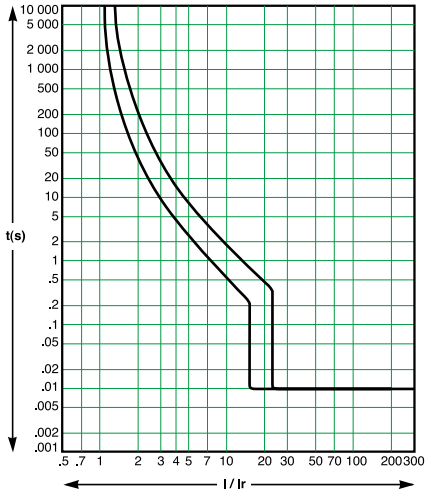

20 A

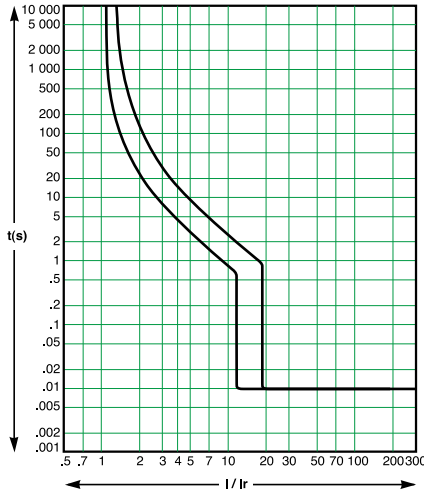

25 A

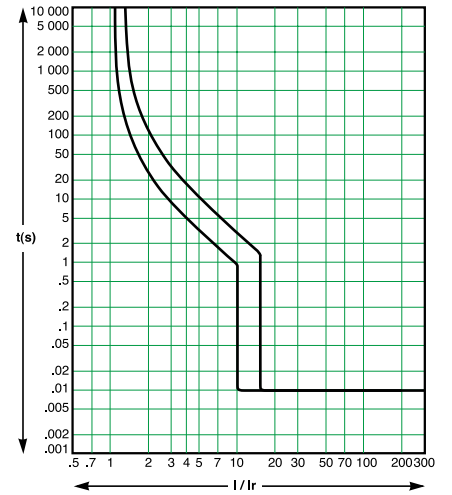

32 A

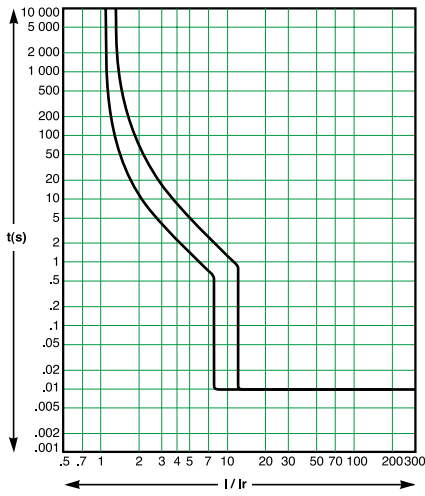

40 A

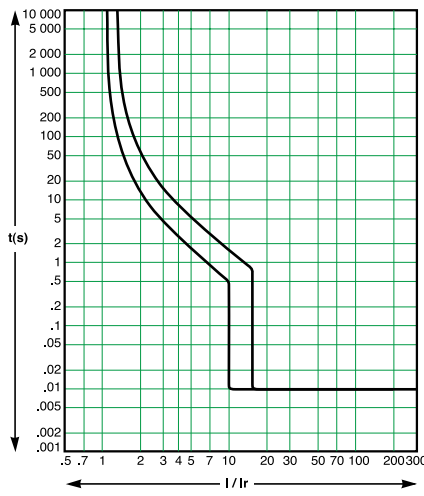

50 A

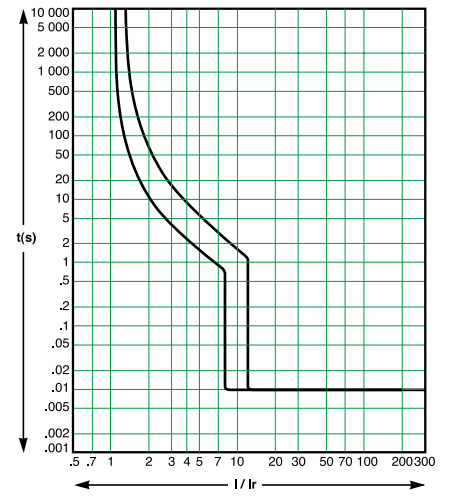

63 A

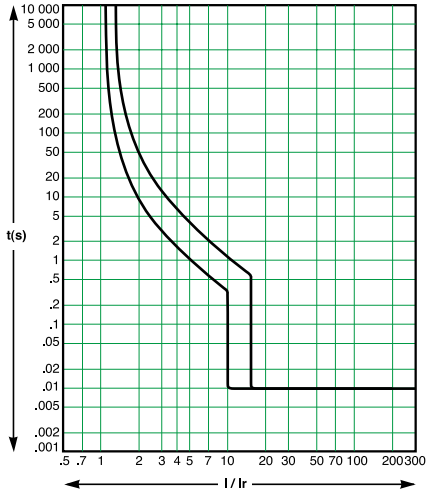

80 A

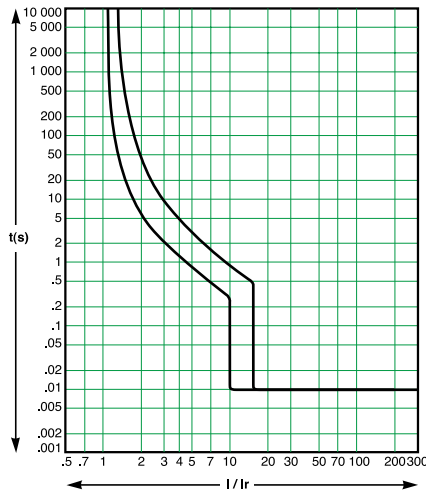

100 A

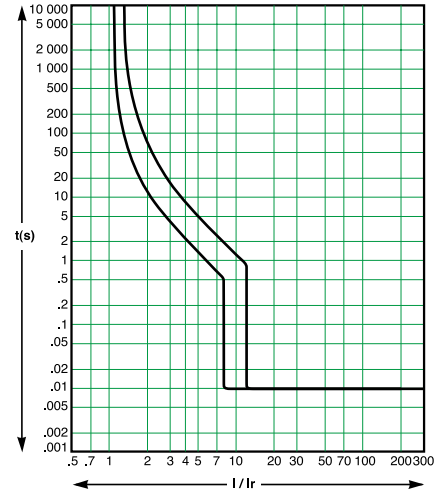

Temperature derating of trip units

EasyPact CVS100BS

Rating (A)	40°C	45°C	50°C	55°C	60°C	65°C	70°C
16	16.7	16.3	16.0	15.7	15.6	15.1	14.7
20	20.4	20.2	20.0	19.7	19.2	18.9	18.5
25	25.7	25.3	25.0	24.7	24.5	24.3	24.0
32	33.5	32.7	32.0	31.4	31.0	30.4	29.9
40	40.9	40.4	40.0	39.5	38.0	37.6	37.1
50	52.1	51.0	50.0	49.3	48.1	47.3	46.6
63	64.9	63.9	63.0	62.0	60.4	59.4	58.5
80	82.2	81.1	80.0	78.6	77.3	76.7	76.1
100	103.0	101.0	100.0	99.0	94.0	94.0	93.0

Altitude Derating of trip units

Altitude does not significantly affect circuit-breaker characteristics up to 2000 m. Above this altitude, it is necessary to take into account the decrease in the dielectric strength and cooling capacity of air. It should be noted that the breaking capacity remained unchanged.

EasyPact CVS100BS			
Height (m)	2000	2600	3900
Dielectric strength (V)	3000	2850	2400
Maximum operation voltage (V)	690	655.5	552
Nominal current at 40°C (A)	1 x I _n	0.95 x I _n	0.8 x I _n

Current-limiting capacity refers to the ability of a circuit breaker to limit short-circuit current.

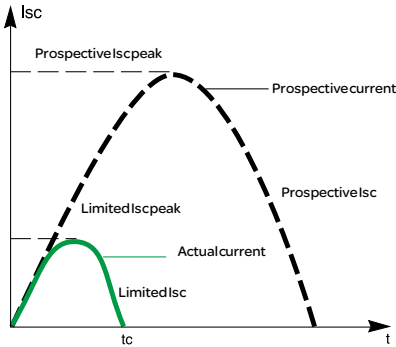

Ics 17kA

Current-limiting performance of EasyPact CVS100BS series helps lower power generated by fault current, and consequently improves the breaking capacity of the circuit-breaker. Ics 17kA.

Extension of service life of electrical installation

Circuit breaker current-limiting technology greatly reduces damage to installation caused by short-circuit current.

Thermal effect

lowers temperature rise and extend the service life of the cable.

Mechanical effect

Risks of contact and busbar distortion and damage are greatly reduced since the electrodynamic force is decreased.

Electromagnetic effect

Disturbance on surrounding measurement instrument is relieved.

Current-limiting curve

Current-limiting capacity of a circuit breaker can be represented by two curves. It varies with the value of prospective short-circuit current (short-circuit current without any protective device).

- Actual peak current (current-limiting)
- Thermal effect (A^2s), which means energy loss of a 1Ω conductor carrying the short-circuit current.

Maximum allowable thermal stress of cable

The maximum allowable overhear values (in A^2s), dependent on cable insulation material (Cu or Al) and cross-section (mm^2), are listed in the following table.

Cross section (mm^2)		1.5	2.5	4	6	10
PVC	Copper	2.97×10^4	8.26×10^4	2.12×10^5	4.76×10^5	1.32×10^6
	Aluminum	-	-	-	-	5.41×10^5
PRC	Copper	4.10×10^4	1.39×10^5	2.92×10^5	6.56×10^5	1.82×10^6
	Aluminum	-	-	-	-	7.52×10^5
Cross section (mm^2)		16	25	35	50	
PVC	Copper	3.4×10^6	8.26×10^6	1.62×10^7	3.31×10^7	
	Aluminum	1.39×10^6	3.38×10^6	6.64×10^6	1.35×10^7	
PRC	Copper	4.69×10^6	1.39×10^7	2.23×10^7	4.56×10^7	
	Aluminum	1.93×10^6	4.70×10^6	9.23×10^6	1.88×10^7	

Current-limiting curves of EasyPact CVS100BS

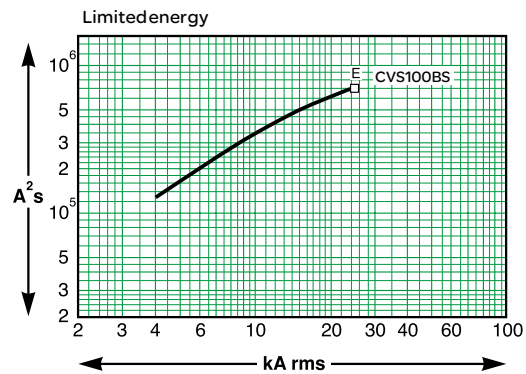
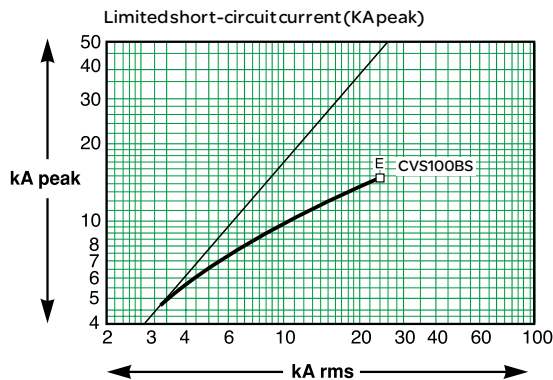



EasyPact CVS100BS

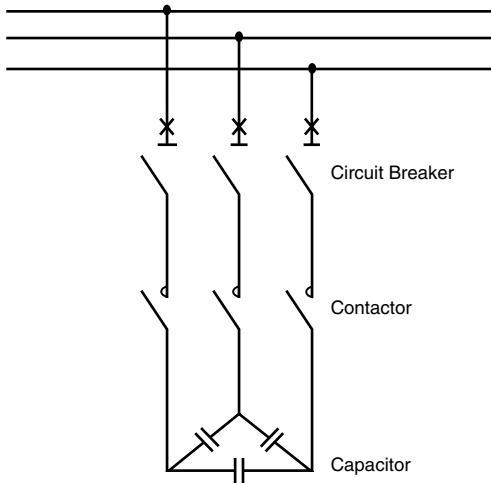

EasyPact CVS100BS circuit breaker is suitable for capacitor protection following the rules below:

■ **Inc = Nominal current of the capacitor**

$$I_{nc} = \frac{Q_c}{U\sqrt{3}}$$

I_{nc} = Nominal Current Capacitor (A)
 Q_c = Reactive power (kVAR)
 U = Nominal Voltage (V)

■ **Inb = Nominal current of the circuit breaker**

- $I_{nb} = 1.36 \times I_{nc}$ for standard equipment
- $I_{nb} = 1.5 \times I_{nc}$ for overrated type equipment
- $I_{nb} = 1.12 \times I_{nc}$ for detuned type equipment: 2.7 tuning
- $I_{nb} = 1.19 \times I_{nc}$ for detuned type equipment: 3.8 tuning
- $I_{nb} = 1.31 \times I_{nc}$ for detuned type equipment: 4.3 tuning
- the short-circuit (magnetic) protection-setting thresholds must enable passage of the energising transients: $10 \times I_{nc}$ for standard, overrated and detuned type equipment.

■ **Icu = Ultimate breaking capacity of the circuit breaker**

I_{cu} short-circuit level is given by the installation.

Example:

Table at 400 V AC - 3 phases 50 Hz for standard equipment.

Reactive power (kVAR)	I_{nc} (A)	I_{nb} (A)	Breaking capacity to Circuit Breaker 30 kA
7.5	11	16	LV510930
10	14	20	LV510931
15	22	30	LV510933
20	29	40	LV510934
30	43	60	LV510936
40	58	80	LV510937
50	72	100	LV510938

EasyPact CVS100BS

With TM-D thermal magnetic trip unit

EasyPact CVS100BS (25 kA at 380/415 V)

Rating	3P3d	4P3d
TM16D	LV510930	
TM20D	LV510931	
TM25D	LV510932	LV510952
TM32D	LV510933	LV510953
TM40D	LV510934	LV510954
TM50D	LV510935	LV510955
TM63D	LV510936	LV510956
TM80D	LV510937	LV510957
TM100D	LV510938	LV510958

Connection accessories

Cable lugs

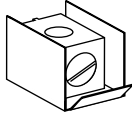

≤50A

Cables from 2.5 to 16 mm²

Set of 2

EZALUG0502

Set of 3

EZALUG0503

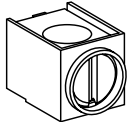

> 50A

Cables from 10 to 50 mm²
24V

Set of 2

EZALUG1002

Set of 3

EZALUG1003

Spreaders

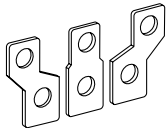

Spreaders for 3P breaker

Set of 3

EZASPDR3P

Spreaders for 4P breaker

Set of 4

EZASPDR4P

Terminal shields

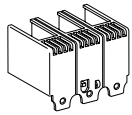

Terminal shields for 3P breaker

Set of 2

EZATSHD3P

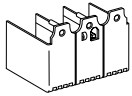

Terminal shields for 4P breaker

Set of 2

EZATSHD4P

Phase barriers

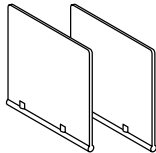

Phase barriers

Set of 2

EZAFASB2

Electrical auxiliaries

Indication contacts

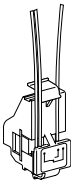

Auxiliary switch (AX)

EZAUX10



Alarm switch (AL)

EZAUX01



Auxiliary switch + alarm switch (AX + AL)

EZAUX11

Electrical auxiliaries(Cont.)

Voltage releases

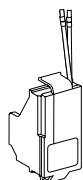

	Voltage	MX/SHT
AC	100-130V	EZASHT100AC
	200-277V	EZASHT200AC
	380-480V	EZASHT380AC
DC	24V	EZASHT024DC

Shunt trip(SHT)

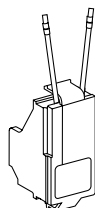

	Voltage	MN/UVR
AC	110-130V	EZAUVR200AC

Undervoltage release(UVR)

Rotary handles

Direct rotary handle (for 3/4P breaker)

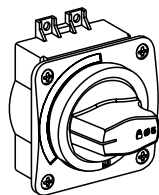

Direct rotary handle(black)	EZAROTDS
------------------------------	----------

Extended rotary handle (for 3/4P breaker)

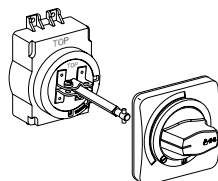

Extended rotary handle(black)	EZAROTE
--------------------------------	---------

Locks

Padlocking system

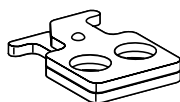

Padlocking system	EZALOCK
-------------------	---------

Installation accessory

DIN rail adaptor

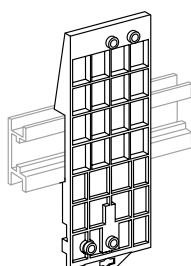

For 2 x 1P or 1 x 2P or 1 x 3P breaker	EZADINR
Note: for 4P breaker, use 2 adaptors	

Dimensions

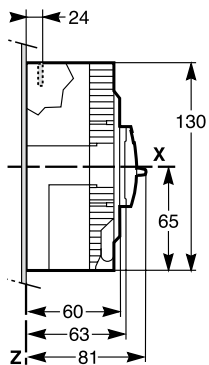

3P

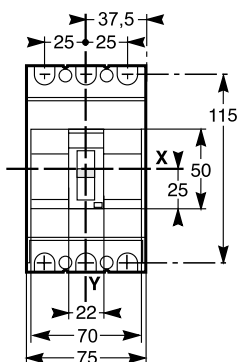

4P

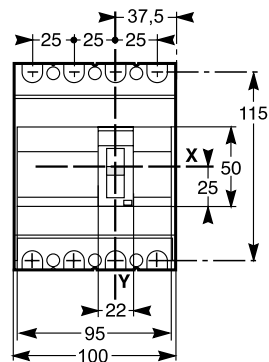

Backplate mounting

3P

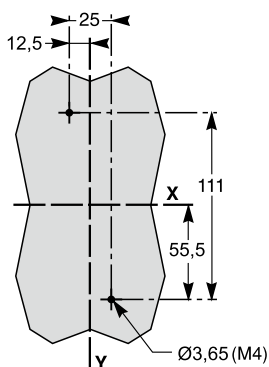

4P

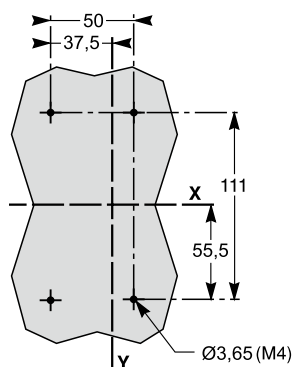

DIN rail mounting

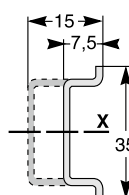
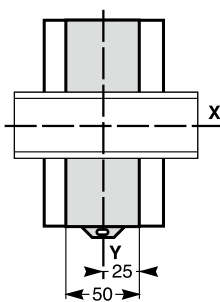
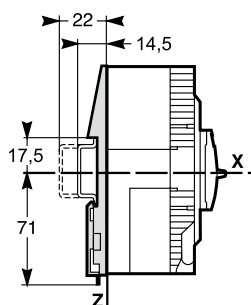

Front panel cutout (small)

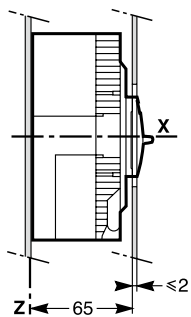

3P

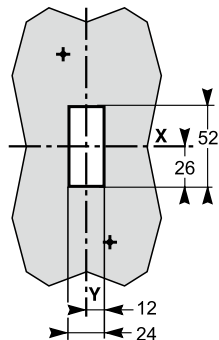

4P

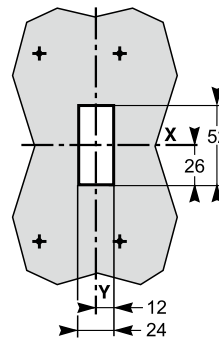

Front panel cutout (large)

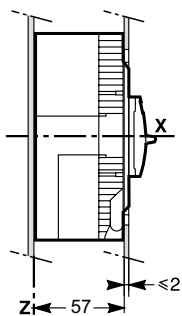

3P

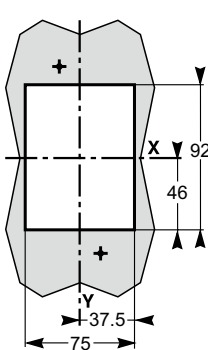

4P

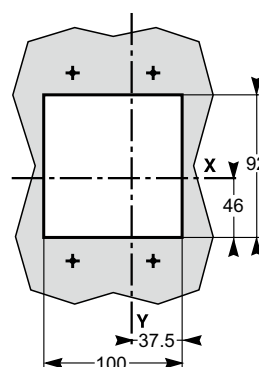

Terminal shield

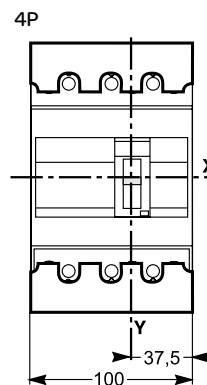
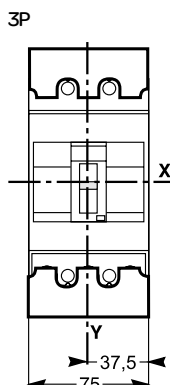
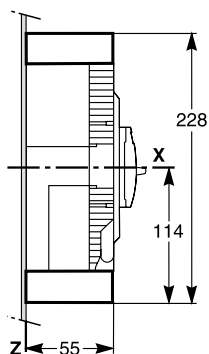

Interphase barrier

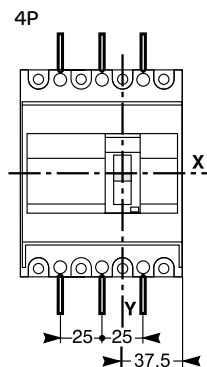
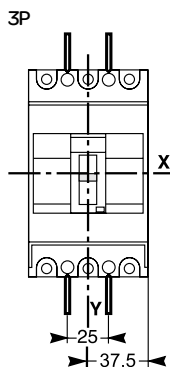
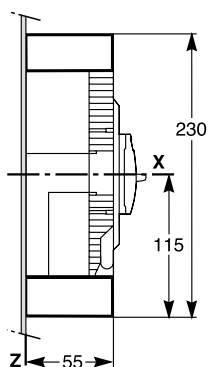

Direct rotary handle

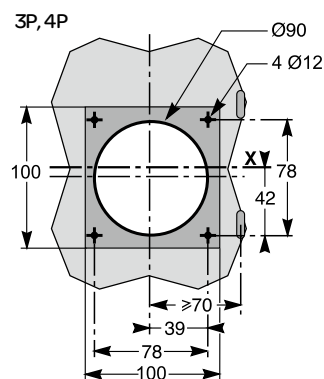
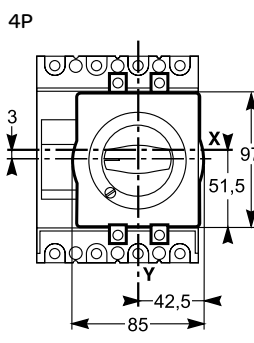
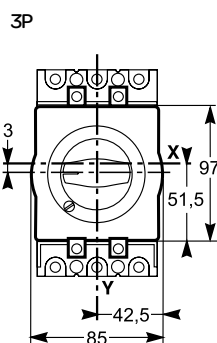
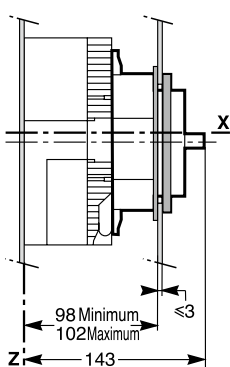

Extended rotary handle

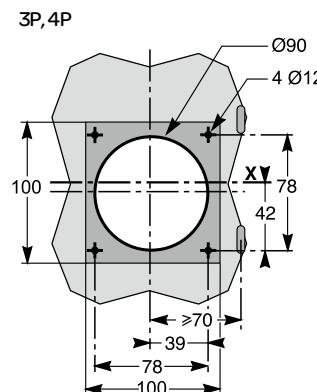
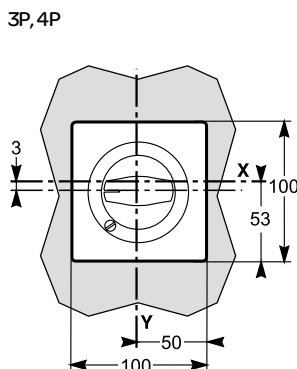
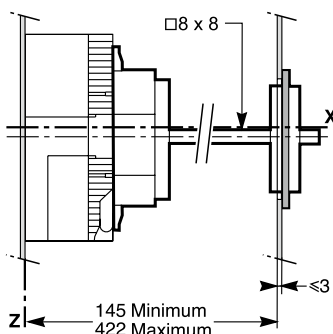

Life Is On



Schneider Electric Industries SAS

35, rue Joseph Monier
CS 30323
92506 Rueil Malmaison Cedex
France

RCS Nanterre 954 503 439
Capital social 928 298 512 €
www.se.com

Aug-2020

© 2019 - Schneider Electric. All Rights Reserved.
All trademarks are owned by Schneider Electric Industries SAS or its affiliated companies.
Document reference LVED210011EN

This document has been
printed on recycled paper

