

## APLIQUE – PLAFÓN – PIE DE SALÓN – SOBREMESA - COLGANTE

La tela elástica adquiere una forma facetada recubriendo las líneas limpias que forman su estructura metálica, permite realizar composiciones que envuelven la estancia en un ambiente estelar. Es adaptable a todo tipo de paredes y techos. Se pueden combinar de diferentes tamaños y crear una sensación de intensa y sugerente claridad.

### WALL BRACKET - SURFACE LIGHT - FLOOR LAMP - TABLE LAMP – SUSPENSION

Play and design with stars, with different surface compositions suitable for any kind of ceiling, wall or sloping ceilings. Range including also suspension, floor & table lamps. You may combine different POLARIS, different sizes and shapes. Removable stretching fabric covering a metal frame.

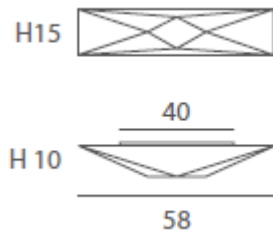

REF.  
20007/00

APLIQUE / WALL BRACKET  
IP20

MATERIAL  
Metal y tela elástica /  
Metal & stretching fabric

ACABADO / FINISH  
Blanco óptico / Optical white

INSTALACIÓN / INSTALLATION  
- E27 LED 2x10W Ø6cm 

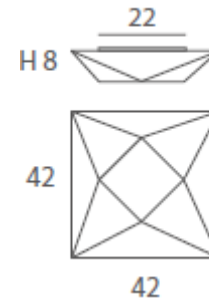

REF.  
20007/42

PLAFÓN / SURFACE LIGHT  
IP20

MATERIAL  
Metal y tela elástica /  
Metal & stretching fabric

ACABADO / FINISH  
Blanco óptico / Optical white

INSTALACIÓN / INSTALLATION  
- E27 LED 2x10W Ø6cm 

- PCB-LED 20W 700mA  
Cálida / Warm 3000K 1180lm  
Neutra / Neutral 4000K 1235lm



\*(bombillas no incluidas / lamps not included)

Ⓥ dim 1-10V

Ⓞ dim DALI

Ⓟ dim PUSH

Ⓡ REMOTE

\* Archivos 3D y ficheros fotométricos disponibles en web / 3D and photometric files available on the web

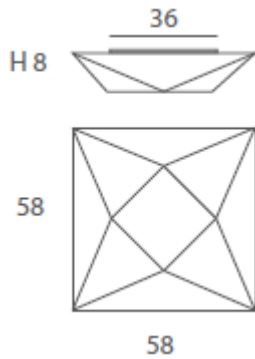





REF.  
20007/58



PLAFÓN / *SURFACE LIGHT*  
IP20

MATERIAL  
Metal y tela elástica /  
*Metal & stretching fabric*

ACABADO / *FINISH*  
Blanco óptico / *Optical white*

INSTALACIÓN / *INSTALLATION*  
- E27 LED 4x10W Ø6cm 

- PCB-LED 40W 700mA     
Cálida / *Warm 3000K 2400lm*  
Neutra / *Neutral 4000K 2510lm*

-PCB-LED 55W 500mA    
Cálida / *Warm 3000K 3115lm*  
Neutra / *Neutral 4000K 3258lm*

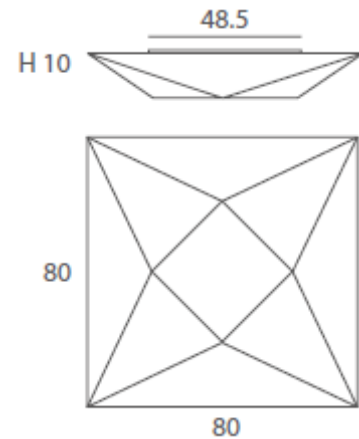





REF.  
20007/80



PLAFÓN / *SURFACE LIGHT*  
IP20



MATERIAL  
Metal y tela elástica /  
*Metal & stretching fabric*

ACABADO / *FINISH*  
Blanco óptico / *Optical white*

INSTALACIÓN / *INSTALLATION*  
- E27 LED 4x10W Ø6cm 

- PCB-LED 40W 700mA     
Cálida / *Warm 3000K 2400lm*  
Neutra / *Neutral 4000K 2510lm*

-PCB-LED 70W 500mA     
Cálida / *Warm 3000K 4492lm*  
Neutra / *Neutral 4000K 4698lm*

-PCB-LED 72W 300mA    
Regulable en temp./ brillo  
*Dimmable temp./ brightness*  
3000K - 6000K max.3632lm



\*(bombillas no incluidas / *lamps not included*)

 dim 1-10V     dim DALI     dim PUSH     REMOTE

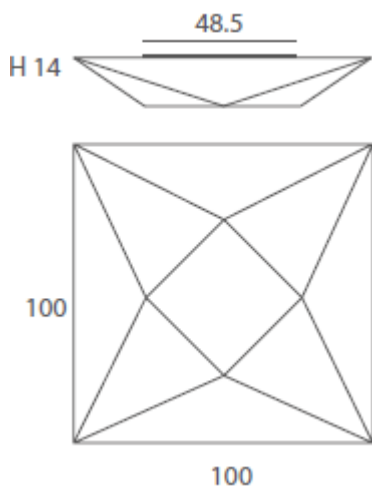





REF.  
20007/100



PLAFÓN / *SURFACE LIGHT*  
IP20

MATERIAL  
Metal y tela elástica /  
*Metal & stretching fabric*

ACABADO / *FINISH*  
Blanco óptico / *Optical white*

INSTALACIÓN / *INSTALLATION*  
- E27 LED 5x10W Ø6cm 

- PCB-LED 40W 700mA     
Cálida / *Warm 3000K 2400lm*  
Neutra / *Neutral 4000K 2510lm*

-PCB-LED 70W 500mA     
Cálida / *Warm 3000K 4492lm*  
Neutra / *Neutral 4000K 4698lm*

-PCB-LED 72W 300mA   
Regulable en temp./ brillo  
*Dimmable temp./ brightness*  
3000K - 6000K max.3632lm

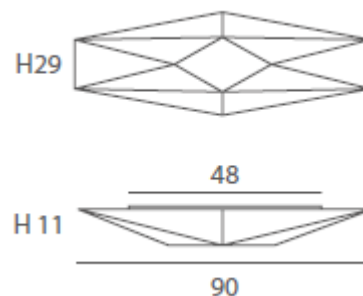

REF.  
20016/R90

PLAFÓN-APLIQUE / *SURFACE LIGHT*  
IP20

MATERIAL  
Metal y tela elástica /  
*Metal & stretching fabric*

ACABADO / *FINISH*  
Blanco óptico / *Optical white*

INSTALACIÓN / *INSTALLATION*  
- E27 LED 2x10W Ø6cm 

- PCB-LED 20W 700mA  
Cálida / *Warm 3000K 1180lm*  
Neutra / *Neutral 4000K 1235lm*



\*(bombillas no incluidas / *lamps not included*)

 dim 1-10V  dim DALI  dim PUSH  REMOTE

\* Archivos 3D y ficheros fotométricos disponibles en web / *3D and photometric files available on the web*

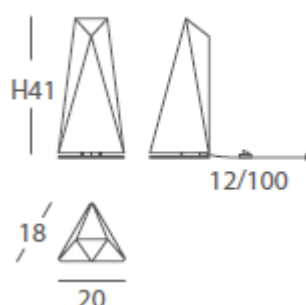

REF.  
23000

PIE DE SALÓN / FLOOR LAMP  
IP20

MATERIAL  
Metal y tela elástica /  
*Metal & stretching fabric*

ACABADO / FINISH  
Blanco óptico / *Optical white*

INSTALACIÓN / INSTALLATION  
- G5 1x35W  T5



Bombilla incluida

REF.  
23001

SOBREMESA / TABLE LAMP  
IP20

MATERIAL  
Metal y tela elástica /  
*Metal & stretching fabric*

ACABADO / FINISH  
Blanco óptico / *Optical white*

INSTALACIÓN / INSTALLATION  
- E27 LED 1x10W Ø6cm 



REF.  
80015/80

COLGANTE / *SUSPENSION*  
IP20

MATERIAL  
Metal, tela elástica y metacrilato /  
*Metal, stretching fabric & PMMA*

ACABADO / *FINISH*  
Florón níquel satinado /  
*Satin nickel canopy*  
Tela blanco óptico /  
*Optical white fabric*  
Metacrilato opal (tapa superior) /  
*Opal PMMA (top cover)*

INSTALACIÓN / *INSTALLATION*  
- E27 LED 4x10W Ø6cm 

**A++ A**

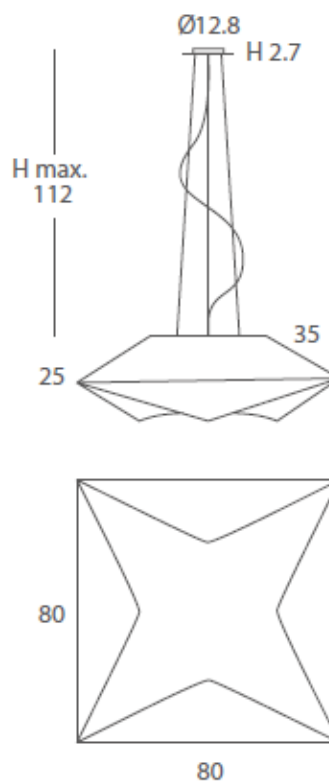

## DOBLE ENCENDIDO

---

**MODELOS DISPONIBLES CON DOBLE ENCENDIDO (en la instalación PCB-LED 40W) :**

*MODELS AVAILABLE FOR 2 SWITCHES (For installation PCB-LED 40W ):*

**20007/58, 20007/80, 20007/100**

40W



20W



20W

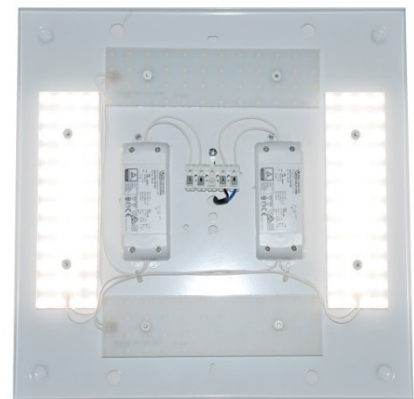

El aparato se suministra  
así desde fábrica

*This is the standard switch  
configuration supplied  
from factory if there is not  
2-switch request in your  
order*



Teniendo en la instalación dos llaves, se  
puede pedir desde fábrica con dos  
encendidos

*If installation has possibility of 2  
switches, we may supply as per above 2-  
switch configuration, on request*