

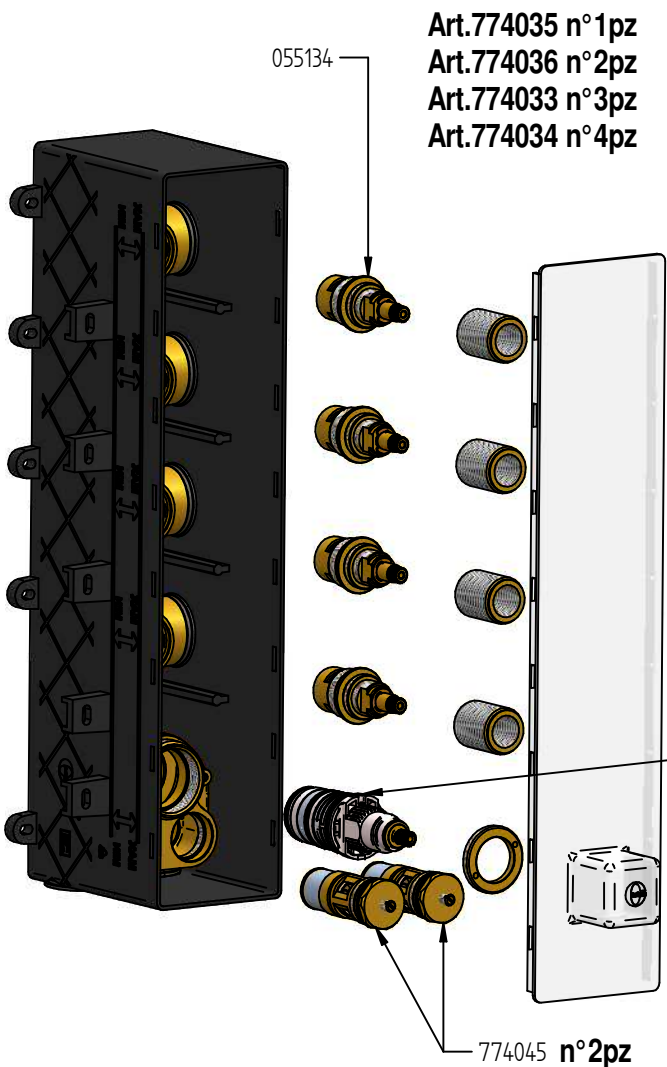

RICAMBI / SPARE PARTS

ISTRUZIONI revivre



COD. 055134



COD. 774045



COD. 775007

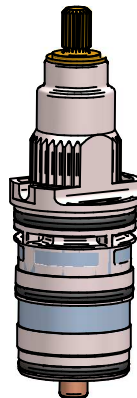

La BELLOSTA CARLO & C. non è RESPONSABILE di danni derivati dall'utilizzo di prodotti impropri per la pulizia.
BELLOSTA CARLO & C. cannot be held responsible for damages due to an improper use of detergents

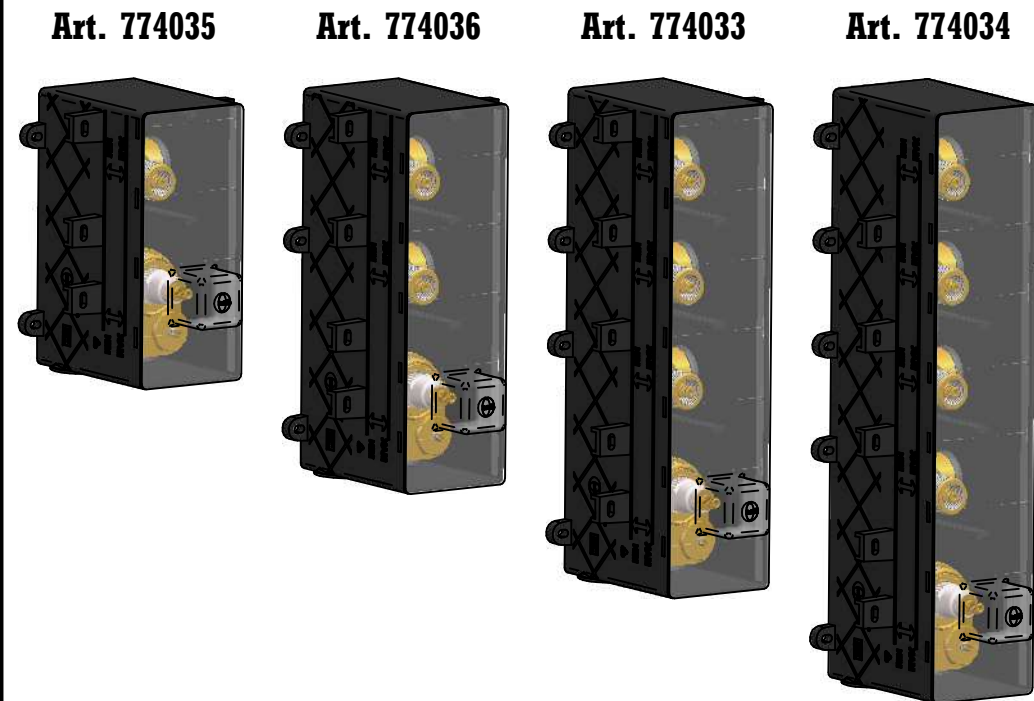

1



SPURGARE IMPIANTO



2

SCOSTAMENTO CONSIDERATO A MURO FINITO COMPRESO DI RIVESTIMENTO

LIMIT MEASURE AT ENDED WALL INCLUSIVE OF COVERING

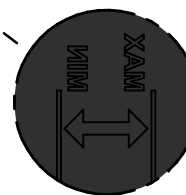
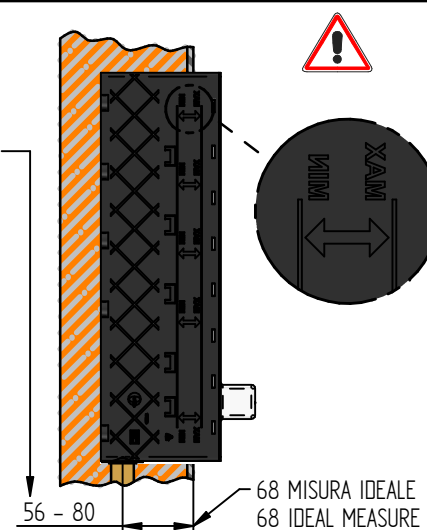

DA CONSERVARE

OPERATORE CONTROLLO FILETTI

Timbro:

ufficio tecnico BELLOSTA
C.A. 03/18 ISO 9001:2015



D

MADE IN ITALY

Questo prodotto è stato realizzato interamente in Italia con l'utilizzo di materie prime di altissima qualità

DESIGN
EOB

MADE IN ITALY

This product has been entirely manufactured in Italy, by top quality raw materials.



Rubinetti d'autore dedicati a te

3

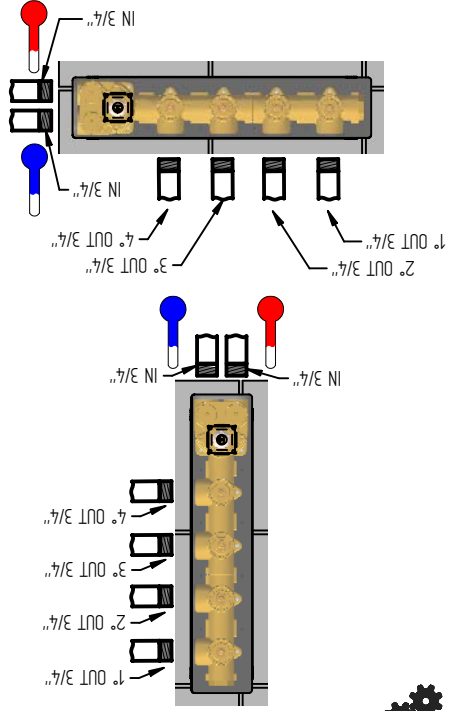

4

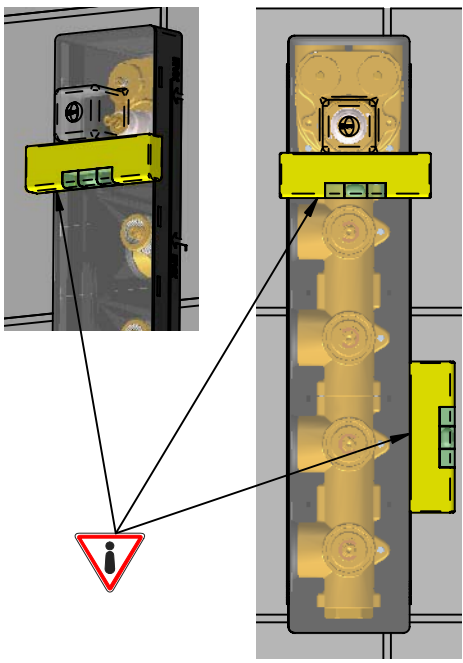

6

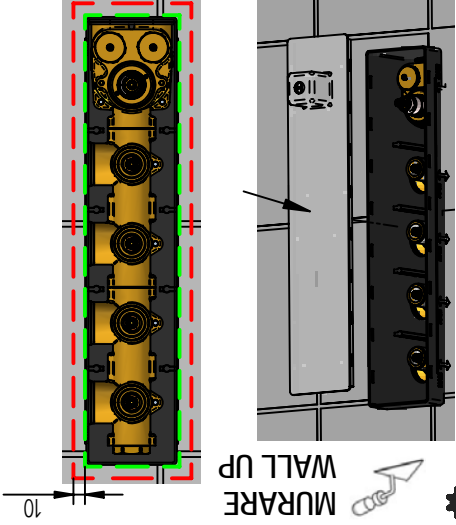

Art.774035 100x210
Art.774036 100x280
Art.774033 100x350
Art.774034 100x420

5

VERIFICA IMPIANTO

PLANT CHECK

OPEN / CLOSE

1
2
3
4

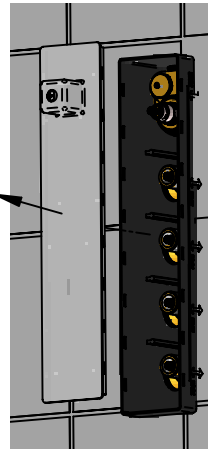

6

Dimensioni piastra Wall plate dimensions

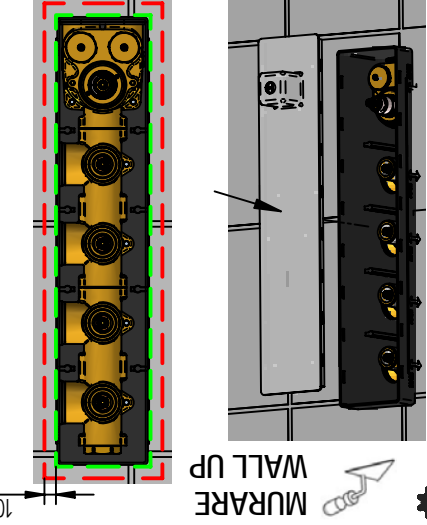

Art.774035 100x210
Art.774036 100x280
Art.774033 100x350
Art.774034 100x420

1

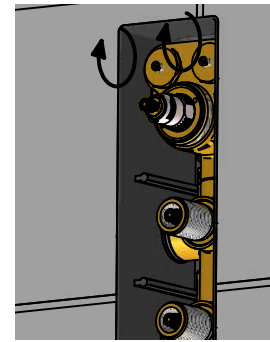
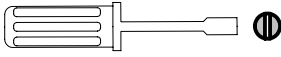

CLOSE

1
2

2

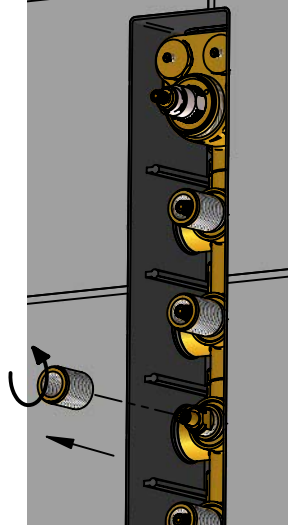

3

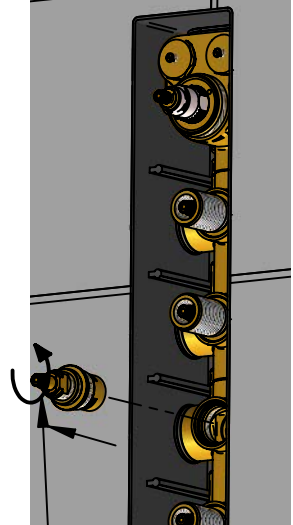

SOSTITUZIONE VITONE ART. 055034
RIGHT CERAMIC VALVE REPLACEMENT ART. 055034

CH 14 mm

1

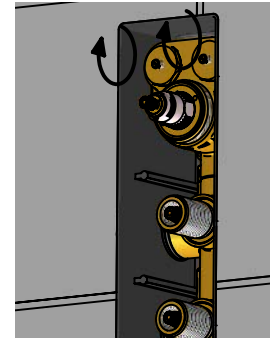
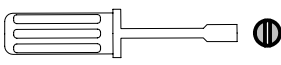

CLOSE

1
2

2

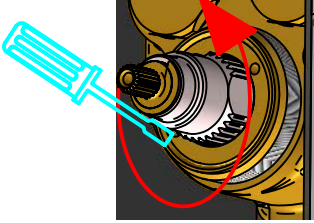

3

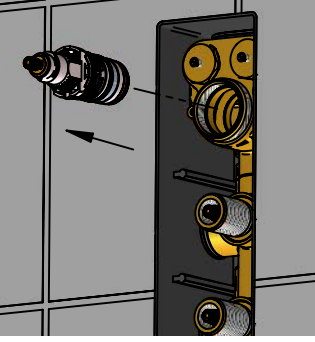

SOSTITUZIONE CARTUCCIA ART. 775007
THERMOSTATIC VALVE REPLACEMENT ART. 775007

3