

OsiSense XCC

PROFIBUS-DP Multi-Turn Absolute Encoder

User's Manual

Version

04/2011

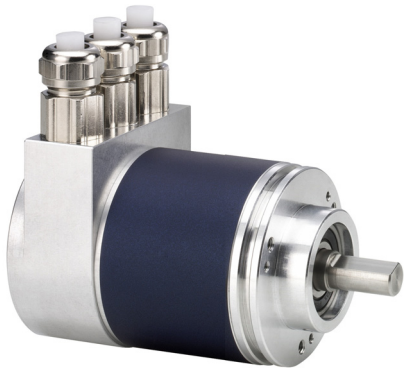

© 2011 Schneider Electric. All rights reserved.

Table of Contents



	Safety Information	5
	About the Book	7
Chapter 1	Introduction	9
	Introduction	10
	General Presentation	12
Chapter 2	Installation	15
	Connection Base	16
	Wiring the Bus and the Power Supply	18
	Wiring the Encoder	20
	Accessories	21
	Installation Precautions	22
Chapter 3	Characteristics	25
	Encoder Characteristics	25
Chapter 4	Configuration	27
	Encoder Configuration	28
	Software Configuration	30
	SyCon Configuration Tool	31
Chapter 5	Functions	37
	Description of the Encoder Profile	38
	Description of Functions	40
	Data Exchange	47
	Commissioning Mode	48
Chapter 6	Diagnostics	53
	Diagnostic Messages	54
	Status Indication Provided by the LEDs in the Base	57
	FAQ	59
Glossary	61
Index	65

Safety Information

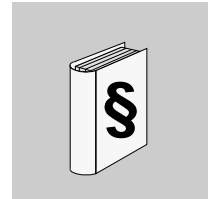

Important Information

NOTICE

Read these instructions carefully, and look at the equipment to become familiar with the device before trying to install, operate, or maintain it. The following special messages may appear throughout this documentation or on the equipment to warn of potential hazards or to call attention to information that clarifies or simplifies a procedure.



The addition of this symbol to a Danger or Warning safety label indicates that an electrical hazard exists, which will result in personal injury if the instructions are not followed.



This is the safety alert symbol. It is used to alert you to potential personal injury hazards. Obey all safety messages that follow this symbol to avoid possible injury or death.

DANGER

DANGER indicates an imminently hazardous situation which, if not avoided, **will result in** death or serious injury.

WARNING

WARNING indicates a potentially hazardous situation which, if not avoided, **can result in** death or serious injury.

 **CAUTION**

CAUTION indicates a potentially hazardous situation which, if not avoided, **can result in** minor or moderate injury.

CAUTION

CAUTION, used without the safety alert symbol, indicates a potentially hazardous situation which, if not avoided, **can result in** equipment damage.

PLEASE NOTE

Electrical equipment should be installed, operated, serviced, and maintained only by qualified personnel. No responsibility is assumed by Schneider Electric for any consequences arising out of the use of this material.

A qualified person is one who has skills and knowledge related to the construction and operation of electrical equipment and its installation, and has received safety training to recognize and avoid the hazards involved.

About the Book

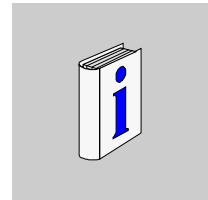

At a Glance

Document Scope

This manual explains how to install and configure the absolute rotary encoder with PROFIBUS-DP interface connected on a bus.

Related Documents

Title of Documentation	Reference Number
Instruction sheet	W9 1690021

You can download these technical publications and other technical information from our website at www.schneider-electric.com.

User Comments

We welcome your comments about this document. You can reach us by e-mail at techcomm@schneider-electric.com.

Introduction



Overview

The purpose of this section is to provide general information about the encoder described in this documentation.

References of the PROFIBUS-DP encoders:

Description	Reference
PROFIBUS-DP encoder with a solid shaft	XCC 3510PV84FBN
PROFIBUS-DP encoder with a hollow shaft	XCC 3515CV84FBN

What's in this Chapter?

This chapter contains the following topics:

Topic	Page
Introduction	10
General Presentation	12

Introduction

Principle

This manual explains how to install and configure the absolute rotary encoder with PROFIBUS-DP interface.

Multi-Turn Absolute Rotary Encoder

Multi-turn absolute rotary encoders identify any moving point by means of a single digital signal. Due to their ability to give a single, exact position to all linear and angular positions, absolute rotary encoders have become one of the most important links between the mechanical system and the control system.

The basic principle behind an absolute rotary encoder is the optical sampling of a transparent disk fixed on the rotating shaft.

Resolution:

Type	Value	No. of bits
Maximum no. of steps per revolution	8192	13
Maximum no. of detectable revolutions	4096	12
Maximum resolution (no. of steps)	33554432	25

The encoder casing provides access to two rotary switches for configuring the address. It also incorporates two LEDs that assist diagnostics. The encoder acts as a T with two PG9s for the Bus In and Bus Out signals.

The encoders comply with international standards IEC61158 and IEC61784 for PROFIBUS-DP communication and the PROFIBUS-DP standard EN50170 CLASS 2 according to encoder profile 3.062 version 1.1 for the encoder application. They are certified by the PNO organization and satisfy Schneider-Electric's interoperability standards.

The encoder configuration GSD file can be downloaded from "www.schneider-electric.com".

General PROFIBUS Information

PROFIBUS is an open and non-proprietary international standard relating to fieldbuses, defined in international standards EN 50170 and EN 50254. It is available in three versions: PROFIBUS-DP, PROFIBUS-FMS and PROFIBUS-PA. The Telemecanique absolute encoder is designed for the DP version. It supports all standard data transmission speeds up to 12 MBauds.

NOTE: More extensive information on the PROFIBUS technology (functionality, manufacturer, products), encoder standards and profiles are available from PNO:

PROFIBUS Nutzerorganisation (PNO)

Haid-und-Neu-Straße 7

D-76131 Karlsruhe

Tel: ++49 (0) 721 / 96 58 590

Fax: ++49 (0) 721 / 96 58 589

www.profibus.com

General Presentation

Description

The absolute rotary encoder with PROFIBUS-DP interface looks like this:

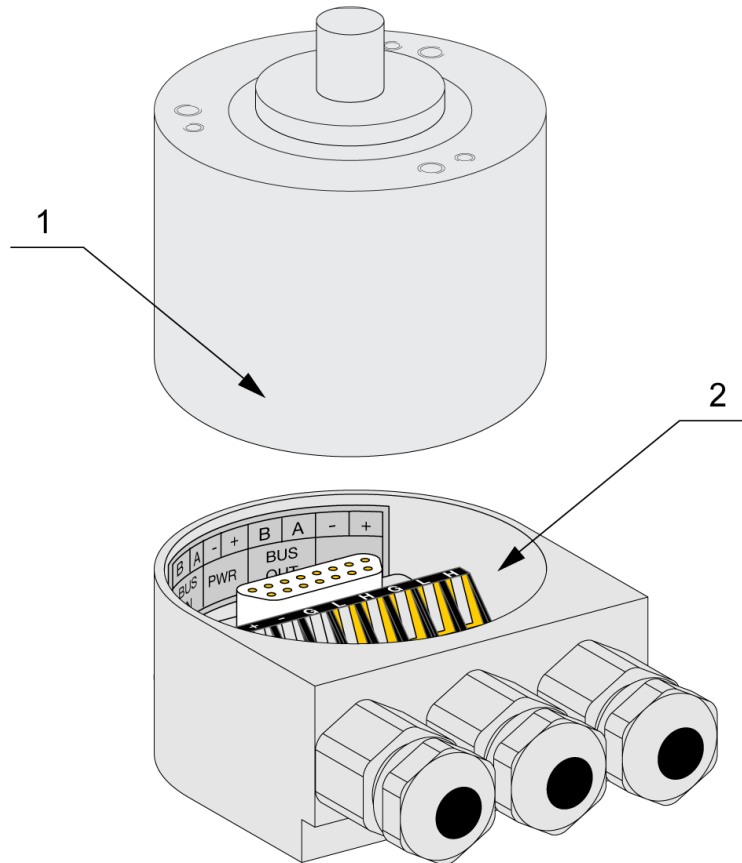

Encoder elements:

No.	Description
1	Encoder body
2	Connection base

The encoder body connects to the base via a 15-pin SUB-D connector.

Networking

The absolute rotary encoder interface is based on the PROFIBUS-DP standard (standard EN 50170). In order to be able to use the encoder as a slave with the PROFIBUS-DP interface, an interface card is required in the control system which acts as a PROFIBUS master.

The power to the encoders is supplied directly via the central PG9 of each encoder.

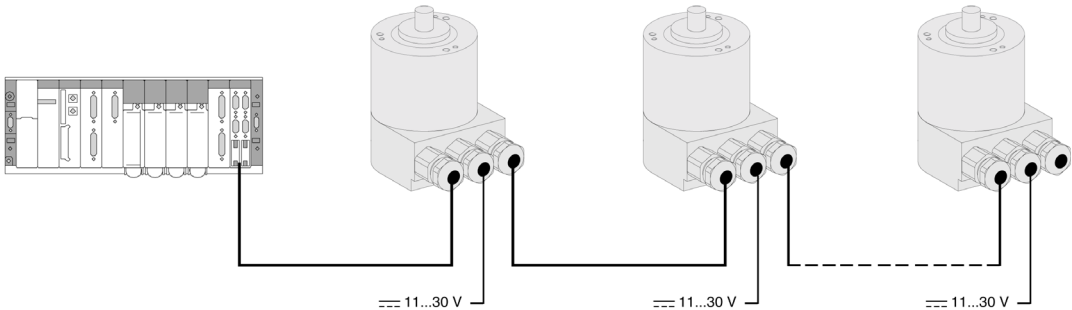

Bus Architecture

The maximum number of stations on PROFIBUS is 126. The encoder can be addressed from 0 to 99.

The maximum number of nodes per segment (including repeaters) is 32 (a bus is divided into segments via repeaters).

Between 2 nodes, there are 4 repeaters maximum.

The available transmission speeds are: 9.6, 19.2, 45.45, 93.75, 187.5, 500, 1500, 3000, 6000, 12000 kBaud

⚠ CAUTION

UNINTENDED EQUIPMENT OPERATION

- Warranty invalidated if dismantled.
- Handle with care.
- In environments subject to interference, it is advisable to connect the encoder to ground, using one of the fixing screws.

Failure to follow these instructions can result in injury or equipment damage.

Installation

2

Overview

The absolute encoder is connected to a connection base by means of a 15-pin SUB-D connector. The base can be removed from the encoder (encoder without supply) by undoing two screws located on the side of the base. The bus and the electrical supply are routed into the base with PG9 cable glands and are connected to the terminal blocks.

What's in this Chapter?

This chapter contains the following topics:

Topic	Page
Connection Base	16
Wiring the Bus and the Power Supply	18
Wiring the Encoder	20
Accessories	21
Installation Precautions	22

Connection Base

Description

Unscrew the encoder base to access the encoder settings:

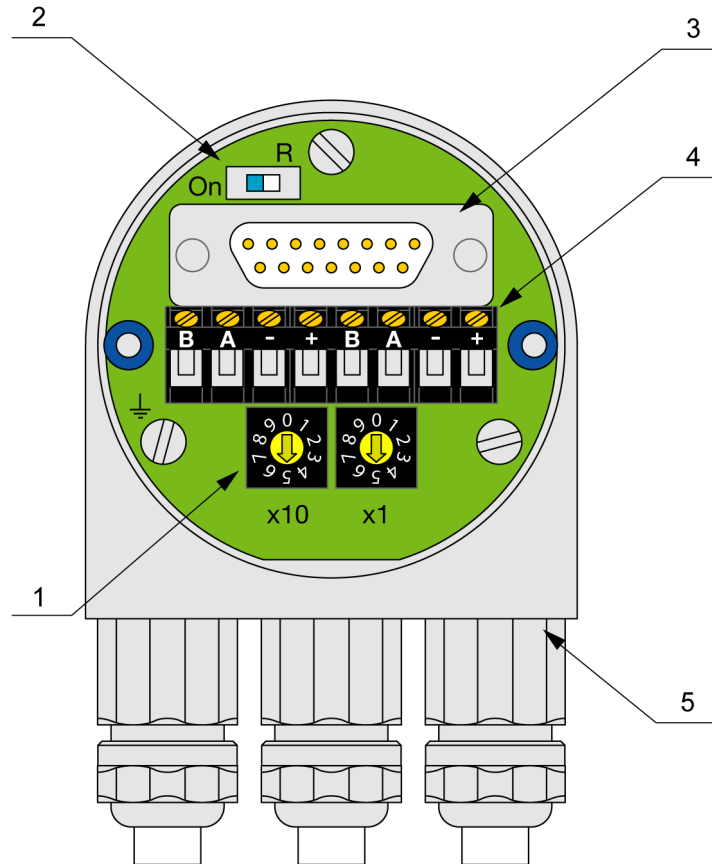

Elements that can be accessed in the base:

No.	Description	Application
1	Rotary switches	Encoder network address
2	Switch	Enables the line terminator
3	15-pin SUB-D	Base/encoder connection
4	Terminal block	Bus IN, Bus OUT and power supply
5	3 PG9 cable glands	Cable/base connection (for 24 VDC power supply cable, \varnothing 4...8 mm)

⚠ DANGER

RISK OF ELECTROCUTION

- Switch off the power supply before working on this device.
- Check that the rotating machine is immobilized before working on this device.
- Close the cover correctly after configuration or wiring the microswitch.

Failure to follow these instructions will result in death or serious injury.

Encoder Address

The rotary switches located in the base are used to set the encoder network address (node):

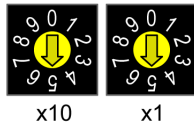

The switch marked (x1) is used to set the units and the switch marked (x10) is used to set the tens. The possible addresses are between 0 and 99, and any one address can only be used once in the network. The change of address is taken into account after a restart.

Line Terminator

If the encoder is connected at one end of the bus line, the line terminator must be enabled (set the switch to the "ON" position).

Encoder location on the bus	Switch position
Encoder in the middle of the bus	
Encoder at the end of the bus	

NOTE: If the terminator is set to "ON", the "Bus Out" terminals shall be disconnected (see *Wiring the Bus and the Power Supply, page 18*).

The base must be connected to the encoder for the bus to be wired correctly. If it is necessary to change the encoder during operation, a separate line terminator must be used.

Wiring the Bus and the Power Supply

Description

With the power off, remove the base to access the encoder wiring:

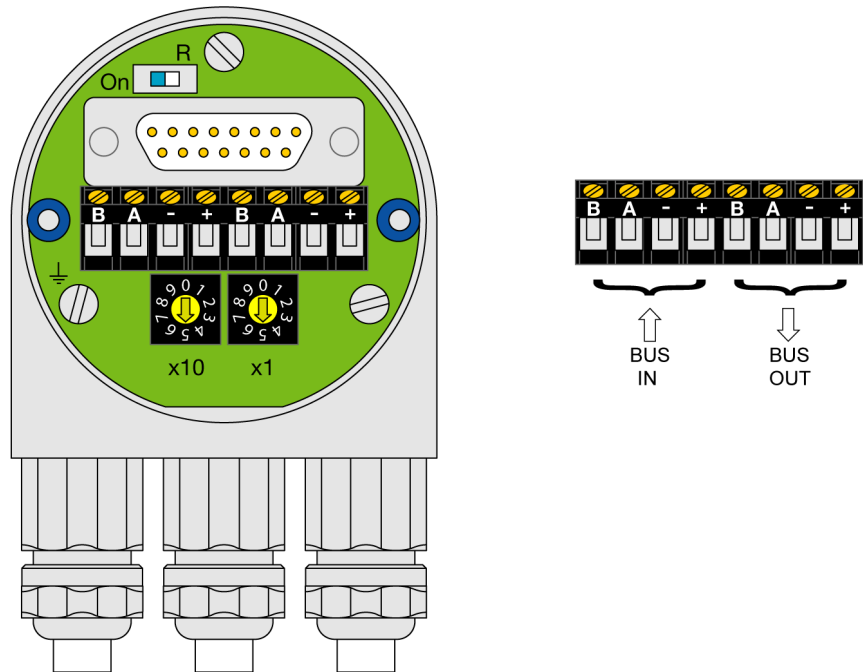

Description of the terminal block:

Terminal block	Terminal	Description
Bus In	B	B bus line
	A	A bus line
	-	0 V
	+	--- 11...30 V
Bus Out	B	B bus line
	A	A bus line
	-	0 V
	+	--- 11...30 V

The electrical supply must be connected to the "Bus In" terminal block.

NOTE: If the terminator is set to "ON", the "Bus Out" terminals are disconnected.

 **DANGER**

RISK OF ELECTROCUTION

- Switch off the power supply before working on this device.
- Check that the rotating machine is immobilized before working on this device.
- Close the cover correctly after configuration or wiring the microswitch.

Failure to follow these instructions will result in death or serious injury.

Wiring the Encoder

Connecting the Connection Base

To connect the connection base, proceed as follows:

Step	Action
1	Remove the screw, the seal gasket and the cable gland collar.
2	Prepare the cable as shown in the diagram below.
3	Place the screw and the seal gasket on the cable.
4	Fit the collar under the shielding.
5	Insert the cable assembly in the cable gland and tighten the screw.



Wiring diagram:

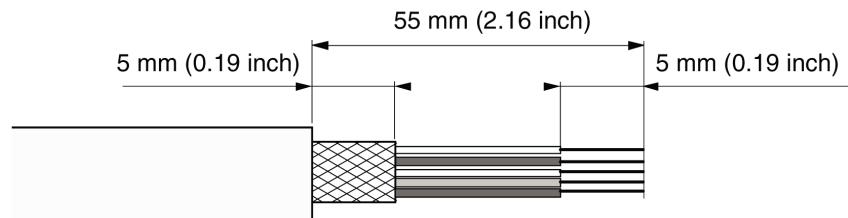

NOTE: Shielded cables should be used for data transmission to avoid problems with electromagnetic interference. The shielding should be connected to ground at both ends of the cable.

NOTE: If the cable linking two encoders transmits data as well as the power supply, use a cable consisting of two twisted pairs that are shielded separately.

Accessories

List of accessories

The list of available accessories is as follows:

Description		Type
Reducing ring *	0.59 in to 0.55 in	XCC R358RDL14
Reducing ring *	0.59 in to 0.47 in	XCC R358RDL12
Reducing ring *	0.59 in to 0.39 in	XCC R358RDL10
Reducing ring *	0.59 in to 0.31 in	XCC R358RDL08
Reducing ring *	0.59 in to 0.24 in	XCC R358RDL06

* Only for hollow shafts

Assembly instructions

Encoder with output shaft:

Connect the encoder shaft to the revolving shaft using an XCC RA coupling.

Encoder with hollow shaft:

Position the encoder, fix it on the revolving shaft using the loop clamp, with or without the reducing ring. Then attach the flexible kit to a fixed support.

Do not tighten the fixing ring if the driving shaft and the bushing are missing from the encoder.

Installation Precautions

Precautions

Follow the instructions below:

- Do not knock over the encoder and do not expose it to excessive vibration. The encoder is a precision device.
- Do not open the encoder casing (this does not mean that the connection base cannot be removed).
- The encoder shaft must be connected to the shaft to be measured by means of an appropriate coupling. This coupling is used to dampen vibrations and compensate for any imbalance at the encoder shaft, and also to prevent any significant unauthorized force. Schneider-Electric offers appropriate couplings.
- Schneider-Electric absolute encoders are robust, but when used in difficult environmental conditions they must still be protected appropriately. The encoder must not be used as a handle or a step.
- Only qualified personnel can commission and operate these encoders. Such personnel are authorized to commission, connect to ground and identify the devices, systems and circuits in compliance with current safety standards.
- No electrical modifications should be made to the encoder.
- Route the connection cable from the bus to the encoder, ensuring it is a sufficient distance or completely separate from the power supply cables and associated electromagnetic interference. Use fully shielded cables to obtain reliable data transfer and ensure correct grounding.
- In environments subject to interference, it is advisable to ground the encoder.

DANGER

RISK OF ELECTROCUTION

- Switch off the power supply before working on this device.
- Check that the rotating machine is immobilized before working on this device.
- Close the cover correctly after configuration or wiring the microswitch.

Failure to follow these instructions will result in death or serious injury.

⚠ WARNING**UNINTENDED EQUIPMENT OPERATION**

- Check the electrical connections to avoid short-circuits and voltage peaks.
- Check the connections before use and when carrying out maintenance operations.
- Comply with the recommendations for use

Failure to follow these instructions can result in death, serious injury, or equipment damage.

CAUTION**LOSS OF PROTECTION LEVEL IP**

Close the cover correctly after configuration or wiring the microswitch.

Failure to follow these instructions can result in equipment damage.

Characteristics

3

Encoder Characteristics

Mechanical Characteristics

The mechanical characteristics are as follows:

Shaft type	∅ 10 mm h8 (0.39 in h8) ∅ 15 mm F7 (0.59 in F7)
Maximum rotation speed	6000 rpm
Moment of inertia	30 g.cm ²
Torque	0.3 N.cm
Maximum load	Radial 11 daN

Electrical Characteristics

The electrical characteristics are as follows:

Supply voltage	⎓ 11...30 V. Max. ripple: 500 mV
No-load current consumption	100 mA
Frequency	800 kHz

Environmental Characteristics

The environmental characteristics are as follows:

Conformity	CE	
Ambient air temperature	Operation	-40...+85°C (-40...+185°F)
	Storage	-40...+85°C (-40...+185°F)
Degree of protection	IP 64	
Vibration resistance	10 g (f = 10...2000 Hz), acc. to IEC 60068-2-6	
Shock resistance	100 g (6 ms, 1/2 sine wave) acc. to IEC 60068-2-27	

Immunity to electromagnetic interference	Electrostatic discharges	Acc. to IEC 61000-4-2: level 2, 4 kV air, 2 kV contact
	Radiated electromagnetic fields (electromagnetic waves)	Acc. to IEC 61000-4-3: level 3, 10 V/m
	Fast transients (On/Off interference)	Acc. to IEC 61000-4-4: level 3, 2 kV (1 kV for the I/O)
	Impulse voltage	Acc. to 61000-4-5: level 1, 500 V
Materials	Base	Aluminum
	Cover	Aluminum
	Shaft	Stainless steel
	Bearings	Steel balls 6000ZZ1 (solid shaft) - 6803ZZ (hollow shaft)

Configuration

4

Overview

The purpose of this chapter is to describe the configuration parameters for the absolute encoder with PROFIBUS-DP interface.

What's in this Chapter?

This chapter contains the following topics:

Topic	Page
Encoder Configuration	28
Software Configuration	30
SyCon Configuration Tool	31

Encoder Configuration

General

The absolute encoder with PROFIBUS-DP interface can be programmed to suit the user's requirements. The GSD file corresponding to the encoder must be installed in the software workshop of the configuration master of the PROFIBUS network used.

The file contains various configurations.

NOTE: THE 2.2 MULTI-TURN VERSION IS THE ONLY ONE AVAILABLE.

The encoder supports specific functions and the encoder configuration that are stored in the PROFIBUS master. When the PROFIBUS network starts up ("DDL_M_Set_Prm"), they are sent to the slave (encoder). The parameters and the configuration cannot be modified when the encoder is operating in normal mode (exception: "Commissioning mode", see *Commissioning Mode, page 48*).

After receiving the parameter-setting and configuration data, the absolute encoder switches to normal operating mode (cyclic data transmission – "DDL_M_Data_Exchange"). In this mode, the process values (example: position value) are transmitted. The data length and format are determined by the user when selecting an encoder configuration.

Configuration

Download the GSD file and its 3 associated images from "www.telemecanique.com":

- TELE4711.gsd
- TELE4711_R.bmp
- TELE4711_S.bmp
- TELE4711_D.bmp

The system is configured as shown in the diagram below:

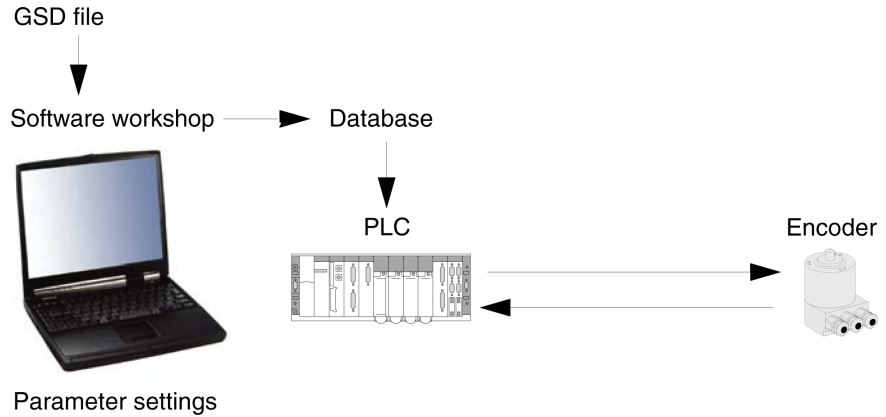

Functions

The table below contains the encoder functions:

Cyclic communication	Programmable parameters	Additional functions
<ul style="list-style-type: none"> • Position value (32 input bits) • Default value/Teach-in procedure (32 output bits) • Speed (16 input bits) 	<ul style="list-style-type: none"> • Code sequence • Scale factor • Shorter diagnostics • Limit switches • Speed time base 	<ul style="list-style-type: none"> • Preset function • Commissioning mode • Speed output

Data Format

Data exchanged between the master and the encoder:

Configuration		Input words (Encoder -> Master)	Output words (Master -> Encoder)	Description
Hex.	Dec.			
F1	241	2	2	<i>Functions, page 37</i>
D0	208	1	2	

Software Configuration

Principle

The encoders described in this section are configured using the following software:

Setting the network parameters	SyCon version \geq 2.9
PLC programming	Unity Pro version \geq 4.0

Please refer to the software documentation for the minimum PC configuration used.

SyCon Configuration Tool

Presentation

Using this software tool, it is possible to configure the PROFIBUS network and generate an ASCII file for the Premium PLC.

Configuring the PROFIBUS Network and Generating an ASCII File

Steps to follow when configuring the PROFIBUS Network and generating an ASCII file:

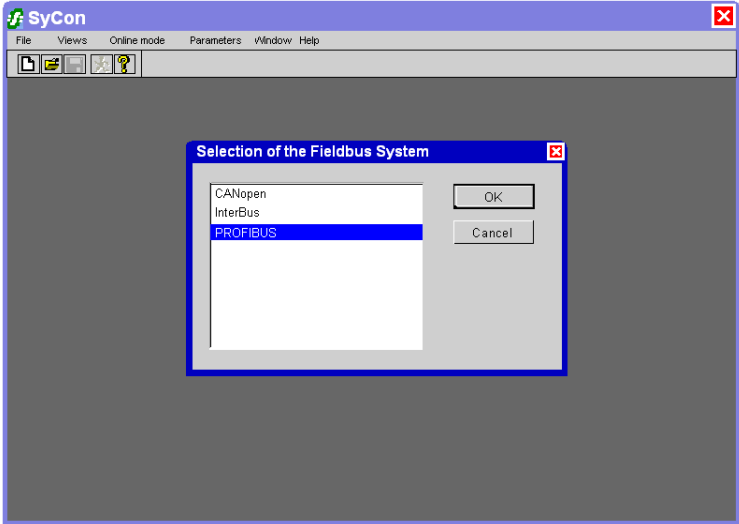
Step	Action
1	<p>To configure the slave, obtain the TELE4711.GSD file and place it in the appropriate directory: Example: "C:\Program Files\Schneider Electric\SyCon\Fieldbus\PROFIBUS\GSD". Also obtain the 3 associated images and place them in the appropriate directory: Example: "C:\Program Files\Schneider Electric\SyCon\Fieldbus\PROFIBUS\BMP". In this example, a Schneider Premium controller acts as PROFIBUS MASTER with the TSX PBY 100 PROFIBUS interface.</p>
2	Start SyCon.
3	<p>Select the PROFIBUS fieldbus system.</p> 

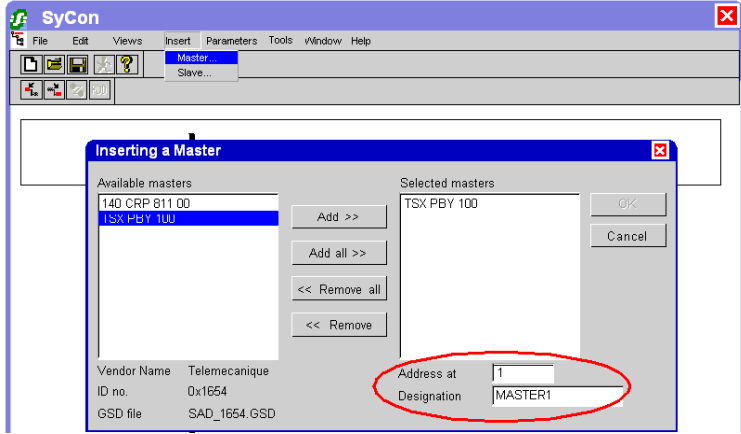
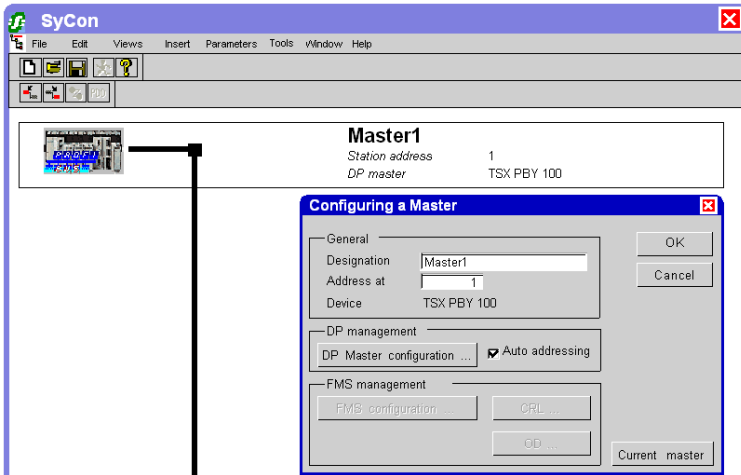
Step	Action
4	<p>Insert the Master:</p> <p>In the menu, select "Insert/Master" (you should specify where the master should be inserted).</p> <p>Select "TSX PBV 100" from the available masters.</p> <p>Click "Add".</p> <p>Enter the network address and the designation of the master:</p>  <p>Click "OK" to confirm and close the window.</p> <p>Result: After inserting the Master, double-click on the icon representing the master in the main window to obtain the following configuration window:</p> 
5	<p>Using the rotary switches, adjust the encoder in order to configure the address (see <i>Encoder Address</i>, page 17).</p>

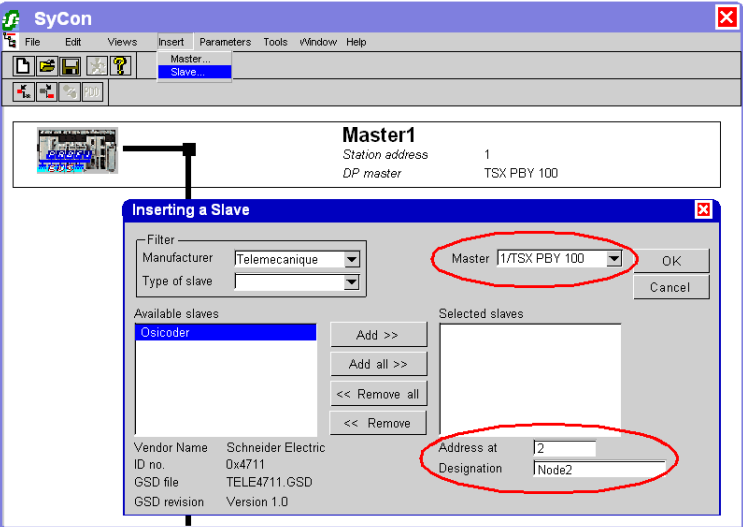
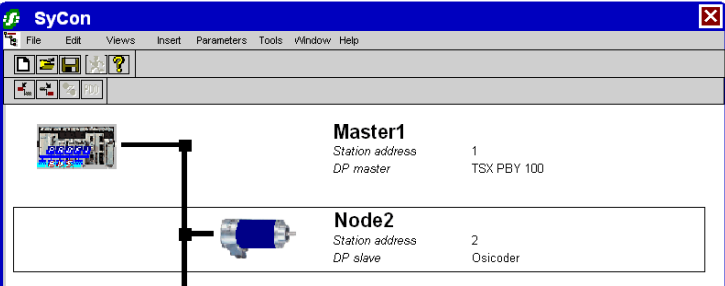
Step	Action
6	<p>Insert the slave (encoder):</p> <p>In the menu, select "Insert/Slave" (you should specify where the slave should be inserted).</p> <p>Select the encoder and click "Add".</p> <p>Enter the network address (in accordance with the position of the rotary switches) and also the designation of the encoder.</p> <p>If the network includes several masters, select the required master for the encoder. In this example, it is the TSX PBY 100 interface:</p>  <p>Click "OK" to confirm and close the window.</p> <p>Result: After inserting the Slave, the window looks like this:</p> 

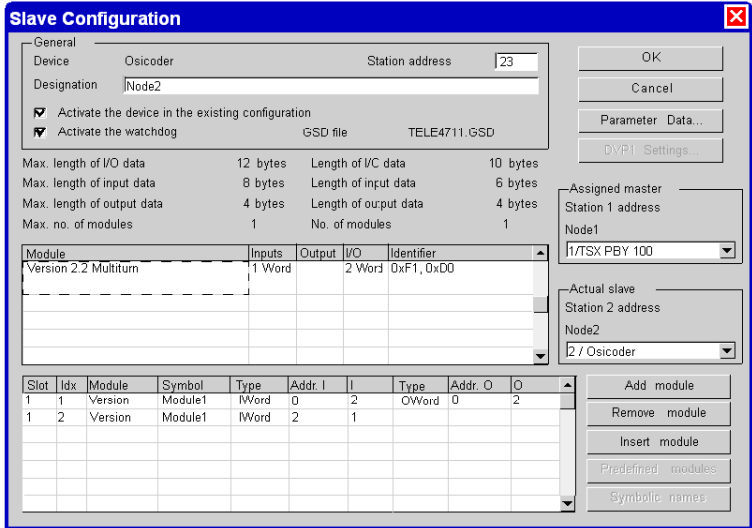
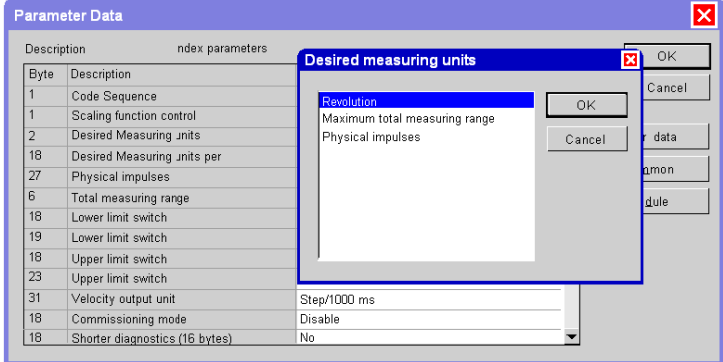
Step	Action
7	<p>By clicking twice on NODE2, you can configure the encoder. Slave configuration window:</p>  <p>Note: THE 2.2 MULTI-TURN VERSION IS THE ONLY ONE AVAILABLE. Click "OK" to confirm and close the window.</p>
8	<p>Click on "Parameter Data..." to configure the encoder. Double-click on a value to modify it:</p>  <p>Click "OK" to confirm the value, then click "OK" again to close the window. For further information on the encoder parameters, see <i>Functions, page 37</i>.</p>

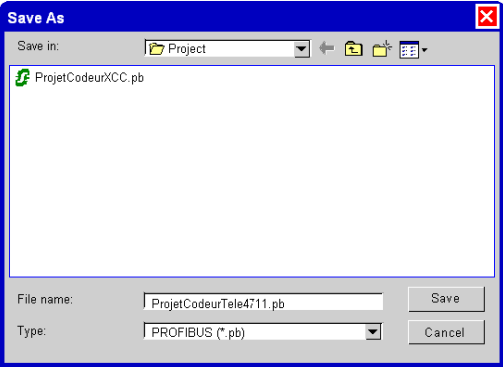
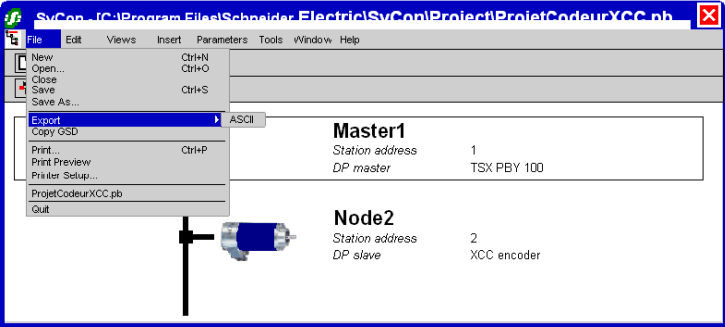
Step	Action
9	<p>In the menu, select "File/Save As..." :</p> 
10	<p>Select the master and then, in the menu, select File/Export/ASCII":</p>  <p>The created file is a "CNF" file type. Note: The file name must have 15 characters maximum.</p>

Result

The fieldbus master file is now ready.

The "CNF" file created with the SyCon software should be integrated by the PLC software in order to be available.

Functions

5

Overview

The purpose of this section is to describe the various parameters that can be configured in order to customize use of the encoders.

What's in this Chapter?

This chapter contains the following topics:

Topic	Page
Description of the Encoder Profile	38
Description of Functions	40
Data Exchange	47
Commissioning Mode	48

Description of the Encoder Profile

List of Functions

 **CAUTION**

UNINTENDED EQUIPMENT OPERATION

For double-word writing, write words WORD 0 and WORD 1 in the correct order according to the PLC used.

Failure to follow these instructions can result in injury or equipment damage.

The list of encoder parameters is as follows:

PROFIBUS byte no.	SyCon parameter no.	Parameter	Bit no.
1...8	-	PROFIBUS standard parameters (non-configurable)	
9	1	Code Sequence	0
		Classe 2 functionality	1
		Commissioning diagnostics (not implemented)	2
		Scaling function control	3
		Reserved	4
		Reserved	5
		Activation of manufacturer-specific parameters (byte 26)	6
		Reserved	7
10...13	2...5	Desired measuring units (see: bits 0 and 1 of byte 26)	
14...17	6...9	Total measuring range	
18...25	10...17	Reserved	
26	18	Basis for desired measuring units	0
			1
		Commissioning mode	2
		Shorter diagnostics	3
		Reserved	4
		Activate lower limit switch	5
		Activate upper limit switch	6
		Activation of bytes 27-39	7
27...30	19...22	Lower limit switch	
31...34	23...26	Upper limit switch	

PROFIBUS byte no.	SyCon parameter no.	Parameter	Bit no.
35...38	27...30	Physical impulses	
39	31	Reserved	0
		Encoder type (Singleturn/Multiturn)	1
		Reserved	2
		Reserved	3
		Velocity output unit	4
			5
		Reserved	6
		Reserved	7

Description of Functions

Note

Check the difference in the function numbers given by the PROFIBUS-DP standard and the SyCon software. The configurable function numbers in SyCon run from 1 to 31 whereas they run from 9 to 39 in the PROFIBUS-DP standard (function number 1 in SyCon = function number 9 for PROFIBUS-DP).

Code Sequence

The "Code sequence" parameter defines the counting direction for the position value. The code is incremented when the shaft turns in a clockwise (CW) or counter-clockwise (CCW) direction (as seen from the shaft). The code sequence is defined in bit 0 of byte 9:

Byte 9 Bit 0	Direction of rotation as seen on the shaft	Code
0	Clockwise (CW)	Ascending
1	Counter-clockwise (CCW)	Ascending

Classe 2 fonctionnalité

Allows Class 2 encoders to be used as Class 1 encoders. The scaling parameters are deactivated. To use Class 2 functionality, bit 1 of byte 9 must be activated.

Byte 9 Bit 1	Class 2 functionality
0	Inactive
1	Active

Commissioning diagnostics

This function is not implemented.

Scaling function control

The "Scaling function control" parameter activates the "Step per revolution" and "Total resolution" scaling parameters. It must always be activated to use Class 2 functions.

Byte 9 Bit 3	Scaling
0	Inactive
1	Active

Activation of Manufacturer-Specific Parameters

Byte 26 of the manufacturer-specific parameters is activated with bit 6 of byte 9.

The user only needs to monitor this point if the parameters are entered "manually" (using hexadecimal code directly).

Byte 9 Bit 6	Byte 26
0	Inactive
1	Active

Desired measuring units

The "Desired measuring units" parameter is used to program the desired number of steps for 1 revolution, for all or part of the measuring range.

If the specified value is more than the encoder base resolution (physical), the output code no longer operates in single steps. By generating a "B1" message, the encoder indicates a parameter error (LED) and does not switch to data exchange mode.

Byte	10	11	12	13
Bit	31-24	23-16	15-8	7-0
Data	$2^{31} \dots 2^{24}$	$2^{23} \dots 2^{16}$	$2^{15} \dots 2^8$	$2^7 \dots 2^0$
Function	Desired measuring units			

The basis for the desired measuring units is specified with the "Basis for desired measuring units" parameter (see *Basis for desired measuring units, page 42*). If "Per revolution" is selected, the measuring range can be adapted with the "Total measuring range" parameter. Follow the rules specified for the *Total measuring range, page 41*.

Note: Many software tools require the value to be divided into least significant and most significant words.

Total measuring range

The total measuring range is as follows:

Byte	14	15	16	17
Bit	31-24	23-16	15-8	7-0
Data	$2^{31} \dots 2^{24}$	$2^{23} \dots 2^{16}$	$2^{15} \dots 2^8$	$2^7 \dots 2^0$
Function	Total measuring range			

The "Total measuring range" parameter is used to adapt the encoder measuring range to the actual measuring range of the application. The encoder counts until the position value has reached the programmed total resolution and starts again from 0 (loopback).

Many software tools require the value to be divided into least significant and most significant words. In total resolution, the following rule must be adhered to:

Desired measuring units per revolution: The position value is incremented by the number of programmed steps (desired measuring units) during a revolution. The "Total resolution" parameter is used to adapt the measuring range (see *Total measuring range*, page 41).

Desired measuring units per maximum total measuring range: The "Desired measuring units" parameter refers to the complete measuring range of the encoder: the encoder indicates the programmed number of measuring units for the whole measuring range (4096 revolutions with the multi-turn encoder).

Desired measuring units per physical impulse: The measuring units refer to the physical impulses specified in bytes 35-39 (see *Physical impulses*, page 45). The physical impulses correspond to the actual value read internally from the encoder disk (for example: 8192 points per revolution).

With this option, it is possible to set the reduction factors without restriction:

Basis	Byte 26 bit 0	Byte 26 bit 1
Per revolution	0	0
Per maximum total measuring range	1	0
Per physical impulse (= steps specified in bytes 35-38)	0	1

Activate commissioning mode

Bit 2 of byte 26 is used to activate commissioning mode. This is a special mode that can be used to set other parameters in data exchange mode (apart from the preset value). In commissioning mode, it is possible to use a "Teach-In" procedure (the reduction factor can be determined directly by the encoder). When this special mode, indicated by a flashing green LED, is activated, the parameters defined in the system configuration are ignored by the encoder. Commissioning mode uses parameters stored in an internal EEPROM memory.

This mode can be used over a long period but it is advisable to transfer the parameters determined with the "Teach-In" procedure to the system configuration. The encoder should then be used in "normal" operating mode, which means the exchange can be performed without using a new "Teach-In" procedure.

See *Commissioning*, page 48 for more details.

Byte 26 Bit 2	Commissioning mode
0	Inactive
1	Active

Shorter diagnostics

Some PROFIBUS masters encounter problems with the length of the full diagnostic data (57 bytes). The Telemecanique encoder offers an option which allows the length of this data to be reduced to 16 bytes. In Class 1, the standard diagnostic data length is 16 bytes.

Byte 26 Bit 3	Diagnostics
0	Standard = 57 bytes
1	Shorter = 16 bytes

Software Limit Switch

Two positions (upper and lower limit switch) can be programmed and define a range. If the position value is within this range, bit 27 of the 32-bit process value is set to 1. Outside this range, bit 27 is set to 0. The limit switches can be set to any value once this value is less than that specified for the "Total measuring range" parameter. The limit switches are activated with bits 5 and 6 of byte 26.

Note: Many software tools require the value to be divided into least significant and most significant words.

Byte	27	28	29	30
Bit	31-24	23-16	15-8	7-0
Data	$2^{31} \dots 2^{24}$	$2^{23} \dots 2^{16}$	$2^{15} \dots 2^8$	$2^7 \dots 2^0$
Function	Lower limit switch (in measuring steps, compared to the scaling value)			

Byte	31	32	33	34
Bit	31-24	23-16	15-8	7-0
Data	$2^{31} \dots 2^{24}$	$2^{23} \dots 2^{16}$	$2^{15} \dots 2^8$	$2^7 \dots 2^0$
Function	Upper limit switch (in measuring steps, compared to the scaling value)			

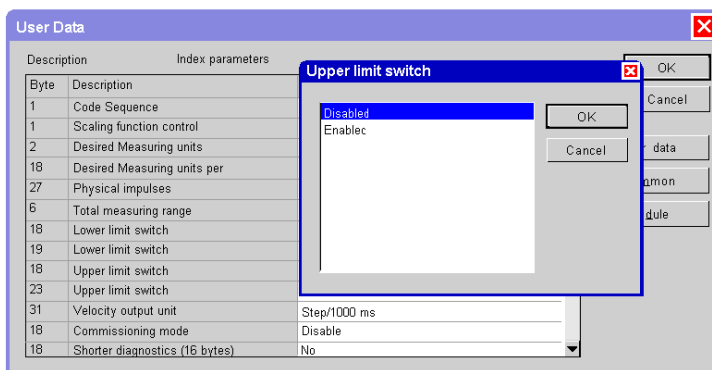

Byte 26 Bit 5	Lower limit switch
0	Inactive
1	Active

Byte 26 Bit 6	Upper limit switch
0	Inactive
1	Active

Activation of Bytes 27 to 39

Bit 7 of byte 26 is used to activate other parameter bytes (27-39)

Byte 26 Bit 7	Byte 27 - 39
0	Inactive
1	Active

Physical impulses

Byte	35	36	37	38
Bit	31-24	23-16	15-8	7-0
Data	$2^{31} \dots 2^{24}$	$2^{23} \dots 2^{16}$	$2^{15} \dots 2^8$	$2^7 \dots 2^0$
Function	Physical impulses			

This parameter is assessed if the basis for the "Desired measuring units" is expressed in "Physical impulses" (see *Basis for desired measuring units, page 42*).

The "Physical impulses" parameter is used to set a reduction factor without restriction. The user defines the output steps ("Desired measuring steps") on part of the measuring range. This option is useful for programming scale factors generating a non-whole number of steps for 1 revolution.

Example:

Requirement: The position value has been incremented by 400 steps during 3 revolutions.

With the "Steps per revolution" basis, it is not possible to program this scale factor (the "Desired measuring steps" parameter should be set) to 133.33, as this parameter must be assigned to a whole value).

Solution: Choose "Physical impulses" as the basis for "Desired measuring units".

The number of physical measuring steps for the desired measuring range is determined. To obtain this value, the actual resolution (physical) of the encoder (label) is used. In the example given, this would be (with a standard encoder, 12-bit resolution):

4096 steps/revolution x 3 revolutions = 12288 steps

Enter the value (12288) as "Physical impulses" and set "Desired measuring units" to 400. The encoder increments the position value by 400 steps over a measuring range of 12288 physical steps (3 revolutions).

Encoder type

The encoder type (Single-turn or Multi-turn) is specified in bit 1 of byte 39:

Byte 39 Bit 1	Type
0	Single-turn
1	Multi-turn

Velocity output unit

This parameter allows the user to choose the time base applicable to the output speed. The time base can be configured by bits 4 and 5 of byte 39.

Time base	Bit 4	Bit 5
Step/Second	0	0
Step/100 ms	1	0
Step/10 ms	0	1
Rpm (revolutions per minute)	1	1

Data Exchange

Data Exchange Format in Normal Operating Mode

"DDL_M_Data_Exchange mode" indicates the encoder normal operating mode. The encoder is a slave. It communicates the current position at the master's request. The encoder can also receive data issued by the master (for example: the preset value in the Class 2 configuration).

The encoder transmits values coded on 32 bits, 25 bits for the position value and the other 7 for the status bits.

The absolute encoder can have a position (physical) ≤ 33554432 points (25 bits). Beyond this, these values are not supported by the encoder. The higher bits will be overwritten by the status bits. If the encoders have a total resolution (physical) > 25 bits, the user must make sure that the position value is scaled with a maximum output value < 33554432 .

The current speed is transmitted in an additional input (peripheral) word.

ID	F1 Hex					D0 Hex	
Encoder -> Master	Status	Position value				Speed	
	$2^{31} - 2^{25}$	2^{24}	$2^{23} - 2^{16}$	$2^{15} - 2^8$	$2^7 - 2^0$	$2^{15} - 2^8$	$2^7 - 2^0$
Master-> Encoder	Status	Preset value					
	$2^{31} - 2^{25}$	2^{24}	$2^{23} - 2^{16}$	$2^{15} - 2^8$	$2^7 - 2^0$		

Meaning of the various status bits:

Bit 28	Bit 27	Bit 26	Bit 25	Meaning
				<p>Ready 0 = the encoder is not ready to operate. 1 = the encoder is ready to operate.</p>
				<p>Mode 0 = commissioning mode. 1 = normal mode.</p>
				<p>Software limit switch 0 = lower limit switch \leq current position value \leq upper limit switch. 1 = current position value $>$ upper limit switch or current position value $<$ lower limit switch.</p>
				<p>Code sequence 0 = incrementation in clockwise direction (seen from the shaft side). 1 = incrementation in anti-clockwise direction.</p>

Commissioning Mode

Commissioning

If commissioning mode is activated in the encoder parameters, the scale factor can be determined directly in the machine with a "Teach-In" procedure. Commissioning mode is indicated by the green LED flashing and bit 26 in the input word (bit 26 set to 0).

If the encoder starts in commissioning mode, the parameters specified in the system configuration (code sequence, scaling) are ignored. The parameters used are stored in an internal EEPROM memory. If the code sequence or the scale factor are modified in commissioning mode, the new values are stored in a non-volatile memory and the encoder uses these new parameters.

To switch to commissioning mode, proceed as follows:

Step	Action
1	Install the encoder in the machine/system.
2	Activate commissioning mode (parameter settings, see <i>Commissioning, page 48</i>
3	Change the counting direction (if necessary).
4	Place the machine/system in the startup position.
5	Send the encoder the "Teach-In-Start" command.
6	Place the machine/system in the stop position.
7	Indicate the desired number of steps to the encoder with the "Teach-In-Stop" command.
8	Define the preset value.
9	Assign the values determined with the "Teach-In" procedure to the system configuration parameters.
10	Deactivate commissioning mode (parameter setting).

Setting the Counting Direction

If the encoder is operating in commissioning mode, the counting direction (Code Sequence) can be modified online. The current code sequence is indicated with bit 28 in the 32-bit process value (0: incrementation in clockwise direction /1: incrementation in anti-clockwise direction). The counting direction can be changed with bit 28 of the double output word (falling edge).

	Status bits							Data bits			Description
	31	30	29	28	27	26	25	24	...	0	
Master -> Encoder	0	0	0	1	0	0	0				Changing the counting direction by setting bit 28
Encoder -> Master	0	0	0	0/1	0	0	1			0/1	The encoder sends an acknowledgement (new counting direction in bits 0 and 28)
Master -> Encoder	0	0	0	0	0	0	0				The change is finalized by resetting bit 28
Encoder -> Master	0	0	0	0/1	X	0	1				Process output value with a modified counting direction

Starting the "Teach-In" Procedure

When the machine connected to the encoder is in the startup position, the "Teach-In-Start" command is sent to the encoder. The encoder starts the internal calculation of a new scale factor.

	Status bits							Data bits			Description
	31	30	29	28	27	26	25	24	...	0	
Master -> Encoder	0	1	0	0	0	0	0				Setting bit 30 to 1 to start the "Teach-In" procedure
Encoder -> Master	0	1	0	X	X	0	1				Setting bit 30 to 1 for transmission of an acknowledgement by the encoder)
Master -> Encoder	0	0	0	0	0	0	0				Resetting bit 30
Encoder -> Master	0	1	0	X	X	0	1				The uncalculated position value is sent (reduction factor = 1, no offset)

Note: The scale factor is set to 1; the zero point offset is set to zero.

Stopping the "Teach-In" Procedure

When the machine connected to the encoder is in the stop position, the " Teach-In-Stop" command is sent. The desired number of steps per modified measuring range is sent with this command. The user should check that the physical resolution has not been exceeded (for example: 20000 steps for a quarter turn). Both negative and positive directions are automatically taken into account, as is crossing the physical zero point.

Note: The measuring range must not exceed half the encoder physical measuring range (2047 revolutions maximum for a multi-turn encoder performing 4096 revolutions and 8191 revolutions maximum for a 12-bit multi-turn encoder).

After receipt of the "Teach-In-Stop" command, the encoder transmits the calculated total resolution. Note down the value, then when the encoder switches back to normal mode, enter the value in the parameter settings.

After this procedure, the encoder operates with the new reduction factor (which is stored in a non-volatile internal EEPROM memory).

	Status bits							Data bits			Description
	31	30	29	28	27	26	25	24	...	0	
Master -> Encoder	0	0	1	0	0	0	0				Desired number of steps (for the relevant measuring range)
Encoder -> Master	0	1	1	X	X	0	1				Transferring the total resolution (to be noted down)
Master -> Encoder	0	0	0	0	0	0	0				Resetting bit 29
Encoder -> Master	0	0	0	X	X	0	1				Current position value output, scaling with the new reduction factor

To replace the encoder at a later date without using a new "Teach-In" procedure, the total measuring range determined with the "Teach-In" procedure must be transferred to the system configuration. For this, "Total resolution" must be specified in the "Desired measuring units" parameter field (see *Desired measuring units, page 41*) and the basis (see *Basis for desired measuring units, page 42*) must be set to "Maximum total measuring range". When setting the parameters, check the Code sequence (the counting direction set in commissioning mode must be transferred to the system configuration). Commissioning mode can then be deactivated and the encoder can be used in normal mode.

"Preset" Values

Using the preset function, it is possible to adapt the encoder zero point according to the application zero point. With this function, the current encoder position value is set to the desired preset value. The integrated microcontroller calculates the internal zero point offset. This value is stored in a non-volatile EEPROM memory (this operation takes less than 40 ms).

The preset value is activated if bit 31 of the double output (peripheral) word is set to 1 (rising edge). As the preset function is used after receipt of the scaling parameters, the preset value corresponds to the scaling position value.

When bit 31 of the input double word is set to 1, an acknowledgement is sent.

	Status bits							Data bits			Description
	31	30	29	28	27	26	25	24	...	0	
Master -> Encoder	1	0	0	0	0	0	0				Transferring the desired position value (= "Preset" value)
Encoder -> Master	1	0	0	0	0	0	1				The desired position value is transferred
Master -> Encoder	0	0	0	0	0	0	0				Resetting bit 31 – normal mode
Encoder -> Master	0	0	0	0	0	0	1				The desired position value is transferred

NOTE: This parameter can be used for a RESET or SET function.

Diagnostics



Overview

This chapter describes the various diagnostic messages that can be generated by the encoder.

What's in this Chapter?

This chapter contains the following topics:

Topic	Page
Diagnostic Messages	54
Status Indication Provided by the LEDs in the Base	57
FAQ	59

Diagnostic Messages

Principle

At the master's request, the encoder sends diagnostic data ("DDL_M_Slave_Diag"). The length of this data is 57 bytes (Exception: diagnostics, *Shorter diagnostics, page 44*). The format of the diagnostic data depends on the PROFIBUS standard (bytes 1-6) and the Encoder profiles (beginning with byte 7).

Diagnostic Function

The table below gives the list of encoder diagnostic functions:

Diagnostic function	Data type	Diagnostics - byte number
Station 1 status (see: PROFIBUS standard)	Byte	1
Station 2 status (see: PROFIBUS standard)	Byte	2
Station 3 status (see: PROFIBUS standard)	Byte	3
Diagnostic master address	Byte	4
PNO identification number	Byte	5, 6
Extended diagnostic header	Byte string	7
Alarm messages	Byte string	8
Operating status	Byte string	9
Encoder type	Byte string	10
Resolution per revolution (hardware)	Unsigned 32	11-14
Number of revolutions (hardware)	Unsigned 16	15-16
Reserved	-	17-23
Profile version	Byte string	24-25
Software version	Byte string	26-27
Operating time	Unsigned 32	28-31
Zero offset	Unsigned 32	32-35
Manufacturer-specific: offset value	Unsigned 32	36-39
Programmed resolution per revolution	Unsigned 32	40-43
Total programmed resolution	Unsigned 32	44-47
Serial number	ASCII string	48-57

Extended Diagnostic Header

Diagnostic byte 7 specifies the length of the extended diagnostics (including the header).

Memory Error

Bit 4 of diagnostic byte 8 indicates a memory error.

We talk about a memory error when the encoder internal EEPROM memory no longer works correctly and it is not possible to guarantee that the values (the offset values for example) have been stored in non-volatile memory.

Bit	Definition	0	1
4	Memory error (EEPROM default)	No	Yes

Operating Status

Diagnostic byte 9 contains the parameters set in the system configuration.

Bit	Definition	0	1
0	Direction of rotation	CW	CCW
1	Class 2 functionality	Inactive	Active
2	Diagnostic routine	Inactive	Active
3	Scaling function	Inactive	Active

Encoder Type

Diagnostic byte 10 specifies the encoder version (Single-turn or Multi-turn).

Byte 10	Definition
0	Single-turn encoder
1	Multi-turn encoder

Single-turn Resolution

Diagnostic bytes 11-14 specify the actual resolution (physical) per encoder revolution.

Number of Revolutions

Diagnostic bytes 15 and 16 specify the actual number (physical) of revolutions completed by the encoder. The multi-turn version goes from 1 to 4096 revolutions maximum.

Operating Time Alarm

Bit 4 of diagnostic byte 21 contains an alarm concerning the operating time. This bit is set after 10^5 hours.

Profile Version

Diagnostic bytes 24 and 25 indicate the encoder profile version.

Byte	24	25
Bit	15-8	7-0
Data	$2^7 - 2^0$	$2^7 - 2^0$
	Revision no.	Index

Software Version

Diagnostic bytes 26 and 27 indicate the encoder software version.

Byte	26	27
Bit	15-8	7-0
Data	$2^7 - 2^0$	$2^7 - 2^0$
	Revision no.	Index

Operating Time

The encoder operating time is indicated in diagnostic bytes 28 to 31. If the encoder is supplied with power, the operating time is saved to the EEPROM memory every six minutes in steps of 0.1 hour.

Zero Offset

The zero offset is indicated in diagnostic bytes 32 to 35.

Programmed Resolution

The programmed resolution per revolution is indicated in diagnostic bytes 40 to 43. The value is only valid if the scale factor is based on the "Step per revolution" parameter (see *Basis for desired measuring units, page 42*).

Total Programmed Resolution

The total calculated and programmed resolution is indicated in diagnostic bytes 44 to 47 (MAX RANGE).

Serial Number

Diagnostic bytes 48-57 are reserved for the serial number.

Note: With the current version, the serial number is not saved in the encoder, so the bytes contain the default hexadecimal value 2A.

Status Indication Provided by the LEDs in the Base

Principle

Two LEDs are located on the base. They indicate the status of the encoder in the PROFIBUS network.

The red LED indicates errors. The green LED indicates the encoder status.

These two LEDs can be either off, on or flashing. Seven of the nine possible combinations indicate a special condition.

In the event of problems on system startup, the LED status can provide invaluable information on the cause of the error.

Description

LED on the base:

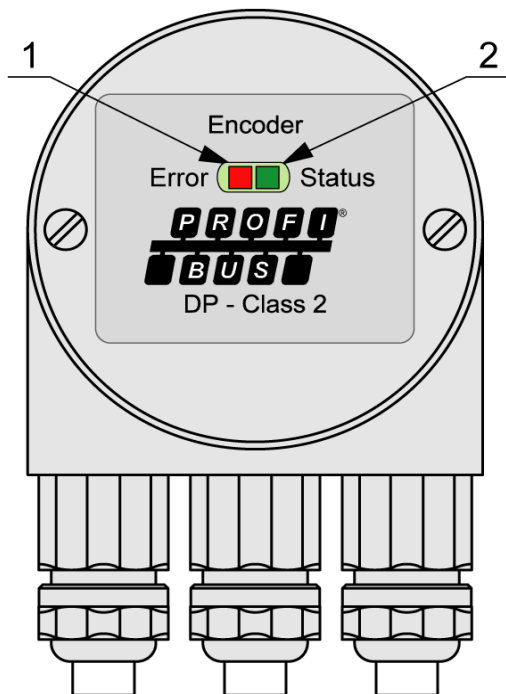

No.	Description
1	RED LED
2	GREEN LED

LED status table for diagnostics:

No.	Red LED	Green LED	Status/possible cause
1	Off	Off	No electrical supply
2	On	On	The encoder is ready to operate but has not received any configuration data since being powered up. Possible causes: incorrect addressing, bus lines incorrectly connected
3	On	Flashing	Configuration or parameter error. The encoder is receiving parameter or configuration data that is inconsistent or the incorrect length. Possible cause: the value of the "total measuring range" parameter is too high.
4	Flashing	On	The encoder is ready to operate but is not being addressed by the master (for example: incorrect address in the configuration).
5	On	Off	The encoder has not received any data for a long time (approx. 40 s). Possible cause: the bus line has been interrupted.
6	Off	On	Normal operation in data exchange mode
7	Off	Flashing	Commissioning mode

FAQ

Problem	Possible cause	Possible solutions
Problems with the PROFIBUS network (bus error, absence of encoder response)	The master does not support the full diagnostic data length (57 bytes).	In the master, increment the maximum number of diagnostic data authorized for each slave. If this operation is not possible, the encoder can be used with shorter diagnostics (see <i>Shorter diagnostics, page 44</i>).
With COM PROFIBUS Version 5.0, it is not possible to insert the Telemecanique encoder in the hardware configuration.	The master does not support the full diagnostic data length (57 bytes). COM PROFIBUS V5.0 checks the GSD parameter "Max_Diag_Data_Len=57" and prevents simultaneous configuration of both devices.	Use COM PROFIBUS Version 3.3 and activate the shorter diagnostics function. With COM PROFIBUS V5.0, the Telemecanique encoder can only be configured with a modified GSD file (the slave key "Max_Diag_Data_Len" must be changed).
The PLC and the master are powered up, the bus is active but the encoder does not respond.		Check the status of the LEDs in the base (see <i>Status Indication Provided by the LEDs in the Base, page 57</i>). Both LEDs are off: check the power supply! Both LEDs are on: The encoder is ready but is not receiving any parameter-setting or configuration telegrams. Check the address in the base. Check the connection of the bus lines (BUS IN/BUS OUT). Check the hardware configuration in the software tool. Red LED on, green LED flashing: parameter error! Check the parameters, for example the parameter-setting rules applicable to the total measuring range (see <i>Total measuring range, page 41</i>)
Random bus errors	The line termination resistors are incorrect.	Check the termination resistors! The 220 Ω resistors must be activated at the start and end of the bus segment. Turn off the power and measure the resistance between terminals A and B in the base. This resistance should be approx. 110 Ω (220 Ω in parallel).
	EMC problems	Is the transmission speed used compatible with the length of the bus lines? Try and use a slower speed if necessary. Check the shielding is properly connected in the base. Do the cables and conductors comply with all the EMC rules?

Glossary

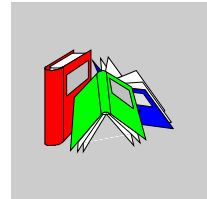

A

Address

Number, assigned to each node, irrespective of whether it is a master or slave. The address (non-volatile) is configured in the base with rotary switches.

ARE

Abbreviation: absolute rotary encoder

B

Baud rate

Data transmission speed specified in the form of a number of bits transferred per second (baud rate = data rate).

Bus node

Device that can send and/or receive or amplify data by means of the bus.

Byte

8-bit unit of data = 1 byte

C

Configuration

When the master configures the slave, the properties of the latter are specified (for example: number of input and output bytes).

D

DDL

Direct Data Link Mapper: interface between the PROFIBUS-DP functions and the encoder software.

DDL Data Exchange

Bus operating status, for standard data transfers.

DDL Set Prm

Bus operating status, the configuration and parameters are transmitted.

DDL Slave Diag

Operating status, the diagnostic data are requested from the slave (for example: encoder).

Diagnostics

Identification, location, classification, display, additional evaluation of errors and messages.

DP

Distributed Peripherals

F

FAQ

Frequently Asked Questions

Freeze

Command from the master sent to the slave that can be used to freeze the state of the inputs. The input data is only updated after receipt of the UNFREEZE command.

G**GSD file**

Standardized file containing the description of the parameters and the communication methods of the associated device.

L**Line termination resistor**

Resistor terminating the main segments of the bus.

M**Master**

"Active" device within the network, that can send data without having received a request. Monitors data exchanges.

P**PNO**

PROFIBUS Nutzerorganisation

PROFIBUS

Process fieldbus, European standard for fieldbuses defined in the PROFIBUS standard (EN 50170). Specifies the mechanical, electrical and functional characteristics of a fieldbus system.

S

Slave

Bus node that sends data at the request of the master. Absolute rotary encoders are always slaves.

SyCon

Software tool with a uniform interface under Windows. Description files (GSD, EDS, etc.) are used as basic information by the software.

W

Word

Expression used for a unit of data consisting of two bytes.

Index



Symbols

"Preset" Values, 50

A

Accessoires, 21
Activate commissioning mode, 43
Activation of Bytes 27 to 39, 45
Activation of Manufacturer-Specific Parameters, 40
Assembly instructions, 21

B

Basis for desired measuring units, 42

C

Class 2 functionality, 40
Code Sequence, 40
Commissioning, 48
Commissioning diagnostics, 40
Commissioning Mode, 48
Connecting the Connection Base, 20
Connection Base, 16

D

Data Exchange, 47
Description, 16
Description of Functions, 40

Description of the Encoder Profile, 38
Desired measuring units, 41
Diagnostic Function, 54
Diagnostic Messages, 54

E

Electrical Characteristics, 25
Encoder Address, 17
Encoder type, 46
Encoder Type, 55
Environmental Characteristics, 25
Extended Diagnostic Header, 54

F

FAQ, 59

L

Line Terminator, 17
List of accessories, 21

M

Mechanical Characteristics, 25
Memory Error, 55

N

Number of Revolutions, 55

O

Operating Status, *55*
Operating Time, *56*
Operating Time Alarm, *55*

P

Physical impulses, *45*
Profile Version, *56*
Programmed Resolution, *56*

S

Scaling function control, *40*
Serial Number, *56*
Setting the Counting Direction, *49*
Shorter diagnostics, *44*
Single-turn Resolution, *55*
Software Limit Switch, *44*
Software Version, *56*
Starting the "Teach-In" Procedure, *49*
Status Indication Provided by the LEDs in
the Base, *57*
Stopping the "Teach-In" Procedure, *50*

T

Total measuring range, *41*
Total Programmed Resolution, *56*

V

Velocity output unit, *46*

W

Wiring the Bus and the Power Supply, *18*
Wiring the Encoder, *20*

Z

Zero Offset, *56*