

Concealed three-way diverter - Light Gold











CL.1

36 210 740



- rotary diverter
- without rosette
- handle Ø 60mm
- WRAS 2307045

Fits: CL.1, META, CYO

	Light Gold	36 210 740-26
	Chrome	36 210 740-00
	Brushed Platinum	36 210 740-06
	Brushed Light Gold	36 210 740-27
	Brushed Durabronze (23kt Gold)	36 210 740-28
	Matte Black	36 210 740-33
	Brushed Bronze	36 210 740-42
	Brushed Champagne (22kt Gold)	36 210 740-46
	Champagne (22kt Gold)	36 210 740-47
	Brushed Dark Platinum	36 210 740-99

Required miscellaneous



- Concealed three-way diverter -** 35 203 970 90
- min. recess depth 95 mm
 - max. recess depth 116 mm

36 210 740

mm [inches]

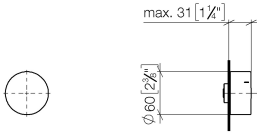

Flow rate chart

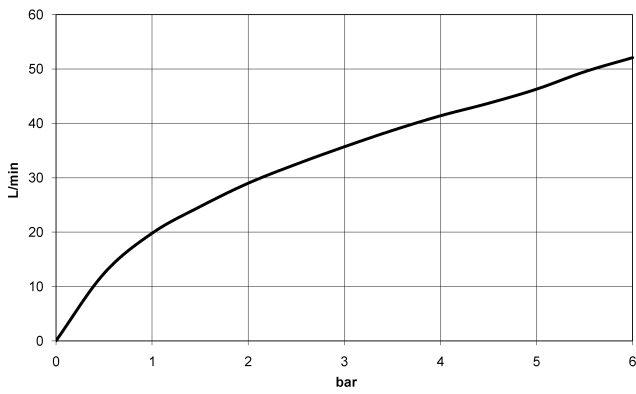

Codes & Standards

DIN 4109

ISO 3822

Scottish Water
Byelaws

UK Water Supply
Regulations

Ü-Zeichen



Concealed three-way diverter - Light Gold

CL.1

36 210 740

Certificates

WRAS_2307

LGA_38

36 210 740

Product version from 4/1/2022

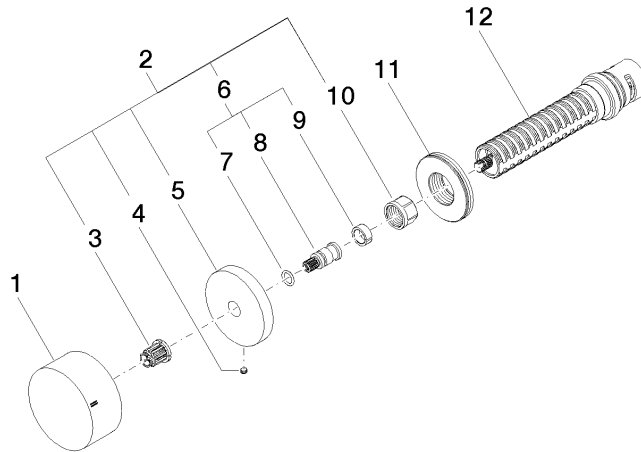



Concealed three-way diverter - Light Gold

CL.1

36 210 740

Spare parts list

Product version from 4/1/2022

No.	Item Number	Name	Quantity used	Delivery time
	09 20 74 045-26	handle	12	60