

TARA Single-hole basin mixer with pop-up waste - Brushed Durabronze (23kt Gold)

TARA

22 302 892



- 100mm projection
- pivotable spout 360°
- circular, air-enriched flow
- height of mixer 235 mm
- height up to aerator 134 mm
- hole diameter 35 mm
- rosette Ø 59 mm
- 2x screw-in M 10 x 1 pressure hose, leak-tested
- max. flow 7 l/min
- lead-free
- This product can help a building meet the requirements of Green Building Rating Systems, e.g. LEED®, BREEAM®, DGNB
- WRAS 1810003

Only suitable for basins with an overflow.

	Brushed Durabronze (23kt Gold)	22 302 892-28
	Chrome	22 302 892-00
	Brushed Platinum	22 302 892-06
	Platinum	22 302 892-08
	Dark Chrome	22 302 892-19
	Matte Black	22 302 892-33
	Brushed Bronze	22 302 892-42
	Brushed Champagne (22kt Gold)	22 302 892-46
	Champagne (22kt Gold)	22 302 892-47
	Brushed Chrome	22 302 892-93
	Brushed Dark Platinum	22 302 892-99

22 302 892
mm [inches]

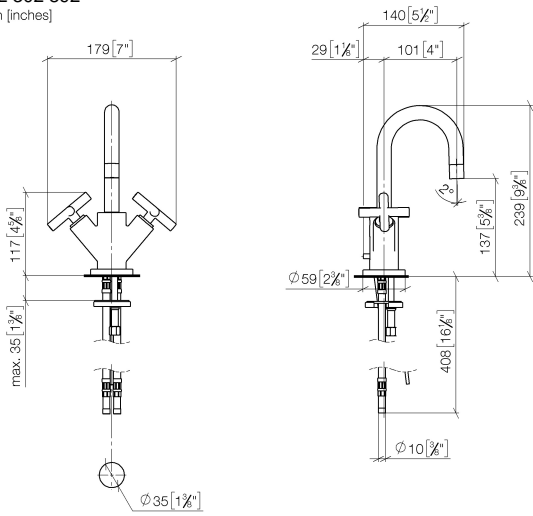

Flow rate chart

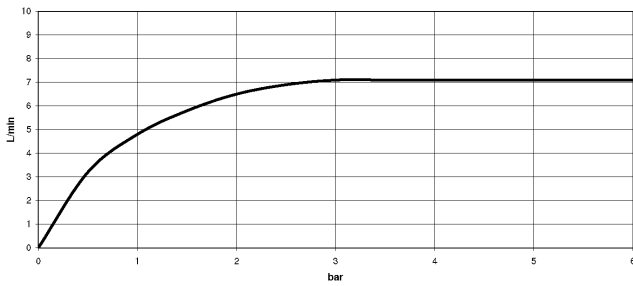

Codes & Standards

DIN 4109	EN 200	Executive Order no. 1007	ISO 3822
Scottish Water Byelaws	UK Water Supply Regulations	Ü-Zeichen	VA-Zeichen



TARA Single-hole basin mixer with pop-up waste - Brushed Durabronz (23kt Gold)

TARA

22 302 892

Certificates

LGA_18

GDV_0400

ETA_18

WRAS_1810



TARA Single-hole basin mixer with pop-up waste - Brushed Durabronz (23kt Gold)

TARA

22 302 892

Product version from 6/30/2009 to 5/27/2021

Product version from 5/27/2021

Parts for other finishes can be found here: [Chrome](#)

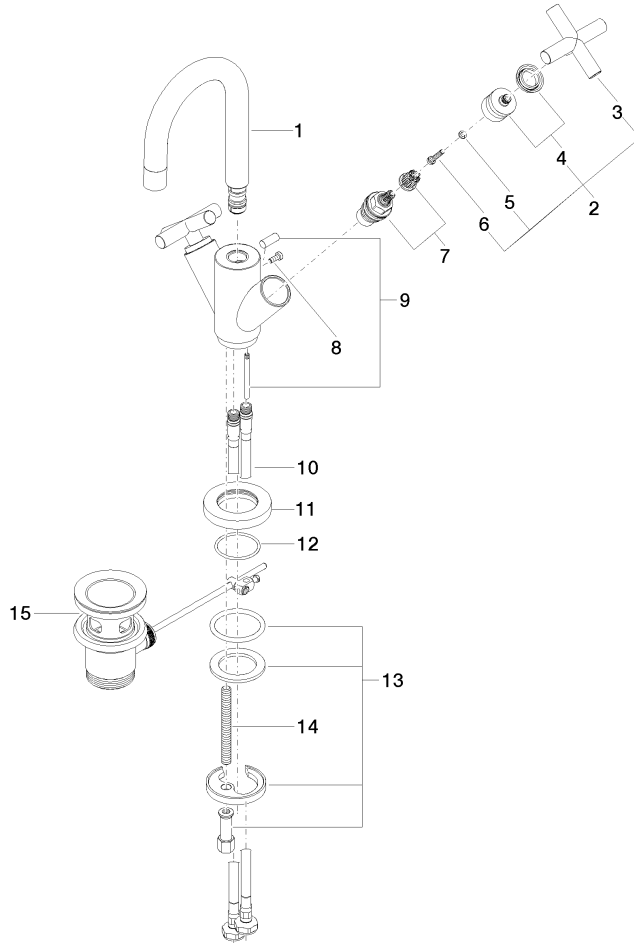



TARA Single-hole basin mixer with pop-up waste - Brushed Durabronze (23kt Gold)

TARA

22 302 892

Spare parts list

Product version from 6/30/2009 to 5/27/2021

Product version from 5/27/2021

No.	Item Number	Name	Quantity used	Delivery time
	90 28 22 215 01-28	spout	22	20