

Models/Modelos/Modèles
15770LF▲
Portwood™

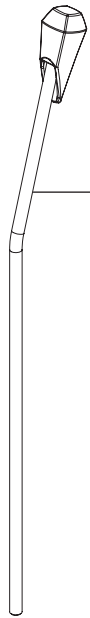

RP100503▲
 Lift Rod & Finial
 Barra de Alzar y Pomo
 Tige de Manoeuvre et
 Grain de la Tirette

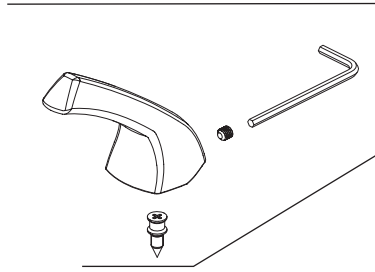

RP100750▲
 Handle Kit
 Conjunto de manija
 Montage de la manette



RP100751▲
 Cap & Bonnet Nut
 Casquillo y Tuerca del Bonete
 Embase et Chapeaux Fileté



RP63206
 Cartridge
 Cartouche
 Cartucho

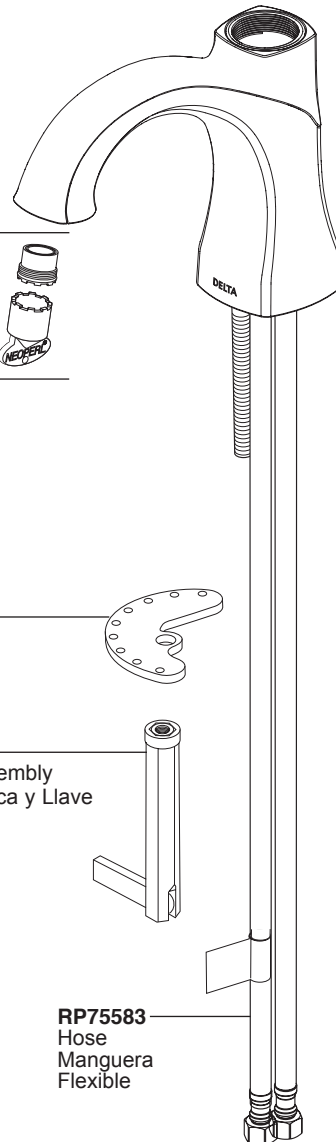

RP100753▲
 Flange & Gasket (1 Hole)
 Brida y Empaque (1 agujero)
 Bride et Joint (1 trou)

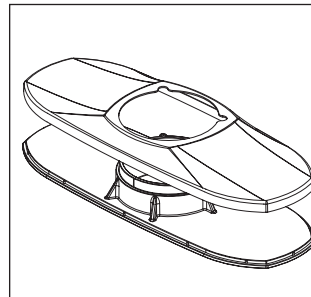
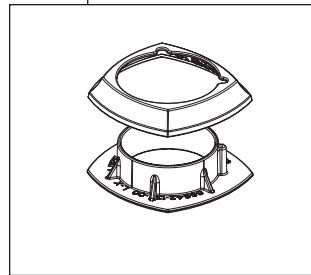

RP100752▲
 (Escutcheon optional, included)
 Escutcheon with Gasket (3 Hole)
 Chapetón y Empaque (3 agujeros)
 Boîtier et Joint (3 trous)

RP51345
RP51345-1.2
(1.2 GPM)
 Aerator & Wrench
 Aireador y Llave
 Aérateur et Clé



RP47029
 Bracket
 Abrazadera
 Support



RP47030
 Nut & Wrench Assembly
 Ensemble de Tuerca y Llave
 Écrou et clé

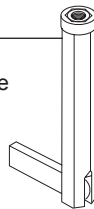

RP75583
 Hose
 Manguera
 Flexible

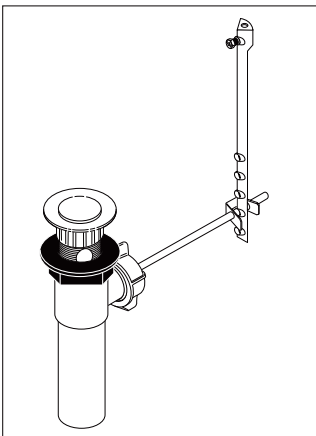

RP62472▲
 Plastic Pop-Up Less Lift Rod
 Desagüe Automático de Plástico
 Menos la Barra de Alzar
 Renvoi Mécanique en Plastique
 Sans la Tige de Manoeuvre

▲ Specify Finish
 Especificque el Acabado
 Précisez le Fini