

5194800

FINEZZA DUE Series

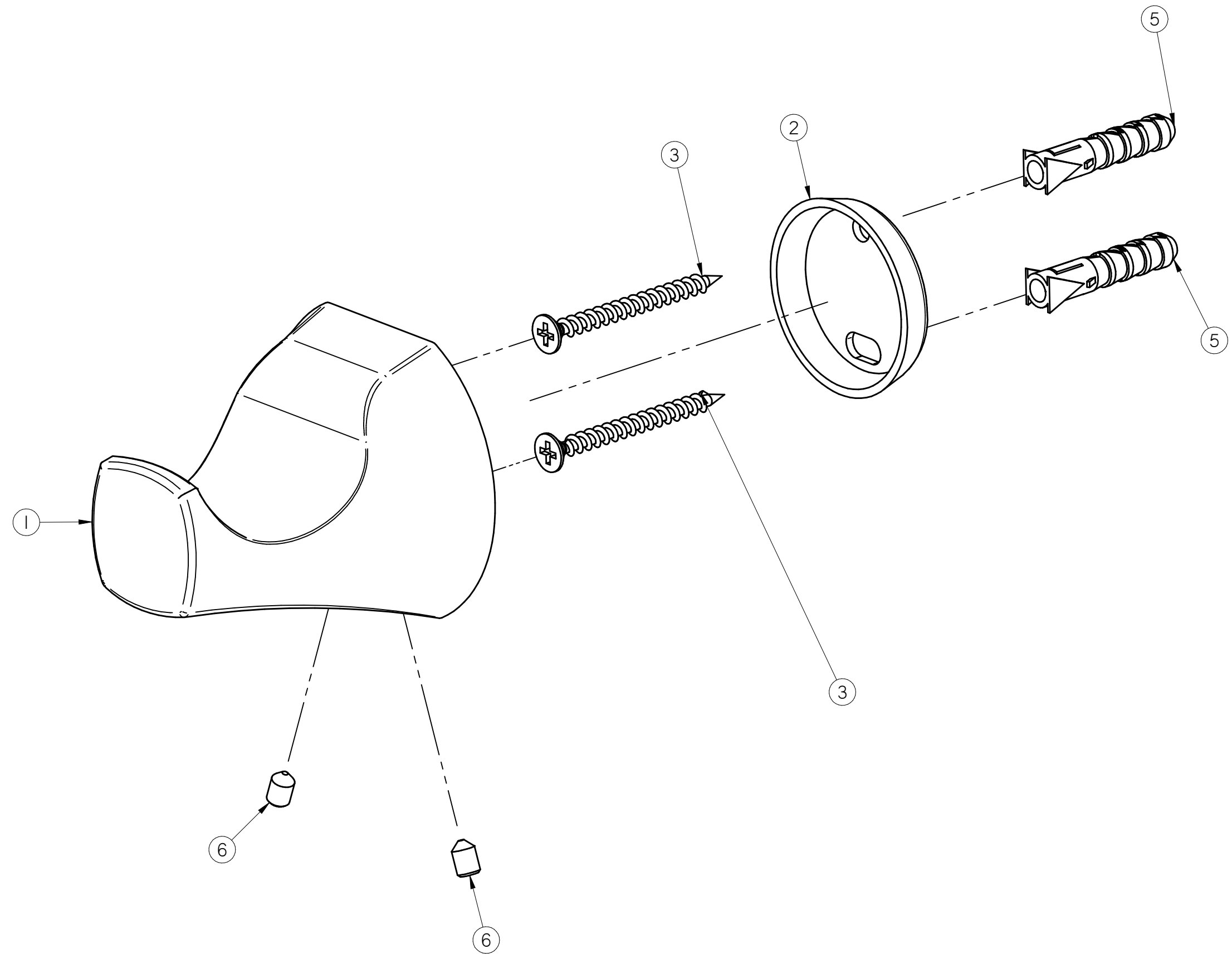

SOLID EDGE RESELLER COPY

GRAFF[®]
CUTTING EDGE DESIGN