

FS 01 Rondella larga in nylon con guarnizione di espanso, per il fissaggio di lastre in policarbonato

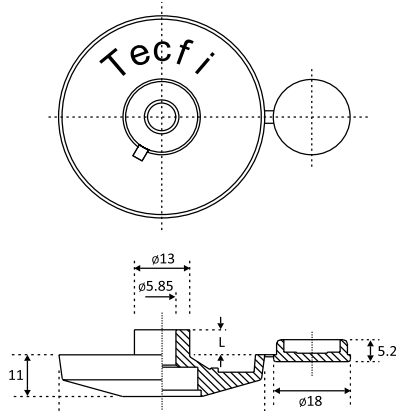

SCHEDA TECNICA



Rondella larga in poliammide (Nylon)

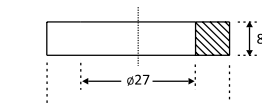

Guarnizione in polietilene espanso

L	Altezza gambo
Mat1	Materiale rondella
Mat2	Materiale guarnizione

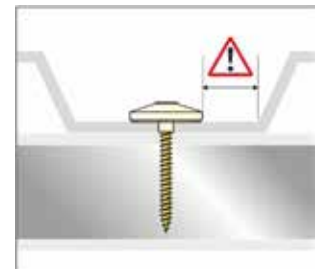
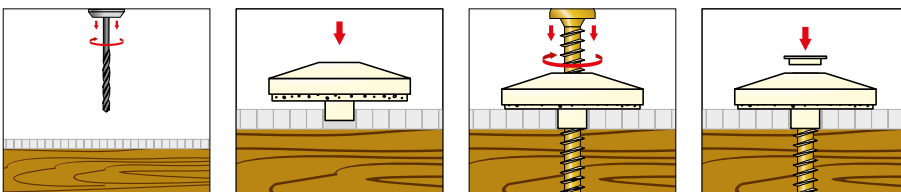

Attenzione:
lasciare un idoneo spazio tra la rondella e i fianchi della greca per far defluire l'acqua ed eventuali detriti

SCHEDA TECNICA **FS 01**

Codice Articolo	L (mm)	Mat1	Mat2
FS 01 00 050	-	Poliammide (Nylon)	Schiuma di polietilene espanso
FS 01 06 050	6		
FS 01 10 050	10		
FS 01 16 050	16		

FS 01 White large nylon washer with small cap and PE foam sealing gasket



TECHNICAL DATA SHEET

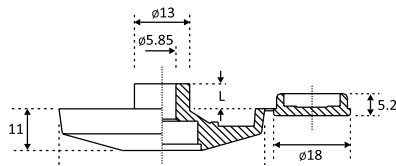
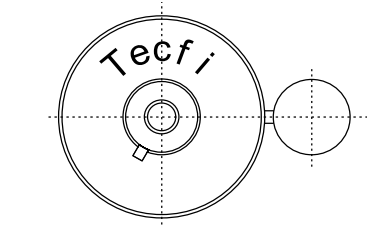

Polyamide (Nylon) large washer

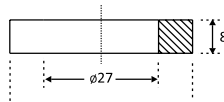

Polyethylene foam sealing gasket

L	Stank thickness
Mat1	Washer material
Mat2	Sealing gasket material

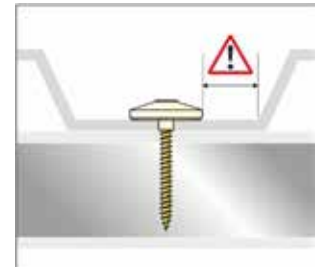
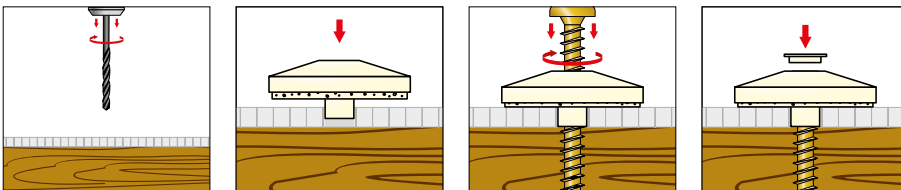

Warning:
Leave enough space to let pass rain
and debris

TECHNICAL DATA OF **FS 01**

Item code	L (mm)	Mat1	Mat2
FS 01 00 050	-	Polyamide (Nylon)	Polyethylene foam
FS 01 06 050	6		
FS 01 10 050	10		
FS 01 16 050	16		