

PowerLogic™ PM5100 series

User manual

EAV15105-EN09
12/2021



Legal Information

The Schneider Electric brand and any trademarks of Schneider Electric SE and its subsidiaries referred to in this guide are the property of Schneider Electric SE or its subsidiaries. All other brands may be trademarks of their respective owners.

This guide and its content are protected under applicable copyright laws and furnished for informational use only. No part of this guide may be reproduced or transmitted in any form or by any means (electronic, mechanical, photocopying, recording, or otherwise), for any purpose, without the prior written permission of Schneider Electric.

Schneider Electric does not grant any right or license for commercial use of the guide or its content, except for a non-exclusive and personal license to consult it on an "as is" basis. Schneider Electric products and equipment should be installed, operated, serviced, and maintained only by qualified personnel.

As standards, specifications, and designs change from time to time, information contained in this guide may be subject to change without notice.

To the extent permitted by applicable law, no responsibility or liability is assumed by Schneider Electric and its subsidiaries for any errors or omissions in the informational content of this material or consequences arising out of or resulting from the use of the information contained herein.

Safety information

Important information

Read these instructions carefully and look at the equipment to become familiar with the device before trying to install, operate, service, or maintain it. The following special messages may appear throughout this manual or on the equipment to warn of potential hazards or to call attention to information that clarifies or simplifies a procedure.



The addition of either symbol to a “Danger” or “Warning” safety label indicates that an electrical hazard exists which will result in personal injury if the instructions are not followed.



This is the safety alert symbol. It is used to alert you to potential personal injury hazards. Obey all safety messages that accompany this symbol to avoid possible injury or death.

DANGER

DANGER indicates a hazardous situation which, if not avoided, **will result in** death or serious injury.

Failure to follow these instructions will result in death or serious injury.

WARNING

WARNING indicates a hazardous situation which, if not avoided, **could result in** death or serious injury.

CAUTION

CAUTION indicates a hazardous situation which, if not avoided, **could result in** minor or moderate injury.

NOTICE

NOTICE is used to address practices not related to physical injury.

Please note

Electrical equipment should be installed, operated, serviced and maintained only by qualified personnel. No responsibility is assumed by Schneider Electric for any consequences arising out of the use of this material. A qualified person is one who has skills and knowledge related to the construction, installation, and operation of electrical equipment and has received safety training to recognize and avoid the hazards involved.

Notices

FCC

This equipment has been tested and found to comply with the limits for a Class B digital device, pursuant to part 15 of the FCC rules. These limits are designed to provide reasonable protection against harmful interference in a residential installation. This equipment generates, uses, and can radiate radio frequency energy and, if not installed and used in accordance with the instructions, may cause harmful interference to radio communications. However, there is no guarantee that the interference will not occur in a particular installation. If this equipment does cause harmful interference to radio or television reception, which can be determined by turning the equipment off and on, the user is encouraged to try to correct the interference by one or more of the following measures:

- Reorient or relocate the receiving antenna.
- Increase the separation between the equipment and receiver.
- Connect the equipment to an outlet on a circuit different from that to which the receiver is connected.
- Consult the dealer or an experienced radio/TV technician for help.

The user is cautioned that any changes or modifications not expressly approved by Schneider Electric could void the user's authority to operate the equipment.

This digital apparatus complies with CAN ICES-3 (B) /NMB-3(B).

About this manual

This manual discusses features of the PowerLogic™ PM5100 / PM5110 / PM5111 series power meter and provides installation and configuration instructions.

Throughout the manual, the term “meter” refers to all models of the PM5100. All differences between the models, such as a feature specific to one model, are indicated with the appropriate model number or description.

This manual assumes you have an understanding of power metering and are familiar with the equipment and power system in which your meter is installed.

This manual does not provide configuration information for advanced features where an expert user would perform advanced configuration. It also does not include instructions on how to incorporate meter data or perform meter configuration using energy management systems or software, other than ION Setup. ION Setup is a free configuration tool available for download from www.se.com.

The most up-to-date documentation about your meter is available for download from www.se.com.

Related documents

Document	Number
PM5100 series installation sheet	HRB32897

Table of Contents

Safety precautions	11
Meter overview	13
Features and options	13
Data display and analysis tools	14
Modbus command interface	15
Meter configuration	15
Hardware reference	16
Parts of the meter (rear view)	16
LED indicators on the display	16
Panel-mount meter mounting and wiring recommendations	17
Terminal covers	17
Meter wiring considerations	17
Communications connections	19
Meter display	21
Display overview	21
Default data display screen	21
Notification icons	22
Meter display language	22
Meter screen navigation	22
Meter screen menus overview	23
Menu tree	24
Data display screens	26
HMI setup screens	28
Setting up the display	29
Basic setup	30
Configuring basic setup parameters using the display	30
Configuring advanced setup parameters using the display	32
Setting up regional settings	32
Setting up the screen passwords	33
Lost user access	34
Setting the clock using the display	34
Communication	36
Serial communications	36
RS-485 port setup	36
Digital output	38
Digital output applications	38
Configuring digital output using the display	39
Energy pulsing	39
Alarms	42
Alarms overview	42
Available alarms	42
Unary alarms	42
Available unary alarms	42
Standard alarms	42
Example of over and under setpoint (standard) alarm operation	43
Alarm priorities	46
Alarm setup overview	47

Setting up alarms using the display	47
Unary alarm setup parameters	48
Standard (1-Sec) alarm setup parameters	48
LED alarm indicator	49
Alarm display and notification	49
Active alarms list and alarm history log	50
Viewing active alarm details using the display	50
Viewing alarm history details using the display	51
Viewing alarms counters using the display	51
Acknowledging high-priority alarms using the display	51
Resetting alarms using ION Setup	51
Measurements and calculations	52
Real-time readings	52
Energy	52
Configuring the energy scaling using ION Setup	52
Preset energy	53
Configuring the preset energy using ION Setup	53
Min/max values	54
Demand	54
Setting up demand calculations	57
Power factor (PF)	58
Timers	62
Resets	63
Performing global resets using the display	63
Performing single resets using the display	63
Power quality	65
Power quality measurements	65
Harmonics overview	65
Total harmonic distortion %	65
Total demand distortion	65
Harmonic content calculations	65
THD% calculations	66
thd calculations	66
TDD calculations	66
Viewing harmonics using the display	66
Viewing TDD using the display	67
Viewing THD/thd using the display	67
Maintenance	69
Maintenance overview	69
Power meter memory	69
Firmware version, model and serial number	69
Diagnostics information	71
Control power (auxiliary power) interruption event	71
Acknowledging control power (auxiliary power) interruption event using the display	71
Troubleshooting	72
Technical assistance	74
Verifying accuracy	75
Overview of meter accuracy	75
Accuracy test requirements	75

Energy pulsing.....	76
Meter settings for accuracy testing.....	76
Verifying accuracy test.....	76
Accuracy verification test points.....	79
Energy pulsing considerations.....	79
VT and CT considerations.....	79
Total power limits.....	80
Typical sources of test errors.....	80
MID compliance.....	81
Protected setup parameters and functions.....	81
Locking or unlocking the meter.....	81
Setting up the lock password.....	82
Device specifications.....	83
China Standard Compliance.....	87

Safety precautions

Installation, wiring, testing and service must be performed in accordance with all local and national electrical codes.

⚠️⚠️ DANGER
<p>HAZARD OF ELECTRIC SHOCK, EXPLOSION, OR ARC FLASH</p> <ul style="list-style-type: none"> • Apply appropriate Personal Protective Equipment (PPE) and follow safe electrical work practices. See NFPA 70E, CSA Z462 or other local standards. • Turn off all power supplying this device and the equipment in which it is installed before working on or in the equipment. • Always use a properly rated voltage sensing device to confirm that all power is off. • Follow guidelines in the Wiring section of the related Installation Sheet. • Assume communications and I/O wiring are hazardous live until determined otherwise. • Do not exceed the maximum ratings of this device. • Do not short secondary terminals of Voltage Transformer (VT). • Do not open secondary terminals of Current Transformer (CT). • Ground secondary circuit of CTs. • Do not use the data from the meter to confirm power is off. • Replace all devices, doors and covers before turning on power to this equipment. <p>Failure to follow these instructions will result in death or serious injury.</p>

NOTE: See IEC 60950-1 for more information on communications and I/O wiring connected to multiple devices.

⚠️ WARNING
<p>UNINTENDED OPERATION</p> <ul style="list-style-type: none"> • Do not use this device for critical control or protection of persons, animals, property or equipment. • Do not use this device if a wrench icon  appears on the top left corner of the display screen or if the value under Meter Status is not "OK". <p>Failure to follow these instructions can result in death, serious injury, or equipment damage.</p>

▲ WARNING**POTENTIAL COMPROMISE OF SYSTEM AVAILABILITY, INTEGRITY, AND CONFIDENTIALITY**

- Change default passwords/passcodes to help prevent unauthorized access to device settings and information.
- Disable unused ports/services and default accounts, where possible, to minimize pathways for malicious attacks.
- Place networked devices behind multiple layers of cyber defenses (such as firewalls, network segmentation, and network intrusion detection and protection).
- Use cybersecurity best practices (for example: least privilege, separation of duties) to help prevent unauthorized exposure, loss, modification of data and logs, interruption of services, or unintended operation.

Failure to follow these instructions can result in death, serious injury, or equipment damage.

Meter overview

Features and options

The PowerLogic™ PM5100 power and energy meters offer value for the demanding needs of your energy monitoring and cost management applications.

	PM5100	PM5110	PM5111
Fast installation, panel mount with integrated display	✓	✓	✓
Accuracy IEC 61557-12	CI 0.5S	CI 0.5S	CI 0.5S
Display Backlit LCD, multilingual, bar graphs, 6 lines, 4 concurrent values	✓	✓	✓
Power and energy metering: 3-phase voltage, current, power, demand, energy, frequency, power factor	✓	✓	✓
Power quality analysis: THD, thd, TDD	✓	✓	✓
Power quality analysis: Harmonics, individual (odd) up to	15th	15th	15th
I/Os	1DO	1DO	1DO
Alarms	33	33	33
Setpoint response time, seconds	1	1	1
Communications: Serial ports with Modbus protocol	—	1	1
MID-ready compliance	—	—	✓

Functions and characteristics

General

Use on LV and MV systems	✓
Basic metering with THD and min/max readings	✓

Instantaneous rms values

Current (per phase and neutral)	✓
Voltage (total, per phase L-L and L-N)	✓
Frequency	✓
Real, reactive, and apparent power (Total and per phase)	Signed, Four Quadrant
True Power Factor (Total and per phase)	Signed, Four Quadrant
Displacement PF (Total and per phase)	Signed, Four Quadrant
% Unbalanced I, V L-N, V L-L	✓

Energy values

Accumulated Active, Reactive and Apparent Energy ¹	Received/Delivered; Net and absolute
---	--------------------------------------

Demand values

Current average ¹	Present, Last, Predicted, Peak, and Peak Date Time
Active power ¹	Present, Last, Predicted, Peak, and Peak Date Time

1. Stored in non-volatile memory

Demand values (Continued)

Reactive power ²	Present, Last, Predicted, Peak, and Peak Date Time
Apparent power ²	Present, Last, Predicted, Peak, and Peak Date Time
Demand calculation (Sliding, fixed and rolling block, thermal methods)	✓
Synchronization of the measurement window to input, communication command or internal clock	✓
Configurable demand intervals	✓

Power quality measurements

THD, thd (Total Harmonic Distortion) I, V L-N, V L-L per phase	I, V L-N, V L-L
TDD (Total Demand Distortion)	✓
Individual harmonics (odds)	15th

Other measurements

Operating timer ²	✓
Load timer ²	✓
Alarm counters and alarm logs	✓

Data recording

Min/max of instantaneous values, plus phase identification ²	✓
Alarms with 1 s timestamping ²	✓
Min/max log	✓

Digital output

Digital output	1 (kWh only)
Timestamp resolution in seconds	1

Data display and analysis tools

Power Monitoring Expert

EcoStruxure™ Power Monitoring Expert is a complete supervisory software package for power management applications.

The software collects and organizes data gathered from your facility's electrical network and presents it as meaningful, actionable information via an intuitive web interface.

Power Monitoring Expert communicates with devices on the network to provide:

- Real-time monitoring through a multi-user web portal
- Trend graphing and aggregation
- Power quality analysis and compliance monitoring
- Preconfigured and custom reporting

See the EcoStruxure™ Power Monitoring Expert online help for instructions on how to add your device into its system for data collection and analysis.

². Stored in non-volatile memory

Power SCADA Operation

EcoStruxure™ Power SCADA Operation is a complete real-time monitoring and control solution for large facility and critical infrastructure operations.

It communicates with your device for data acquisition and real-time control. You can use Power SCADA Operation for:

- System supervision
- Real-time and historical trending, event logging
- PC-based custom alarms

See the EcoStruxure™ Power SCADA Operation online help for instructions on how to add your device into its system for data collection and analysis.

Modbus command interface

Most of the meter's real-time and accumulated data, as well as basic configuration and setup of meter features, can be accessed and programmed using a Modbus command interface as published in Modbus register list.

This is an advanced procedure that should only be performed by users with advanced knowledge of Modbus, their meter, and the power system being monitored. For further information on the Modbus command interface, contact Technical Support.

See your meter's Modbus register list at www.se.com for the Modbus mapping information and basic instructions on command interface.

Meter configuration

Meter configuration can be performed through the display or PowerLogic™ ION Setup.

ION Setup is a meter configuration tool that can be downloaded for free at www.se.com.

See the ION Setup online help or in the ION Setup device configuration guide. To download a copy, go to www.se.com and search for ION Setup device configuration guide.

Hardware reference

Parts of the meter (rear view)

Most of the input, output and communication ports are located on the back of the meter.

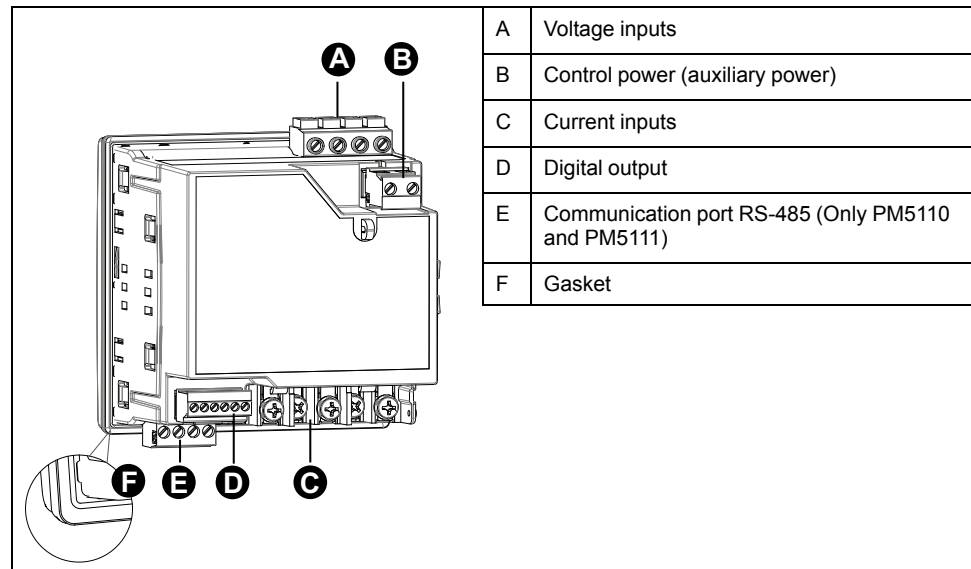

LED indicators on the display

The display has two LED indicators.

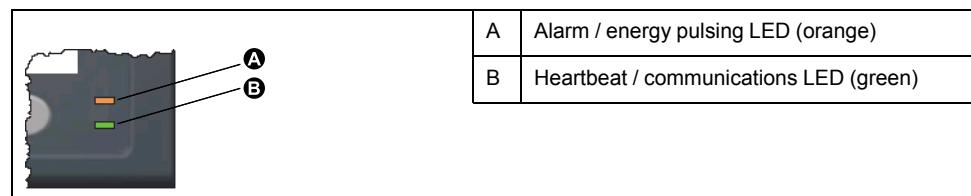

Alarm / energy pulsing LED

The alarm / energy pulsing LED can be configured for alarm notification or energy pulsing.

When configured for alarm notification, this LED flashes when a high, medium or low priority alarm is active. The LED provides a visual indication of an active alarm condition or an inactive but unacknowledged high priority alarm.

When configured for energy pulsing, this LED flashes at a rate proportional to the amount of energy consumed. This is typically used to verify the power meter's accuracy.

Heartbeat / serial communications LED

The heartbeat / serial communications LED blinks to indicate the meter's operation and serial Modbus communications status.

The LED blinks at a slow, steady rate to indicate the meter is operational. The LED flashes at a variable, faster rate when the meter is communicating over a Modbus serial communications port.

You cannot configure this LED for other purposes.

NOTE: A heartbeat LED that remains lit and does not blink (or flash) can indicate a problem. In this case, power down the meter and reapply power. If the LED still does not blink or flash, contact Technical Support.

Panel-mount meter mounting and wiring recommendations

There are supplemental mounting and wiring recommendations that apply to panel-mount meters.

- The meter is intended to be mounted inside a ¼-DIN panel cutout.
- Inspect the gasket (installed around the perimeter of the display) and make sure it is secured properly and not damaged.
- The meter retainer clips, located on either side of the meter base and used to secure the meter in the panel, do not usually require any tools to install.

Terminal covers

The voltage and current terminal covers help prevent tampering with the meter's voltage and current measurement inputs.

The terminal covers enclose the terminals, the conductor fixing screws and a length of the external conductors and their insulation. The terminal covers are secured by tamper-resistant meter seals.

These covers are included for meter models where sealable voltage and current covers are required to comply with revenue or regulatory standards.

The meter terminal covers must be installed by a qualified installer.

Refer to your meter's installation sheet or the instructions that came with your terminal covers for instructions on installing the terminal covers.

Meter wiring considerations

Direct connect voltage limits

You can connect the meter's voltage inputs directly to the phase voltage lines of the power system if the power system's line-to-line or line-to-neutral voltages do not exceed the meter's direct connect maximum voltage limits.

The meter's voltage measurement inputs are rated by the manufacturer for up to 400 V L-N / 690 V L-L. However, the maximum voltage allowed for direct connection may be lower, depending on the local electrical codes and regulations. In US and Canada the maximum voltage on the meter voltage measurement inputs may not exceed 347 V L-N / 600 V L-L.

If your system voltage is greater than the specified direct connect maximum voltage, you must use VTs (voltage transformers) to step down the voltages.

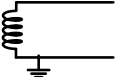
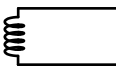
Power system description	Meter setting	Symbol	Direct connect maximum (UL)	Direct connect maximum (IEC)	# of VTs (if required)
Single-phase 2-wire line-to-neutral	1PH2W LN		347 V L-N	400 V L-N	1 VT
Single-phase 2-wire line-to-line	1PH2W LL		600 V L-L	600 V L-L	1 VT

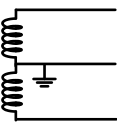
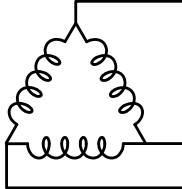
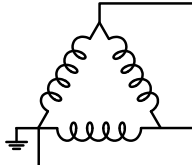
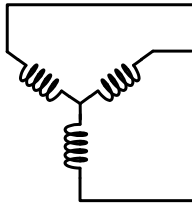
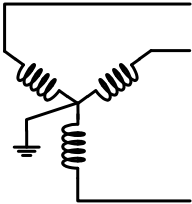
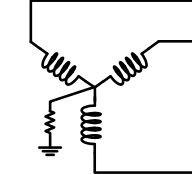
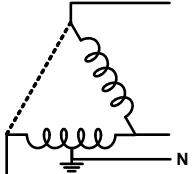
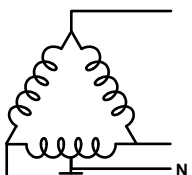
Power system description	Meter setting	Symbol	Direct connect maximum (UL)	Direct connect maximum (IEC)	# of VTs (if required)
Single-phase 3-wire line-to-line with neutral	1PH3W LL with N		347 V L-N / 600 V L-L	400 V L-N / 690 V L-L	2 VT
3-phase 3-wire Delta ungrounded	3PH3W Dlt Ungnd		600 V L-L	600 V L-L	2 VT
3-phase 3-wire Delta corner grounded	3PH3W Dlt Cmr Gnd		600 V L-L	600 V L-L	2 VT
3-phase 3-wire Wye ungrounded	3PH3W Wye Ungnd		600 V L-L	600 V L-L	2 VT
3-phase 3-wire Wye grounded	3PH3W Wye Gnd		600 V L-L	600 V L-L	2 VT
3-phase 3-wire Wye resistance-grounded	3PH3W Wye Res Gnd		600 V L-L	600 V L-L	2 VT
3-phase 4-wire open Delta center-tapped	3PH4W Opn Dlt Ctr Tp		240 V L-N / 415 V L-N / 480 V L-L	240 V L-N / 415 V L-N / 480 V L-L	3 VT
3-phase 4-wire Delta center-tapped	3PH4W Dlt Ctr Tp		240 V L-N / 415 V L-N / 480 V L-L	240 V L-N / 415 V L-N / 480 V L-L	3 VT

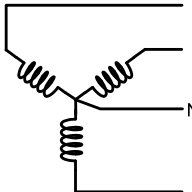
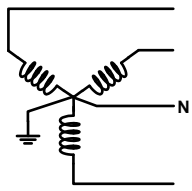
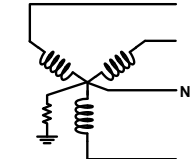
Power system description	Meter setting	Symbol	Direct connect maximum (UL)	Direct connect maximum (IEC)	# of VTs (if required)
3-phase 4-wire ungrounded Wye	3PH4W Wye Ungnd		347 V L-N / 600 V L-L	347 V L-N / 600 V L-L	3 VT or 2 VT
3-phase 4-wire grounded Wye	3PH4W Wye Gnd		347 V L-N / 600 V L-L	400 V L-N / 690 V L-L	3 VT or 2 VT
3-phase 4-wire resistance-grounded Wye	3PH4W Wye Res Gnd		347 V L-N / 600 V L-L	347 V L-N / 600 V L-L	3 VT or 2 VT

Balanced system considerations

In situations where you are monitoring a balanced 3-phase load, you may choose to connect only one or two CTs on the phase(s) you want to measure, and then configure the meter so it calculates the current on the unconnected current input(s).

NOTE: For a balanced 4-wire Wye system, the meter's calculations assume that there is no current flowing through the neutral conductor.

Balanced 3-phase Wye system with 2 CTs

The current for the unconnected current input is calculated so that the vector sum for all three phases equal zero.

Balanced 3-phase Wye or Delta system with 1CT

The currents for the unconnected current inputs are calculated so that their magnitude and phase angle are identical and equally distributed, and the vector sum for all three phase currents equal zero.

NOTE: You must always use 3 CTs for 3-phase 4-wire center-tapped Delta or center-tapped open Delta systems.

Communications connections

RS-485 wiring

Connect the devices on the RS-485 bus in a point-to-point configuration, with the (+) and (-) terminals from one device connected to the corresponding (+) and (-) terminals on the next device.

RS-485 cable

Use a shielded 2 twisted pair or 1.5 twisted pair RS-485 cable to wire the devices. Use one twisted pair to connect the (+) and (-) terminals, and use the other insulated wire to connect the C terminals

The total distance for devices connected on an RS-485 bus should not exceed 1200 m (4000 ft).

RS-485 terminals

C	Common. This provides the voltage reference (zero volts) for the data plus and data minus signals
	Shield. Connect the bare wire to this terminal to help suppress signal noise that may be present. Ground the shield wiring at one end only (either at the master or the last slave device, but not both).
-	Data minus. This transmits/receives the inverting data signals.
+	Data plus. This transmits/receives the non-inverting data signals.

NOTE: If some devices in your RS-485 network do not have the Common terminal, use the bare wire in the RS-485 cable to connect the Common terminal from the meter to the shield terminal on the devices that do not have the Common terminal.

Meter display

Display overview

The display lets you use the meter to perform various tasks such as setting up the meter, displaying data screens, acknowledging alarms, or performing resets.

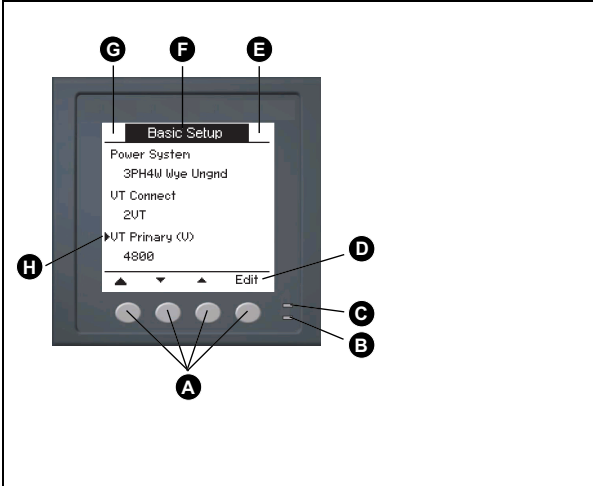

A	Navigation / menu selection buttons
B	Heartbeat / communications LED (green)
C	Alarm / energy pulsing LED (orange)
D	Navigation symbols or menu options
E	Right notification area
F	Screen title
G	Left notification area
H	Cursor

Default data display screen

The default data display screen varies depending on the meter model.

The **Summary** screen is the default screen for all meter models except PM5111.

The **Summary** screen displays real-time values for average voltage and current (Vavg, Iavg), total power (Ptot) and energy consumption (E Del).

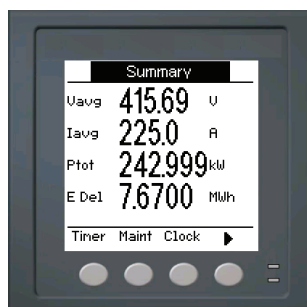



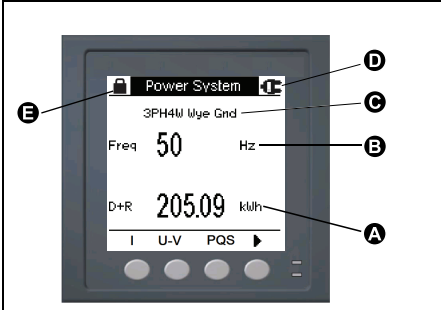

The **Power System** screen is the default screen for PM5111 meter model.



A	Accumulated real energy (delivered + received)
B	System frequency
C	Power system setting
D	Control power (auxiliary power) interruption event icon
E	Locked / unlocked icon

Notification icons

To alert you about meter state or events, notification icons appear at the top left or top right corner of the display screen.

Icon	Description
	The wrench icon indicates that the power meter requires maintenance.
	The alarm icon indicates an alarm condition has occurred.
	The blinking heartbeat icon indicates that the power meter is in normal operating condition.
 (Displayed only in MID compliance meter models)	The icon indicates that a control power (auxiliary power) interruption event has occurred.

Meter display language

You can configure the meter to display the information on the display screen in one of several languages.

The following languages are available:

- English
- French
- Spanish
- German
- Italian
- Portuguese
- Russian
- Chinese

Meter screen navigation

The meter's buttons and display screen allow you to navigate data and setup screens, and to configure the meter's setup parameters.

A. Press the button below the appropriate menu to view that screen

B. Press the right arrow to view more screens

C. In setup mode, a small right arrow indicates the selected option

D. In setup mode, a small down arrow indicates that there are additional parameters to display. The down arrow disappears when there are no more parameters to display.

E. In setup mode, press the button under **Edit** to change that setting. If the item is read-only, cannot be configured with the meter's existing setup, or can only be configured using software, **Edit** disappears.

Navigation symbols

Navigation symbols indicate the functions of the associated buttons on your meter's display.

Symbol	Description	Actions
▶	Right arrow	Scroll right and display more menu items or move cursor one character to the right
▲	Up arrow	Exit screen and go up one level
▼	Small down arrow	Move cursor down the list of options or display more items below
▲	Small up arrow	Move cursor up the list of items or display more items above
◀	Left arrow	Move cursor one character to the left
+	Plus sign	Increase the highlighted value or show the next item in the list.
-	Minus sign	Show the previous item in the list

When you reach the last screen, press the right arrow again to cycle through the screen menus.

Meter screen menus overview

All meter screens are grouped logically, according to their function.

You can access any available meter screen by first selecting the Level 1 (top level) screen that contains it.

Level 1 screen menus - IEEE title [IEC title]

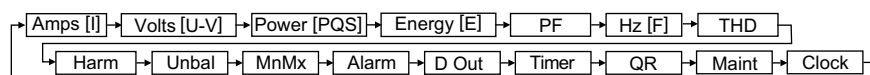

Menu tree

Use the menu tree to navigate to the parameter or setting you want to view or configure.

Level 1, 2 and 3 meter screens - IEEE title [IEC title]

The image below summarizes the available meter screens (IEEE menus shown, with the corresponding IEC menus in parentheses).

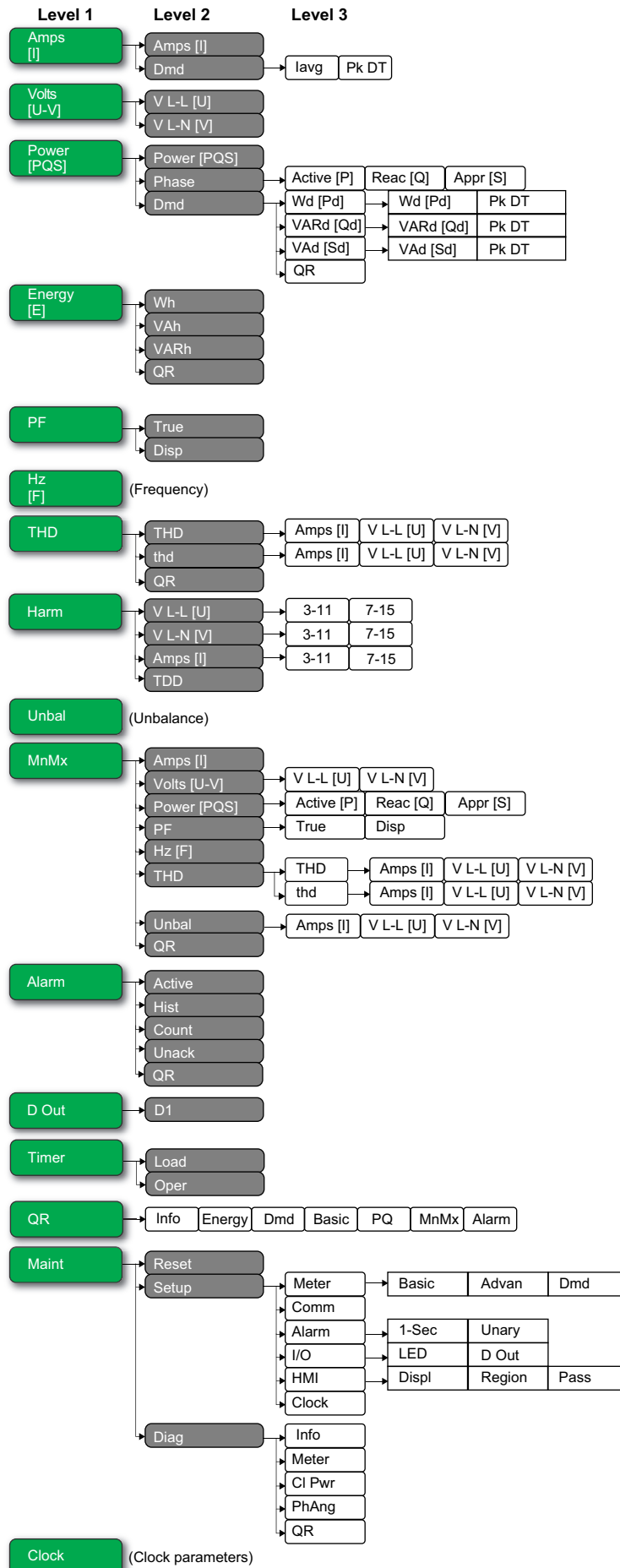

Data display screens

The meter display screens allow you to view meter values and configure settings.

The titles listed are for the HMI mode in IEEE, with the corresponding titles in IEC mode in square brackets [].

- Bulleted items indicate subscreens and their descriptions.

Amps [I]

Amps [I]	Instantaneous current measurements for each phase and calculated neutral (In) or calculated ground current (I _g) based on the meter wiring type.
Dmd	Summary of peak current demand values at the last demand interval.
<ul style="list-style-type: none"> • Iavg • Pk DT 	<ul style="list-style-type: none"> • Real-time demand (Pres), peak demand (Peak) and predicted demand (Pred) for the present interval. Average demand for the previous (Last) interval. • Date and timestamp for the peak demand readings.

Volts [U-V]

V L-L [U]	Line-to-line voltage for each phase.
V L-N [V]	Line-to-neutral voltage for each phase.

Power [PQS]

Power [PQS]	Summary of real-time power consumption values for total active power in kW (Total [P _{tot}]), total reactive power in kVAR (Total [Q _{tot}]), and total apparent power in kVA (Total [S _{tot}]).
Phase	Per phase (A [P1], B [P2], C [P3]) and total (Total [P _{tot}]) power values for active power in kW, reactive power in kVAR and apparent power in kVA.
<ul style="list-style-type: none"> • Active [P], Reac [Q], Appr [S] 	
Dmd	Summary of peak power demand values in the previous (Last) demand interval period for active power in kW, reactive power in kVAR and apparent power in kVA.
<ul style="list-style-type: none"> • Wd [Pd], VARd [Qd], VAd [Sd] <ul style="list-style-type: none"> ◦ Pk DT • QR 	<ul style="list-style-type: none"> • Total power demand values in the previous (Last) demand interval for active power demand (Wd [P]), reactive power demand (VARd [Q]) and apparent power demand (VAd [S]). Displays demand values for the present demand (Pres) interval, demand for the previous demand (Last) interval period, predicted demand (Pred) based on the current power consumption rate, and the recorded peak power demand (Peak) value. <ul style="list-style-type: none"> ◦ Date and timestamp for the peak power demand (Peak) value. • Power demand parameters embedded in QR code format.

Energy [E]

Wh, VAh, VARh	Delivered (Del), received (Rec), delivered plus received (D+R) and delivered minus received (D-R) accumulated values for active energy (Wh), apparent energy (VAh) and reactive energy (VARh).
QR	Energy parameters (Wh, VAh, VARh, and multi-tariff) embedded in QR code format.

PF

True	Per phase and total true power factor values and sign.
Disp	Per phase and total displacement power factor values and sign.

Hz [F]

Frequency (Freq). This page also displays average voltage (Vavg), average current (Iavg) and total power factor (PF) values.
--

THD

THD • Amps [I], V L-L [U], V L-N [V]	THD (ratio of harmonic content to the fundamental) for current, line-to-line voltage and line-to-neutral voltage.
thd • Amps [I], V L-L [U], V L-N [V]	thd (ratio of harmonic content to the rms value of total harmonic content) for current, line-to-line voltage and line-to-neutral voltage.
QR	Power quality parameters (THD and thd) embedded in QR code format.

Harm

V L-L [U] • 3-11, 7-15	Line-to-line voltage harmonics data: Numeric magnitude and angle for the fundamental harmonic, and graphical representation of harmonics for the 3rd to 11th and 7th to 15th odd harmonics for each line-to-line phase voltage.
V L-N [V] • 3-11, 7-15	Line-to-neutral voltage harmonics data: Numeric magnitude and angle for the fundamental harmonic, and graphical representation of harmonics for the 3rd to 11th and 7th to 15th odd harmonics for each line-to-neutral phase voltage.
Amps [I] • 3-11, 7-15	Current harmonics data: Numeric magnitude and angle for the fundamental harmonics, and graphical representation of harmonics for the 3rd to 11th and 7th to 15th odd harmonics for each phase current.
TDD	Total demand distortion each phase voltage.

Unbal

Percent unbalance readings for line-to-line voltage (V L-L [U]), line-to-neutral voltage (V L-N [V]) and current (Amps [I]).
--

MnMx

Amps [I]	Summary of minimum and maximum values for phase current.
Volts [U-V] • V L-L [U], V L-N [V]	Summary of minimum and maximum values for line-to-line voltage and line-to-neutral voltage.
Power [PQS] • Active [P], Reac [Q], Appr [S]	Minimum and maximum values for active, reactive, and apparent power.
PF • True, Disp	Minimum and maximum values for true and displacement PF and PF sign.
Hz [F]	Minimum and maximum values for frequency.
THD • THD, thd • Amps [I], V L-L [U], V L-N [V]	<ul style="list-style-type: none"> • Minimum and maximum values for total harmonic distortion (THD or thd). <ul style="list-style-type: none"> • THD or thd minimum and maximum values for phase or neutral current, line-to-line voltage and line-to-neutral voltage.
Unbal • Amps [I], V L-L [U], V L-N [V]	Minimum and maximum values for current unbalance, line-to-line voltage unbalance and line-to-neutral voltage unbalance.
QR	Minimum and maximum values (phase current, line-to-line voltage, line-to-neutral voltage, power (PQS), PF, frequency, power quality and Unbal) embedded in QR code format.

Alarm

Active, Hist, Count, Unack	Lists all active alarms (Active), past alarms (Hist), the total number of times each standard alarm was tripped (Count), and all unacknowledged alarms (Unack).
QR	Alarm parameters (active, past alarms, the total number of times each standard alarm was tripped, unacknowledged) embedded in QR code format.

D Out

D1	Current status (OFF or Energy pulsing) of the selected digital output.
-----------	--

Timer

Load	Real-time counter that keeps track of the total number of days, hours, minutes and seconds an active load is connected to the meter inputs.
Oper	Real-time counter for the total number of days, hours, minutes and seconds the meter has been powered.

QR

Meter info details, energy parameters, power demand parameters, basic parameter values (current, voltage and power), power quality parameters, minimum / maximum values (phase current, line-to-line voltage, line-to-neutral voltage, power (PQS), PF, frequency, power quality and Unbal) and alarm parameters embedded in QR code format.
--

Maint

Reset	Screens to perform global or single resets.
Setup <ul style="list-style-type: none"> • Meter <ul style="list-style-type: none"> ◦ Basic ◦ Advan ◦ Dmd • Comm • Alarm <ul style="list-style-type: none"> ◦ 1-Sec, Unary • I/O <ul style="list-style-type: none"> ◦ LED ◦ D Out • HMI <ul style="list-style-type: none"> ◦ Displ, Region, Pass • Clock 	<ul style="list-style-type: none"> • Meter configuration screens. <ul style="list-style-type: none"> ◦ Screens to define the power system and power system components/elements. ◦ Screens to set up the active load timer and define the peak demand current for inclusion in TDD calculations. ◦ Screens to set up power demand, current demand and input metering demand. • Screen to set up serial communication. • Screens to set up standard (1-Sec) and unary alarms. • Screens to set up the alarm / energy pulsing LED and digital output. • Screens to configure display settings, edit regional settings, and set up meter display access passwords. • Screens to set up the meter date and time.
Diag <ul style="list-style-type: none"> • Info • Meter • CI Pwr • PhAng • QR 	<p>Diagnostic screens provide meter information, status and event data for troubleshooting.</p> <ul style="list-style-type: none"> • The Info screen displays the meter model, serial number, date of manufacture, firmware version (including OS - Operating System and RS - Reset System), language version, and OS CRC (Cyclic Redundancy Check). The OS CRC value is a number (Hexadecimal format) that identifies the uniqueness between different OS firmware versions. • Displays the meter status. • Non-MID meter models : The CI Pwr screen displays how many times the meter lost control power, and the date and time of its last occurrence. • MID meter models : The CI Pwr screen displays how many times the meter lost control power (auxiliary power), and the last power up and power down events with the timestamp. • The PhAng screen displays the angle between voltage and current for all three phases of the power system the meter is monitoring. • Meter info details embedded in QR code format.

Clock

Meter date and time (local or GMT).

HMI setup screens

You can configure the meter's display using the HMI setup screens.

The HMI (human-machine interface) setup screens allow you to:

- control the general appearance and behavior of the display screens,
- change the regional settings,

- change the meter passwords,
- enable or disable the QR code feature for accessing meter data.

See the *Meter Insights QR code feature quick start guide* for more information on accessing meter data using QR codes.

Setting up the display

You can change the display screen's settings, such as contrast, display and backlight timeout and QR code display.

1. Navigate to **Maint > Setup**.
2. Enter the setup password (default is "0"), then press **OK**.
3. Navigate to **HMI > Displ**.
4. Move the cursor to point to the parameter you want to modify, then press **Edit**.
5. Modify the parameter as required, then press **OK**.
6. Move the cursor to point to the next parameter you want to modify, press **Edit**, make your changes, then press **OK**.
7. Press the up arrow to exit.
8. Press **Yes** to save your changes.

Display settings available using the display

Parameter	Values	Description
Contrast	1 - 9	Increase or decrease the value to increase or decrease the display contrast.
Bcklght Timeout (min)	0 - 60	Set how long (in minutes) before the backlight turns off after a period of inactivity. Setting this to "0" disables the backlight timeout feature (i.e., backlight is always on).
Screen Timeout (min)	0 - 60	Set how long (in minutes) before the screen turns off after a period of inactivity. Setting this to "0" disables the screen timeout feature (i.e., display is always on).
QR Code	Enable, Disable	Set whether or not QR codes with embedded data are available on the display.

See the *Meter Insights QR code feature quick start guide* for more information on accessing meter data using QR codes.

To configure the display using ION Setup, see the section for your meter in the ION Setup online help or in the ION Setup device configuration guide, available for download at www.se.com.

Basic setup

Configuring basic setup parameters using the display

You can configure basic meter parameters using the display.

Proper configuration of the meter's basic setup parameters is essential for accurate measurement and calculations. Use the Basic Setup screen to define the electrical power system that the meter is monitoring.

If standard (1-sec) alarms have been configured and you make subsequent changes to the meter's basic setup, all alarms are disabled to prevent undesired alarm operation.

⚠ WARNING

UNINTENDED EQUIPMENT OPERATION

- Verify all standard alarms settings are correct and make adjustments as necessary.
- Re-enable all configured alarms.

Failure to follow these instructions can result in death, serious injury, or equipment damage.

After saving the changes, confirm all configured standard alarm settings are still valid, reconfigure them as required, and re-enable the alarms.

1. Navigate to **Maint > Setup**.
2. Enter the setup password (default is "0"), then press **OK**.
3. Navigate to **Meter > Basic**.
4. Move the cursor to point to the parameter you want to modify, then press **Edit**.
5. Modify the parameter as required, then press **OK**.
6. Move the cursor to point to the next parameter you want to modify, press **Edit**, make your changes, then press **OK**.

7. Press the up arrow to exit, then press **Yes** to save your changes.

Basic setup parameters available using the display

Values	Description
Power System	
Select the power system type (power transformer) the meter is wired to.	
1PH2W LN	Single-phase 2-wire line-to-neutral
1PH2W LL	Single-phase 2-wire line-to-line
1PH3W LL with N	Single-phase 3-wire line-to-line with neutral
3PH3W Dlt Ungnd	3-phase 3-wire ungrounded delta
3PH3W Dlt Crnr Gnd	3-phase 3-wire corner grounded delta
3PH3W Wye Ungnd	3-phase 3-wire ungrounded wye
3PH3W Wye Gnd	3-phase 3-wire grounded wye
3PH3W Wye Res Gnd	3-phase 3-wire resistance-grounded wye
3PH4W Opn Dlt Ctr Tp	3-phase 4-wire center-tapped open delta
3PH4W Dlt Ctr Tp	3-phase 4-wire center-tapped delta
3PH4W Wye Ungnd	3-phase 4-wire ungrounded wye
3PH4W Wye Gnd	3-phase 4-wire grounded wye
3PH4W Wye Res Gnd	3-phase 4-wire resistance-grounded wye
VT Connect	
Select how many voltage transformers (VT) are connected to the electrical power system.	
Direct Con	Direct connect; no VTs used
2VT	2 voltage transformers
3VT	3 voltage transformers
VT Primary (V)	
1 to 1,000,000	Enter the size of the VT primary, in Volts.
VT Secondary (V)	
100, 110, 115, 120	Select the size of the VT secondary, in Volts.
CT on Terminal	
Define how many current transformers (CT) are connected to the meter, and which terminals they are connected to.	
I1	1 CT connected to I1 terminal
I2	1 CT connected to I2 terminal
I3	1 CT connected to I3 terminal
I1 I2	2 CT connected to I1, I2 terminals
I1 I3	2 CT connected to I1, I3 terminals
I2 I3	2 CT connected to I2, I3 terminals
I1 I2 I3	3 CT connected to I1, I2, I3 terminals
CT Primary (A)	
1 to 32767	Enter the size of the CT primary, in Amps.
CT Secondary (A)	
1, 5	Select the size of the CT secondary, in Amps.
Sys Frequency (Hz)	
50, 60	Select the frequency of the electrical power system, in Hz.
Phase Rotation	
ABC, CBA	Select the phase rotation of the 3-phase system.

Configuring advanced setup parameters using the display

You can configure a subset of advanced parameters using the display.

1. Navigate to **Maint > Setup**.
2. Enter the setup password (default is "0"), then press **OK**.
3. Navigate to **Meter > Advan**.
4. Move the cursor to point to the parameter you want to modify, then press **Edit**.
5. Modify the parameter as required, then press **OK**.
6. Move the cursor to point to the next parameter you want to modify, press **Edit**, make your changes, then press **OK**.
7. Press **Yes** to save your changes.

Advanced setup parameters available using the display

Parameter	Values	Description
Label	—	This label identifies the device, e.g., "Power Meter". You cannot use the display to edit this parameter. Use ION Setup to change the device label.
Load Timer Setpt (A)	0 - 99999	Specifies the minimum average current at the load before the timer starts. The meter begins counting the operating time whenever the readings are equal to or above this average current threshold.
Pk I dmd for TDD (A)	0 - 99999	Specifies the minimum peak current demand at the load for inclusion in total demand distortion (TDD) calculations. If the load current is below the minimum peak current demand threshold, the meter does not use the readings to calculate TDD. Set this to "0" (zero) if you want the power meter to use the metered peak current demand for this calculation.

Setting up regional settings

You can change the regional settings to localize the meter screens and display data in a different language, using local standards and conventions.

NOTE: In order to display a different language other than those listed in the Language setup parameter, you need to download the appropriate language file to the meter using the firmware upgrade process.

1. Navigate to **Maint > Setup**.
2. Enter the setup password (default is "0"), then press **OK**.
3. Navigate to **HMI > Region**.
4. Move the cursor to point to the parameter you want to modify, then press **Edit**.
5. Modify the parameter as required, then press **OK**.
6. Move the cursor to point to the next parameter you want to modify, press **Edit**, make your changes, then press **OK**.
7. Press the up arrow to exit.

8. Press **Yes** to save your changes.

Regional settings available using the display

Parameter	Values	Description
Language	English US, French, Spanish, German, Italian, Portuguese, Chinese, Russian	Select the language you want the meter to display.
Date Format	MM/DD/YY, YY/ MM/DD, DD/ MM/YY	Set how you want the date to be displayed, e.g., month/day/year.
Time Format	24Hr, AM/PM	Set how you want the time to be displayed, e.g., 17:00:00 or 5:00:00 PM.
HMI Mode	IEC, IEEE	Select the standards convention used to display menu names or meter data.

Setting up the screen passwords

It is recommended that you change the default password in order to prevent unauthorized personnel from accessing password-protected screens such as the diagnostics and reset screens.

This can only be configured through the front panel. The factory-default setting for all passwords is "0" (zero).

If you lose your password, you must return the meter for factory reconfiguration, which resets your device to its factory defaults and destroys all logged data.

NOTICE

IRRECOVERABLE PASSWORD

Record your device's user and password information in a secure location.

Failure to follow these instructions can result in data loss.

1. Navigate to **Maint > Setup**.
2. Enter the setup password (default is "0"), then press **OK**.
3. Navigate to **HMI > Pass**.
4. Move the cursor to point to the parameter you want to modify, then press **Edit**.
5. Modify the parameter as required, then press **OK**.
6. Move the cursor to point to the next parameter you want to modify, press **Edit**, make your changes, then press **OK**.
7. Press the up arrow to exit.

8. Press **Yes** to save your changes.

Parameter	Values	Description
Setup	0000 - 9999	Sets the password for accessing the meter setup screens (Maint > Setup).
Energy Resets	0000 - 9999	Sets the password for resetting the meter's accumulated energy values.
Demand Resets	0000 - 9999	Sets the password for resetting the meter's recorded peak demand values.
Min/Max Resets	0000 - 9999	Sets the password for resetting the meter's recorded minimum and maximum values.
Diagnostics	0000 - 9999	Sets the password for accessing the meter's diagnostics screens.

Lost user access

If you lose your meter's user access (password) information, contact your local Schneider Electric representative for instructions on how to return your meter for factory reconfiguration.

NOTE: Have your meter's serial number available for reference.

Setting the clock using the display

The Clock setup screens allow you to set the meter's date and time.

NOTE: You must always set or sync the meter time to UTC (GMT, Greenwich Mean Time), not local time. Use the **GMT Offset (h)** setup parameter to display the correct local time on the meter.

1. Navigate to **Maint > Setup**.
2. Enter the setup password (default is "0"), then press **OK**.
3. Navigate to **Clock**.
4. Move the cursor to point to the parameter you want to modify, then press **Edit**.
5. Modify the parameter as required, then press **OK**.
6. Move the cursor to point to the next parameter you want to modify, press **Edit**, make your changes, then press **OK**.
7. Press the up arrow to exit.

8. Press **Yes** to save your changes.

Parameter	Values	Description
Date	DD/MM/YY MM/DD/YY YY/MM/DD	Set the current date using the format displayed on screen, where DD = day, MM = month and YY = year.
Time	HH:MM:SS (24 hour format) HH:MM:SS AM or PM	Use the 24-hour format to set the current time in UTC (GMT).
Meter Time	GMT, Local	Select GMT if you set the current time to Greenwich Mean Time zone. Otherwise, select Local.
GMT Offset (h) ³	± HH.0	Available only when Meter Time is set to Local. Set the GMT Offset between ± 00.0 and ± 12.0

To configure the clock using ION Setup, see the section for your meter in the ION Setup online help or in the ION Setup device configuration guide, available for download at www.se.com.

³ Currently supports whole integers only.

Communication

Serial communications

The meter supports serial communication through the RS-485 port.

In an RS-485 network, there is one master device, typically an Ethernet to RS-485 gateway. It provides the means for RS-485 communications with multiple slave devices (for example, meters). For applications that require only one dedicated computer to communicate with the slave devices, a USB to RS-485 converter can be used to connect to the master device.

Up to 32 devices can be connected on a single RS-485 bus.

RS-485 network configuration

After you have wired the RS-485 port and powered up the meter, you must configure the serial communications port in order to communicate with the meter.

Each device on the same RS-485 communications bus must have a unique address and all connected devices must be set to the same protocol, baud rate, and parity (data format).

NOTE: To communicate with the meter using ION Setup, you must set the serial site and all connected devices in the RS-485 network to the same parity setting.

For meters that do not have a display, you must first wire and configure each one separately before connecting these meters to the same RS-485 bus.

RS-485 port setup

The meter is factory-configured with default serial communications settings that you may need to modify before connecting the meter to the RS-485 bus.

The meter is factory-configured with the following default serial communications settings:

- Protocol = Modbus RTU
- Address = 1
- Baud rate = 19200
- Parity = Even

You can use a communications converter (USB to RS-485 or RS-232 to RS-485) or Ethernet gateway device to connect to the meter.

Setting up serial communications using the display

The Serial Port setup screen allows you to configure the meter's RS-485 communications port so you can use software to access the meter's data or configure the meter remotely.

1. Navigate to **Maint > Setup**.
2. Enter the setup password (default is "0"), then press **OK**.
3. Press **Comm**.
4. Move the cursor to point to the parameter you want to modify, then press **Edit**.
5. Modify the parameter as required, then press **OK**.
6. Move the cursor to point to the next parameter you want to modify, press **Edit**, make your changes, then press **OK**.

7. Press the up arrow to exit. Press **Yes** to save your changes.

Parameter	Values	Description
Protocol	Modbus	Select the communications format used to transmit data. The protocol must be the same for all devices in a communications loop.
Address	1 to 247	Set the address for this device. The address must be unique for each device in a communications loop. For Jbus protocol, set the device ID to 255.
Baud Rate	9600, 19200, 38400	Select the speed for data transmission. The baud rate must be the same for all devices in a communications loop.
Parity	Even, Odd, None	Select None if the parity bit is not used. The parity setting must be the same for all devices in a communications loop.

Digital output

Digital output applications

The meter is equipped with a digital output port (D1).

After you wire the digital output as per the connection diagram below, you can configure the digital output for energy pulsing applications.

The digital output can be used in energy pulsing applications, where a receiving device determines energy usage by counting the k_h pulses (k_h = kWh, kVARh or kVAh depending on the energy parameter selected) coming from the meter's digital output port.

The digital output can handle voltages less than 40 V DC.

DANGER

HAZARD OF ELECTRIC SHOCK, EXPLOSION, OR ARC FLASH

- Apply appropriate Personal Protective Equipment (PPE) and follow safe electrical work practices. See NFPA 70E, CSA Z462 or other local standards.
- Turn off all power supplying this device and the equipment in which it is installed before working on or in the equipment.
- Always use a properly rated voltage sensing device to confirm that all power is off.
- Assume communications and I/O wiring are hazardous live until determined otherwise.
- Do not exceed the maximum ratings of this device.
- Do not use this device for critical control or protection of persons, animals, property or equipment.
- Do not use the data from the meter to confirm power is off.
- Replace all devices, doors and covers before turning on power to this equipment.

Failure to follow these instructions will result in death or serious injury.

WARNING

UNEXPECTED CHANGE OF STATE OF THE DIGITAL OUTPUT

- Verify the state of the digital output when the power supply to the meter is interrupted or after a meter firmware upgrade.

Failure to follow these instructions can result in death, serious injury, or equipment damage.

Digital output connections

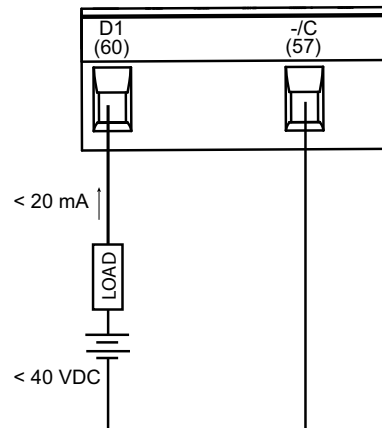

Configuring digital output using the display

You can use the display to configure the digital output.

NOTE: It is recommended you use ION Setup to configure the digital output, as setup parameters that require text entry can only be modified using software.

1. Navigate to **Maint > Setup**.
2. Enter the setup password (default is "0"), then press **OK**.
3. Navigate to **I/O > D Out**.
4. Press **Edit**.
5. Press **+** and **-** to scroll through the modes **None** or **Energy**.

NOTE: If **Edit** is not displayed, it means the parameter is either read-only or can only be modified through software.

6. Press **OK**.
7. Press the up arrow to exit. Press **Yes** to save your changes.

Energy pulsing

You can configure the meter's alarm /energy LED or the digital output(s) for energy pulsing.

- The meter is equipped with an alarm / energy pulsing LED. When configured for energy pulsing, the LED emits pulses that are then used to determine the accuracy of the meter's energy measurements.
- The meter sends the pulses from the configured digital output(s) port, which are then used to determine the accuracy of the meter's energy measurements by pulse counter.

Configuring the alarm / energy pulsing LED using the display

You can use the display to configure your meter's LED for alarming or energy pulsing applications.

1. Navigate to **Maint > Setup**.
2. Enter the setup password (default is "0"), then press **OK**.
3. Navigate to **I/O > LED**.

4. Move the cursor to point to the parameter you want to modify, then press **Edit**.
5. Press the plus or minus buttons to modify the parameter as required, then press **OK**.
6. Press the up arrow to exit. Press **Yes** to save your changes.

Setting	Option or range	Description
Mode	Off, Alarm, Energy	Off turns off the LED completely. Alarm sets the LED for alarm notification. Energy sets the LED for energy pulsing.
Parameter	Active Del Active Rec Active Del + Rec Reactive Del Reactive Rec Reactive Del + Rec Apparent Del Apparent Rec Apparent Del + Rec	Select which accumulated energy channel to monitor and use for energy pulsing. This setting is ignored when the LED mode is set to Alarm.
Pulse Wt. (p/k_h)	1 to 9999999	When configured for energy pulsing, this setting defines how many pulses are sent to the LED for every 1 kWh, 1 kVARh or 1kVAh accumulated energy. This setting is ignored when the LED mode is set to Alarm.

Configuring the alarm / energy pulsing LED or digital output for energy pulsing using ION Setup

You can use ION Setup to configure your meter's LED or digital output for energy pulsing.

1. Start ION Setup.
2. Connect to your meter.
3. Open the **Energy Pulsing** screen.
4. Select the LED or a digital output to configure and click **Edit**.
The setup screen is displayed.
5. Enter a descriptive name for the digital output's **Label**.
6. Configure the other setup parameters as required.

7. Click **Send** to save your changes.

Alarm / energy pulsing LED setup parameters available through ION Setup

Parameter	Values	Description
Mode	LED: Disabled, Alarm, Energy Digital output: External, Energy	LED: <ul style="list-style-type: none"> LED is disabled. Alarm sets the LED for alarm notification. Energy sets the LED for energy pulsing. Digital output: <ul style="list-style-type: none"> Energy: associates the digital output with energy pulsing. External: disassociates the digital output from energy pulsing.
Pulse rate (p/k_h)	1 to 9999999	When configured for energy pulsing, this defines how many pulses are sent to the LED for every 1 kWh, 1 kVARh or 1 kVAh of accumulated energy.
Parameter	Active Energy Delivered Active Energy Received Active Energy Del+Rec Reactive Energy Delivered Reactive Energy Received Reactive Energy Del+Rec Apparent Energy Delivered Apparent Energy Received Apparent Energy Del+Rec	Select which accumulated energy channel to monitor and use for energy pulsing.

Alarms

Alarms overview

An alarm is the meter's means of notifying you when an alarm condition is detected, such as an error or an event that falls outside of normal operating conditions. Alarms are typically setpoint-driven and can be programmed to monitor certain behaviors, events or unwanted conditions in your electrical system.

You can configure your meter to generate and display high, medium and low priority alarms when predefined events are detected in the meter's measured values or operating states. Your meter also logs the alarm event information.

The meter ships with some alarms already enabled from the factory. Other alarms need to be configured before the meter can generate alarms.

Customize meter alarms as required, such as changing the priority. You can also create custom alarms using the advanced features of your meter.

Available alarms

Your meters supports a number of different alarm types.

Type	Number
Unary	4
Standard	29

Unary alarms

A unary alarm is the simplest type of alarm — it monitors a single behavior, event or condition.

Available unary alarms

Your meter has a set of 4 unary alarms.

Alarm label	Description
Meter Powerup	Meter powers on after losing control power.
Meter Reset	Meter resets for any reason.
Meter Diagnostic	Meter's self-diagnostic feature detects a problem.
Phase Reversal	Meter detects a phase rotation different than expected.

Standard alarms

Standard alarms are setpoint-driven alarms which monitor certain behaviors, events or unwanted conditions in your electrical system.

Standard alarms have a detection rate equal to the 50/60 meter cycle, which is nominally 1 second if the meter's frequency setting is configured to match the system frequency (50 or 60 Hz).

Many of the standard alarms are three-phase alarms. Alarm setpoints are evaluated for each of the three phases individually, but the alarm is reported as a single alarm. The alarm pickup occurs when the first phase exceeds the alarm

pickup magnitude for the pickup time delay. The alarm is active as long as any phase remains in an alarm state. The alarm dropout occurs when the last phase drops below the dropout magnitude for the dropout time delay.

Example of over and under setpoint (standard) alarm operation

The meter supports over and under setpoint conditions on standard alarms.

A setpoint condition occurs when the magnitude of the signal being monitored crosses the limit specified by the pickup setpoint setting and stays within that limit for a minimum time period specified by the pickup time delay setting.

The setpoint condition ends when the magnitude of the signal being monitored crosses the limit specified by dropout setpoint setting and stays within that limit for a minimum time period specified by dropout time delay setting.

Over setpoint

When the value rises above the pickup setpoint setting and remains there long enough to satisfy the pickup time delay period ($\Delta T1$), the alarm condition is set to ON. When the value falls below the dropout setpoint setting and remains there long enough to satisfy the dropout time delay period ($\Delta T2$), the alarm condition is set to OFF.

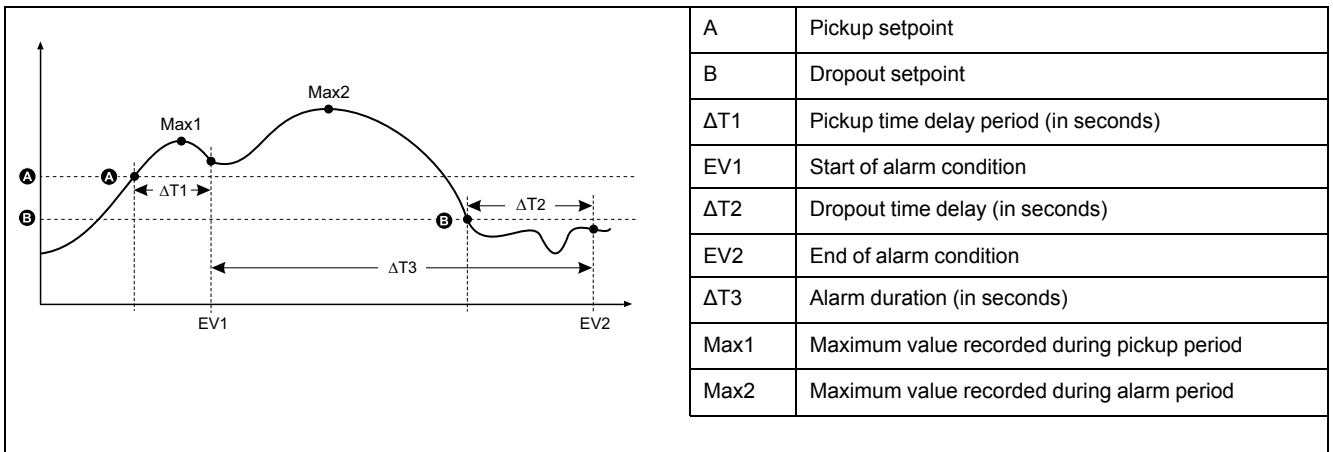

The meter records the date and time when the alarm event starts (EV1) and when it ends (EV2). The meter also performs any task assigned to the event, such as flashing LED. The meter also records maximum values (Max1, Max2) before, during or after the alarm period.

Under setpoint

When the value falls below the pickup setpoint setting and remains there long enough to satisfy the pickup time delay period ($\Delta T1$), the alarm condition is set to ON. When the value rises above the dropout setpoint setting and remains there long enough to satisfy the dropout time delay period ($\Delta T2$), the alarm condition is set to OFF.

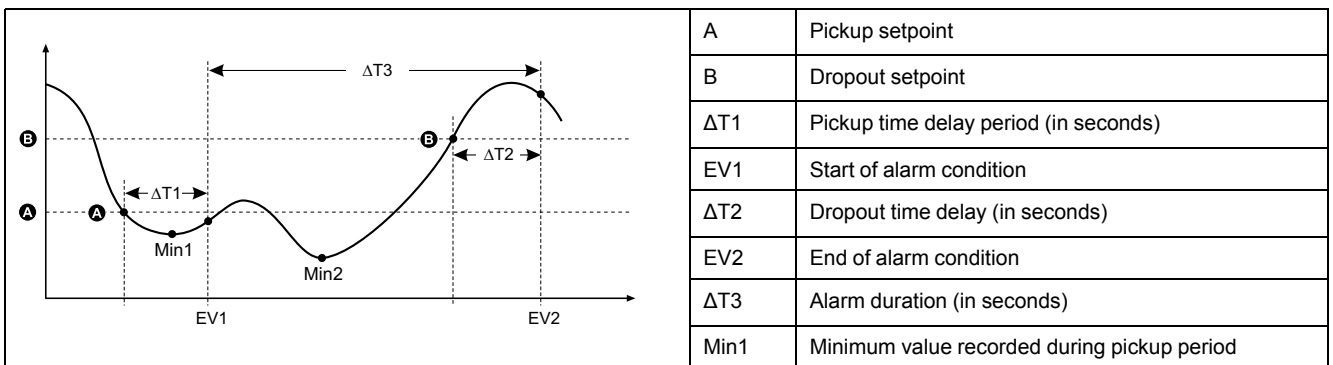

	Min2	Minimum value recorded during alarm period
--	------	--

The meter records the date and time when the alarm event starts (EV1) and when it ends (EV2). The meter also performs any task assigned to the event, such as flashing LED. The meter also records minimum values (Min1, Min2) before, during or after the alarm period.

Maximum allowable setpoint

The meter is programmed to help prevent user data entry errors, with set limits for the standard alarms.

The maximum setpoint value you can enter for some of the standard alarms depends on the voltage transformer ratio (VT ratio), current transformer ratio (CT ratio), system type (i.e., number of phases) and/or the maximum voltage and maximum current limits programmed at the factory.

NOTE: VT ratio is the VT primary divided by the VT secondary and CT ratio is the CT primary divided by the CT secondary.

Standard alarm	Maximum setpoint value
Over Phase Current	(maximum current) x (CT ratio)
Under Phase Current	(maximum current) x (CT ratio)
Over Neutral Current	(maximum current) x (CT ratio) x (number of phases)
Over Ground Current	(maximum current) x (CT ratio)
Over Voltage L-L	(maximum voltage) x (VT ratio)
Under Voltage L-L	(maximum voltage) x (VT ratio)
Over Voltage L-N	(maximum voltage) x (VT ratio)
Under Voltage L-N	(maximum voltage) x (VT ratio)
Over Active Power	(maximum voltage) x (maximum current) x (number of phases)
Over Reactive Power	(maximum voltage) x (maximum current) x (number of phases)
Over Apparent Power	(maximum voltage) x (maximum current) x (number of phases)
Over Present Active Power Demand	(maximum voltage) x (maximum current) x (number of phases)
Over Last Active Power Demand	(maximum voltage) x (maximum current) x (number of phases)
Over Predicted Active Power Demand	(maximum voltage) x (maximum current) x (number of phases)
Over Present Reactive Power Demand	(maximum voltage) x (maximum current) x (number of phases)
Over Last Reactive Power Demand	(maximum voltage) x (maximum current) x (number of phases)
Over Predicted Reactive Power Demand	(maximum voltage) x (maximum current) x (number of phases)
Over Present Apparent Power Demand	(maximum voltage) x (maximum current) x (number of phases)
Over Last Apparent Power Demand	(maximum voltage) x (maximum current) x (number of phases)
Over Predicted Apparent Power Demand	(maximum voltage) x (maximum current) x (number of phases)
Over Voltage Unbalance	(maximum voltage) x (VT ratio)
Phase Loss	(maximum voltage) x (VT ratio)

Available standard alarms

Your meter has a set of standard alarms.

NOTE: Some alarms do not apply to all power system configurations. For example, line-to-neutral voltage alarms cannot be enabled on 3-phase delta systems. Some alarms use the system type and the VT or CT ratio to determine the maximum allowed setpoint.

Alarm label		Valid range and resolution		Units
ION Setup	Display	ION Setup	Display	
Over Phase Current	Over Current, Ph	0.000 to 99999.000	0 to 99999	A
Under Phase Current	Under Current, Ph	0.000 to 99999.000	0 to 99999	A
Over Neutral Current	Over Current, N	0.000 to 99999.000	0 to 99999	A
Over Ground Current	Over Current, Gnd	0.000 to 99999.000	0 to 99999	A
Over Voltage L-L	Over Voltage, L-L	0.00 to 999999.00	0 to 999999	V
Under Voltage L-L	Under Voltage, L-L	0.00 to 999999.00	0 to 999999	V
Over Voltage L-N	Over Voltage, L-N	0.00 to 999999.00	0 to 999999	V
Under Voltage L-N	Under Voltage L-N	0.00 to 999999.00	0 to 999999	V
Over Active Power	Over kW	0.0 to 9999999.0	0 to 9999999	kW
Over Reactive Power	Over kVAR	0.0 to 9999999.0	0 to 9999999	kVAR
Over Apparent Power	Over kVA	0.0 to 9999999.0	0 to 9999999	kVA
Leading True PF	Lead PF, True	-1.00 to -0.01 and 0.01 to 1.00		—
Lagging True PF	Lag PF, True	-1.00 to -0.01 and 0.01 to 1.00		—
Leading Disp PF	Lead PF, Disp	-1.00 to -0.01 and 0.01 to 1.00		—
Lagging Disp PF	Lag PF, Disp	-1.00 to -0.01 and 0.01 to 1.00		—
Over Present Active Power Demand	Over kW Dmd, Pres	0.0 to 9999999.0	0 to 9999999	kW
Over Last Active Power Demand	Over kW Dmd, Last	0.0 to 9999999.0	0 to 9999999	kW
Over Predicted Active Power Demand	Over kW Dmd, Pred	0.0 to 9999999.0	0 to 9999999	kW
Over Present Reactive Power Demand	Over kVAR Dmd, Pres	0.0 to 9999999.0	0 to 9999999	kVAR
Over Last Reactive Power Demand	Over kVAR Dmd, Last	0.0 to 9999999.0	0 to 9999999	kVAR
Over Predicted Reactive Power Demand	Over kVAR Dmd, Pred	0.0 to 9999999.0	0 to 9999999	kVAR
Over Present Apparent Power Demand	Over kVA Dmd, Pres	0.0 to 9999999.0	0 to 9999999	kVA
Over Last Apparent Power Demand	Over kVA Dmd, Last	0.0 to 9999999.0	0 to 9999999	kVA
Over Predicted Apparent Power Demand	Over kVA Dmd, Pred	0.0 to 9999999.0	0 to 9999999	kVA
Over Frequency	Over Frequency	0.000 to 99.000		Hz
Under Frequency	Under Frequency	0.000 to 99.000		Hz
Over Voltage Unbalance	Over Voltage Unbal	0 to 99		%
Over Voltage THD	Over Voltage THD	0 to 99		%
Phase Loss	Phase Loss	0.00 to 999999.00	0 to 999999	—

Power factor (PF) alarms

You can set up a Leading PF or Lagging PF alarm to monitor when the circuit's power factor goes above or below the threshold you specify.

The Leading PF and Lagging PF alarms use the power factor quadrants as the values on the y-axis, with quadrant II on the lowest end of the scale, followed by quadrant III, quadrant I, and finally quadrant IV on the highest end of the scale.

Quadrant	PF values	Lead/Lag
II	0 to -1	Leading (capacitive)
III	-1 to 0	Lagging (inductive)
I	0 to 1	Lagging (inductive)
IV	1 to 0	Leading (capacitive)

Leading PF alarm

The Leading PF alarm monitors an over setpoint condition.

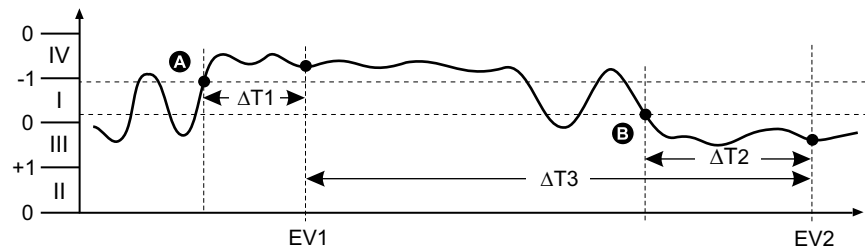

A	Pickup setpoint	$\Delta T2$	Dropout time delay (in seconds)
B	Dropout setpoint	EV2	End of alarm condition
$\Delta T1$	Pickup delay period (in seconds)	$\Delta T3$	Alarm duration (in seconds)
EV1	Start of alarm condition		

Lagging PF alarm

The Lagging PF alarm monitors an under setpoint condition.

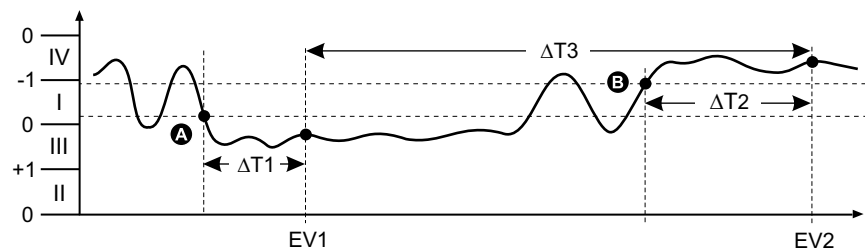

A	Pickup setpoint	$\Delta T2$	Dropout time delay (in seconds)
B	Dropout setpoint	EV2	End of alarm condition
$\Delta T1$	Pickup delay period (in seconds)	$\Delta T3$	Alarm duration (in seconds)
EV1	Start of alarm condition		

Phase loss alarm

The phase loss alarm is an under setpoint alarm that monitors the voltages on a 3-phase system and triggers the alarm when one or two phases fall below the pickup setpoint setting and remain there long enough to satisfy the pickup time delay period.

When all of the phases rise above the dropout setpoint setting and remain there long enough to satisfy the dropout time delay period, the alarm condition is set to OFF.

Alarm priorities

Each alarm has a priority level that you can use to distinguish between events that require immediate action and those that do not require action.

Alarm priority	Alarm display notification and recording method			
	Alarm LED	Alarm icon	Alarm details	Alarm logging
High	Blinks while the alarm is active.	Blinks while the alarm is active. Alarm icon remains displayed until acknowledged.	Click Details to display what caused the alarm to pickup or drop off. Click Ack to acknowledge the alarm.	Recorded in alarm log.
Medium	Blinks while the alarm is active.	Blinks while the alarm is active.	Click Details to display what caused the alarm to pickup or drop off.	Recorded in alarm log.
Low	Blinks while the alarm is active.	Blinks while the alarm is active.	Click Details to display what caused the alarm to pickup or drop off.	Recorded in alarm log.
None	No activity	None	None	Recorded in event log only.

NOTE: The alarm LED notification only occurs if the alarm / energy pulsing LED is configured for alarming.

Multiple alarm considerations

If multiple alarms with different priorities are active at the same time, the display shows the alarms in the order they occurred.

Alarm setup overview

You can use the meter display or ION Setup to configure unary or standard (1-Sec) alarms.

If you make changes to the basic power meter setup, all alarms are disabled to prevent undesired alarm operation. If you configure standard alarm setpoints using the display, any decimals previously configured using ION Setup are lost.

NOTICE

UNINTENDED EQUIPMENT OPERATION

- Verify all alarm settings are correct and make adjustments as necessary.
- Re-enable all configured alarms.

Failure to follow these instructions can result in incorrect alarm functions.

Built-in error-checking

ION Setup dynamically checks incorrect setup combinations. When you enable an alarm, you must set up the pickup and dropout limits to acceptable values first in order to exit the setup screen.

Setting up alarms using the display

You can use the display to create and set up standard (1-Sec) and unary alarms.

It is recommended that you use ION Setup to configure standard (1-Sec) alarms. ION Setup supports a higher resolution to allow you to specify more decimal places when setting up the pickup setpoint and dropout setpoint values for certain measurements.

1. Navigate to the alarms setup menu screens and select the alarm you want to set up.

2. Configure the setup parameters as explained in the different alarm setup sections.

NOTE: If you used ION Setup to program decimal values on a standard (1-Sec) alarm, do not use the meter display to make subsequent changes to any alarm parameters (including enable/disable), as doing so will cause removal of all decimals previously programmed through ION Setup.

3. Click **Yes** to save the changes to the meter when prompted.

Setting up alarms using ION Setup

You can use ION Setup to create and set up alarms.

1. Start ION Setup and connect to your meter.
2. Open the **Alarming** screen.
3. Select the alarm you want to configure and click **Edit**.
4. Configure the setup parameters as explained in the different alarm setup sections.

See the ION Setup Device Configuration guide for more information.

Unary alarm setup parameters

Configure the unary alarm setup parameters as required.

ION Setup controls are shown in parentheses.

Setting	Option or range	Description
Enable	Yes (checked) or No (cleared)	This enables or disables the alarm.
Priority	High, Medium, Low, None	This sets the alarm priority and notification options.
Select Dig Output	None Digital Output D1	Select the output(s) you want to control when the alarm is triggered.

Standard (1-Sec) alarm setup parameters

Configure the standard alarm setup parameters as required.

ION Setup controls are shown in parentheses.

NOTE: It is recommended that you use ION Setup to configure standard (1-Sec) alarms. ION Setup supports a higher resolution to allow you to specify more decimal places when setting up the pickup setpoint and dropout setpoint values for certain measurements.

Setting	Option or range	Description
Enable	Yes (checked) or No (cleared)	This enables or disables the alarm.
Priority	High, Medium, Low, None	This sets the alarm priority and notification options.
Pickup Setpoint (Pickup Limit)	Varies depending on the standard alarm you are setting up	This is the value (magnitude) you define as the setpoint limit for triggering the alarm. For "over" conditions, this means the value has gone above the Pickup limit. For "under" conditions, this means the value has gone below the Pickup limit.
Pickup Time Delay (Delay)	0 to 999999	This specifies the number of seconds the signal must stay above the pickup setpoint (for "over" conditions), or below the pickup setpoint (for "under" conditions) before the alarm is tripped.

Setting	Option or range	Description
Dropout Setpoint (Dropout Limit)	Varies depending on the standard alarm you are setting up	This is the value (magnitude) you define as the limit for dropping out of the alarm condition. For "over" conditions, this means the value has gone below the Dropout limit. For "under" conditions, this means the value has gone above the Pickup limit.
Dropout Time Delay (Delay)	0 to 999999	This specifies the number of seconds the signal must stay below the dropout setpoint (for "over" conditions), or above the dropout setpoint (for "under" conditions) before the alarm condition is ended.
PU Set Point Lead/Lag (Lead, Lag)	Lead or Lag	Applies to PF (power factor) alarms only. Use this to set the PF value and quadrant to set the pickup setpoint for an over PF condition (PF Leading) or under PF condition (PF Lagging).
DO Set Point Lead/Lag (Lead, Lag)	Lead or Lag	Applies to PF (power factor) alarms only. Use this to set the PF value and quadrant to set the dropout setpoint for an over PF condition (PF Leading) or under PF condition (PF Lagging).
Select Dig Output	None Digital Output D1	Select the output(s) you want to control when the alarm is triggered.

LED alarm indicator

You can use the meter's alarm / energy pulsing LED as an alarm indicator.

When set to detect alarms, the LED blinks to indicate an alarm condition.

Configuring the LED for alarms using the display

You can use the meter display to configure the alarm / energy pulsing LED for alarming.

1. Navigate to the **LED** setup menu screen.
2. Set the mode to **Alarm**, then press **OK**.
3. Press the up arrow to exit. Press **Yes** to save your changes.

Configuring the LED for alarms using ION Setup

You can use the ION Setup to configure your meter's LED for alarming.

1. Open ION Setup and connect to your meter. See the ION Setup Help for instructions.
2. Open the **Energy Pulsing** screen.
3. Select **Front Panel LED** and click **Edit**.
4. Set the control mode to **Alarm**.
5. Click **Send** to save your changes.

Alarm display and notification

The meter notifies you when an alarm condition is detected.

Alarm icon

When a low, medium or high priority alarm is tripped, this symbol appears at the top right corner of the display screen, indicating that an alarm is active:



For high priority alarms, the alarm icon remains displayed until you acknowledge the alarm.

Alarm / energy pulsing LED

If configured for alarming, the alarm / energy pulsing LED also flashes to indicate the meter has detected an alarm condition.

Alarm screens

You can use the display buttons to navigate to the alarm setup or display screens.

Active alarms

When a pickup event occurs, the active alarm list appears on the meter display's Active Alarms screen. Press **Detail** to see more event information.

Alarm details

Details about the alarms can be viewed using:

- the active alarms (Active), alarm history (Hist), alarm counters (Count) and unacknowledged alarms (Unack) screens on the meter display, or

Active alarms list and alarm history log

Each occurrence of a low, medium or high priority alarm is stored in the active alarms list and recorded in the alarm history log.

The active alarm list holds 40 entries at a time. The list works as a circular buffer, replacing old entries as new entries over 40 are entered into the active alarms list. The information in the active alarms list is volatile and reinitializes when the meter resets.

The alarm history log holds 40 entries. The log also works as a circular buffer, replacing old entries with new entries. The information in the alarm history log is nonvolatile and is retained when the meter resets.

Viewing active alarm details using the display

When an alarm condition becomes true (alarm = ON), the alarm is displayed on the active alarms screen.

Alarms are displayed sequentially in the order of their occurrence, regardless of priority. The alarm details show the date and time of the alarm event, the type of event (for example, pickup or unarm), which phase the alarm condition was detected on, and the value that caused the alarm condition.

NOTE: Alarm details are not available if the alarm priority is set to None.

The alarm details (for low, medium and high priority alarms) are also recorded in the alarm history log.

1. Navigate to **Alarm > Active**.

2. Select the alarm you want to view (the latest ones appear on top).
3. Press **Detail**.

NOTE: For unacknowledged high priority alarms, the **Ack** option appears on this screen. Press **Ack** to acknowledge the alarm, or return to the previous screen if you do not want to acknowledge the alarm.

Viewing alarm history details using the display

The alarm history log keeps a record of active alarms and past alarms.

When an active alarm condition becomes false (alarm = OFF), the event is recorded in the alarm history log and alarm notification (alarm icon, alarm LED) is turned off.

Alarms are displayed sequentially in the order of their occurrence, regardless of priority. The alarm details show the date and time of the alarm event, the type of event (for example, dropout or unary), which phase the alarm condition was detected on, and the value that caused the alarm condition to turn ON or OFF.

NOTE: Alarm details are not available if the alarm priority is set to None.

1. Navigate to **Alarm > Hist**.
2. Select the alarm you want to view (the latest ones appear on top).
3. Press **Detail**.

NOTE: For unacknowledged high priority alarms, the **Ack** option appears on this screen. Press **Ack** to acknowledge the alarm, or return to the previous screen if you do not want to acknowledge the alarm.

Viewing alarms counters using the display

Every occurrence of each type of alarm is counted and recorded in the meter.

NOTE: The alarm counters roll over to zero after reaching the value 9999.

1. Select **Alarm > Count**.
The **Alarms Counter** screen displays.
2. Scroll through the list to view the number of alarm occurrences for each type of alarm.

Acknowledging high-priority alarms using the display

You can use the meter display to acknowledge high-priority alarms.

1. Navigate to **Alarm > Unack**.
2. Select the alarm you want to acknowledge.
3. Press **Detail**.
4. Press **Ack** to acknowledge the alarm.
5. Repeat for other unacknowledged alarms.

Resetting alarms using ION Setup

Use ION Setup to reset alarms.

You can also reset alarms using the meter display.

1. Connect to your meter in ION Setup.
2. Open the **Meter Resets** screen.
3. Select the alarm parameters to clear and click **Reset**.

Measurements and calculations

Real-time readings

The power and energy meter measures current and voltages and reports in real time the RMS (Root Mean Squared) values for all three phases and neutral.

The voltage and current inputs are continuously monitored at a sampling rate of 64 points per cycle. This amount of resolution helps enable the meter to provide reliable measurements and calculated electrical values for various commercial, buildings and industrial applications.

Energy

The meter provides fully bi-directional, 4-quadrant energy metering.

The meter calculates and stores all accumulated active, reactive and apparent energy measurements in nonvolatile memory:

- Wh, VARh, VAh (delivered and received)
- Wh, VARh, VAh net (delivered - received)
- Wh, VARh, VAh absolute (delivered + received)

All energy parameters represent the total for all three phases. You can view accumulated energy from the display.

Configuring the energy scaling using ION Setup

You can use ION Setup to configure the energy scaling. Based on the scaling, the energy overflow happens upon reaching the threshold value.

1. Start ION Setup.
2. Connect to your meter.
3. Open the **Energy Scaling** screen.
4. Click **Edit** to configure the **Setup** parameters as required.
5. Use the drop-down list to select the parameter you want to set for your **Energy Scaling**.

NOTE: If you set **Energy Scaling** parameter, for which the threshold value is less than the accumulated energy, the accumulated energy resets to zero.

6. Click **Send** to save your changes to the meter.

Energy Scaling parameters available using the ION Setup

Parameter	Values	Description
Auto (Default)	0 to 9.2233 E	The energy value units automatically change, based on the quantity of energy accumulated, from Kilo to Mega, Mega to Giga, Giga to Tera, Tera to Peta and Peta to Exa. When any one of the energy parameter (delivered or received) exceeds 9.2233 E, all the energy parameters reset to 0.
Kilo (k)	0 to 999.99 k	When any one of the energy parameter (delivered or received) exceeds 999.99 k, all the energy parameters reset to 0.
Mega (M)	0 to 999.99 M	The energy value units automatically change, based on the quantity of energy accumulated, from Kilo to Mega. When any one of the energy parameter (delivered or received) exceeds 999.99 M, all the energy parameters reset to 0.
Giga (G)	0 to 999.99 G	The energy value units automatically change, based on the quantity of energy accumulated, from Kilo to Mega and Mega to Giga. When any one of the energy parameter (delivered or received) exceeds 999.99 G, all the energy parameters reset to 0.
Tera (T)	0 to 999.99 T	The energy value units automatically change, based on the quantity of energy accumulated, from Kilo to Mega, Mega to Giga and Giga to Tera. When any one of the energy parameter (delivered or received) exceeds 999.99 T, all the energy parameters reset to 0.
Peta (P)	0 to 999.99 P	The energy value units automatically change, based on the quantity of energy accumulated, from Kilo to Mega, Mega to Giga, Giga to Tera and Tera to Peta. When any one of the energy parameter (delivered or received) exceeds 999.99 P, all the energy parameters reset to 0.
Exa (E)	0 to 9.2233 E	The energy value units automatically change, based on the quantity of energy accumulated, from Kilo to Mega, Mega to Giga, Giga to Tera, Tera to Peta and Peta to Exa. When any one of the energy parameter (delivered or received) exceeds 9.2233 E, all the energy parameters reset to 0.

Preset energy

NOTE: Not applicable for MID meter models.

You can input the previous energy values when you replace the meter. Preset energy value cannot be set more than maximum energy overflow value (9.2233 E).

The preset energy values include active energy (Wh), reactive energy (VARh), apparent energy (VAh) (delivered and received).

Configuring the preset energy using ION Setup

NOTE: Not applicable for MID meter models.

You can use ION Setup to configure the preset energy values.

1. Start ION Setup.
2. Connect to your meter.
3. Open the **Preset Energy** screen.
4. Click **Edit** to configure the **Setup** parameters as required.
5. From the list, set the **Preset Energy** value for each parameter.

6. Click **Send** to save your changes to the meter.

Preset Energy parameters available using the ION Setup

Parameter	Values	Description
Active Energy Delivered	0 to 9.2233 E	Use this field to enter the preset energy values
Active Energy Received		
Reactive Energy Delivered		
Reactive Energy Received		
Apparent Energy Delivered		
Apparent Energy Received		

Min/max values

When the readings reach their lowest or highest value, the meter updates and saves these min/max (minimum and maximum) quantities in non-volatile memory.

The meter's real-time readings are updated once every 50 cycles for 50 Hz systems, or once every 60 cycles for 60 Hz systems.

Demand

Power demand

Power demand is a measure of average power consumption over a fixed time interval.

NOTE: If not specified, references to demand are assumed to mean power demand.

The meter measures instantaneous consumption and can calculate demand using various methods.

Current demand

The meter calculates current demand using the block interval, synchronized or thermal demand methods.

You can set the demand interval from 1 to 60 minutes in 1 minute increments (for example, 15 minutes).

Power demand calculation methods

Power demand is calculated by dividing the energy accumulated during a specified period by the length of that period.

How the meter performs this calculation depends on the method and time parameters you select (for example, timed rolling block demand with a 15-minute interval and 5-minute subinterval).

To be compatible with electric utility billing practices, the meter provides the following types of power demand calculations:

- Block interval demand
- Synchronized demand
- Thermal demand

You can configure the power demand calculation method from the display or software.

Block interval demand

For block interval demand method types, you specify a period of time interval (or block) that the meter uses for the demand calculation.

Select/configure how the meter handles that interval from one of these different methods:

Type	Description
Timed Sliding Block	Select an interval from 1 to 60 minutes (in 1-minute increments). If the interval is between 1 and 15 minutes, the demand calculation <i>updates every 15 seconds</i> . If the interval is between 16 and 60 minutes, the demand calculation <i>updates every 60 seconds</i> . The meter displays the demand value for the last completed interval.
Timed Block	Select an interval from 1 to 60 minutes (in 1-minute increments). The meter calculates and updates the demand at the end of each interval.
Timed Rolling Block	Select an interval and a subinterval. The subinterval must divide evenly into the interval (for example, three 5-minute subintervals for a 15-minute interval). Demand is <i>updated at the end of each subinterval</i> . The meter displays the demand value for the last completed interval.

Block interval demand example

The following illustration shows the different ways power demand is calculated using the block interval method. In this example, the interval is set to 15 minutes.

Timed Sliding Block

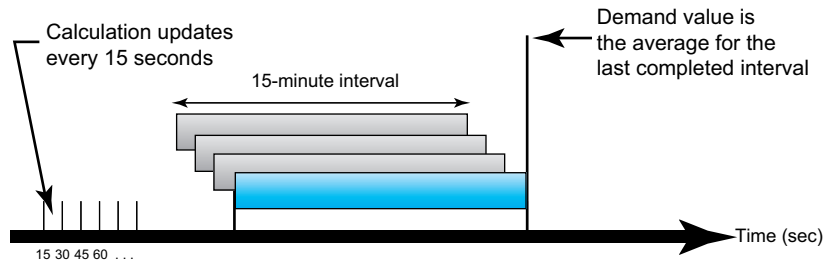

Timed Block

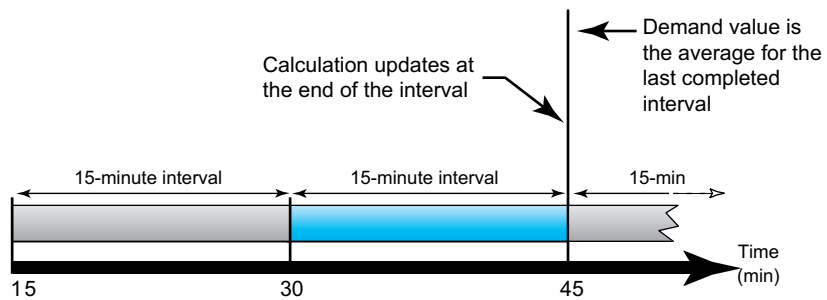

Timed Rolling Block

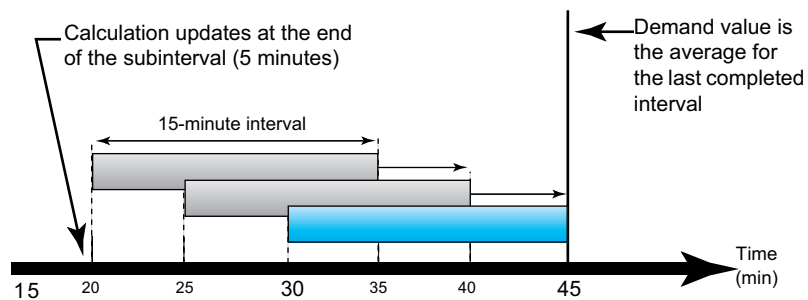

Synchronized demand

You can configure the demand calculations to be synchronized using a command sent over communications, or the device’s internal real-time clock.

Type	Description
Command synchronized demand	This method allows you to synchronize the demand intervals of multiple meters on a communications network. For example, if a programmable logic controller (PLC) input is monitoring a pulse at the end of a demand interval on a utility revenue meter, you can program the PLC to issue a command to multiple meters whenever the utility meter starts a new demand interval. Each time the command is issued, the demand readings of each meter are calculated for the same interval.
Clock synchronized demand	This method allows you to synchronize the demand interval to the meter’s internal real-time clock. This helps you synchronize the demand to a particular time, typically on the hour (for example, at 12:00 am). If you select another time of day when the demand intervals are to be synchronized, the time must be specified in minutes from midnight. For example, to synchronize at 8:00 am, select 480 minutes.

NOTE: For these demand types, you can choose block or rolling block options. If you select a rolling block demand option, you need to specify a subinterval.

Thermal demand

Thermal demand calculates the demand based on a thermal response, which imitates the function of thermal demand meters.

The demand calculation updates at the end of each interval. You can set the demand interval from 1 to 60 minutes (in 1-minute increments).

Thermal demand example

The following illustration shows the thermal demand calculation. In this example, the interval is set to 15 minutes. The interval is a window of time that moves across the timeline. The calculation updates at the end of each interval.

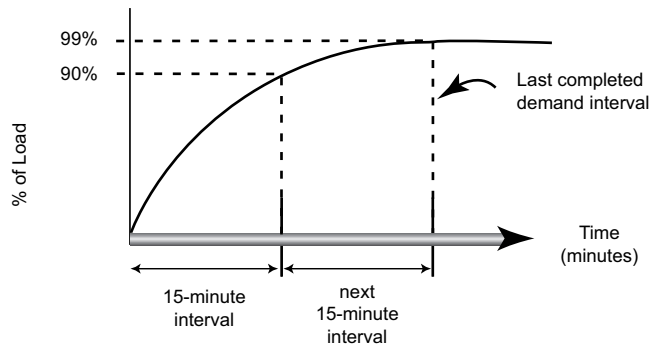

Peak demand

The meter records the peak (or maximum) values for kWd, kVARD, and kVAD power (or peak demand).

The peak for each value is the highest average reading since the meter was last reset. These values are maintained in the meter’s non-volatile memory.

The meter also stores the date and time when the peak demand occurred. In addition to the peak demand, the meter also stores the coinciding average 3-phase power factor. The average 3-phase power factor is defined as “demand kW/ demand kVA” for the peak demand interval.

Predicted demand

The meter calculates predicted demand for the end of the present interval for kW, kVAR, and kVA demand, taking into account the energy consumption so far within the present (partial) interval and the present rate of consumption.

Predicted demand is updated according to the update rate of your meter.

The following illustration shows how a change in load can affect predicted demand for the interval. In this example, the interval is set to 15 minutes.

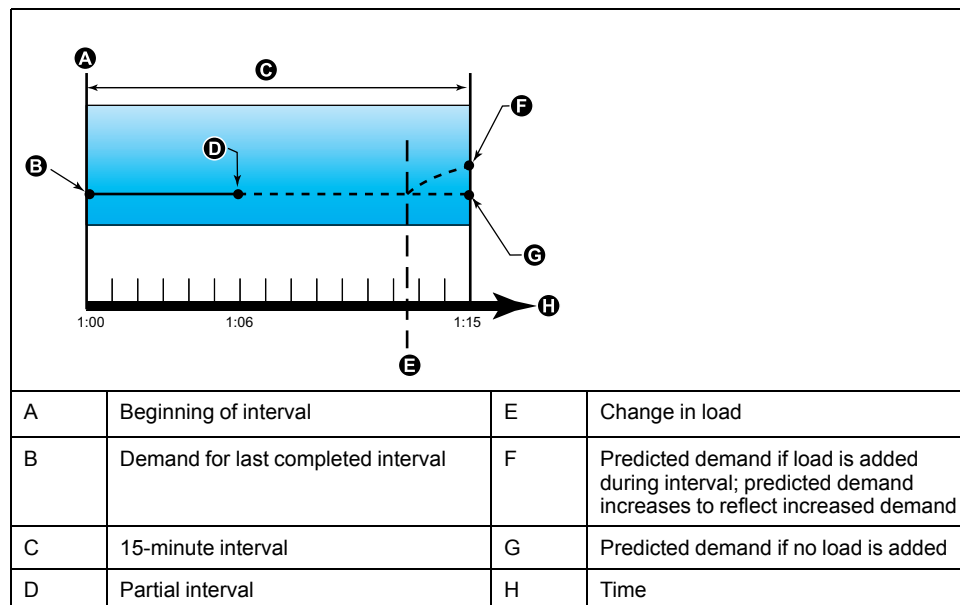

Setting up demand calculations

Use the Demand setup screens to define power or current demand.

Demand is a measure of average consumption over a fixed time interval.

1. Navigate to **Maint > Setup**.
2. Enter the setup password (default is "0"), then press **OK**.
3. Navigate to **Meter > Dmd**.
4. Move the cursor to select **Power Demand** or **Current Demand**.

5. Move the cursor to point to the parameter you want to modify, then press **Edit**.

Values	Description
Method	
Timed Sliding Block Timed Block Timed Rolling Block Cmd Sync Block Cmd Sync Roll Block Clock Sync Block Clock Sync Roll Block Thermal	Select the appropriate demand calculation method for your needs
Interval	
0 - 60	Set the demand interval, in minutes.
Subinterval	
0 - 60	Applies only to rolling block methods. Define how many subintervals the demand interval should be equally divided into.
Clock Sync Time	
0 - 2359	Applies only to clock sync methods (these synchronize the demand interval to the meter's internal clock). Define what time of day you want to synchronize the demand, from the start of the day. For example, set this setting to 0730 to synchronize demand at 7:30 AM.

6. Modify the parameter as required, then press **OK**.
7. Move the cursor to point to the next parameter you want to modify, press **Edit**, make your changes, then press **OK**.
8. Press **Yes** to save your changes.

Power factor (PF)

Power factor (PF) is the ratio of real power (P) to apparent power (S).

PF is provided as a number between -1 and 1 or as a percentage from -100% to 100%, where the sign is determined by the convention.

$$PF = \frac{P}{S}$$

A purely resistive load has no reactive components, so its power factor is 1 (PF = 1, or unity power factor). Inductive or capacitive loads introduce a reactive power (Q) component to the circuit which causes the PF to become closer to zero.

True PF and displacement PF

The meter supports true power factor and displacement power factor values:

- True power factor includes harmonic content.
- Displacement power factor only considers the fundamental frequency.

NOTE: Unless specified, the power factor displayed by the meter is true power factor.

Real, reactive and apparent power (PQS)

A typical AC electrical system load has both resistive and reactive (inductive or capacitive) components.

Real power, also known as active power (P) is consumed by resistive loads. Reactive power (Q) is either consumed by inductive loads or generated by capacitive loads.

Apparent power (S) is the capacity of your measured power system to provide real and reactive power.

The units for power are watts (W or kW) for real power P, vars (VAR or kVAR) for reactive power Q, and volt-amps (VA or kVA) for apparent power S.

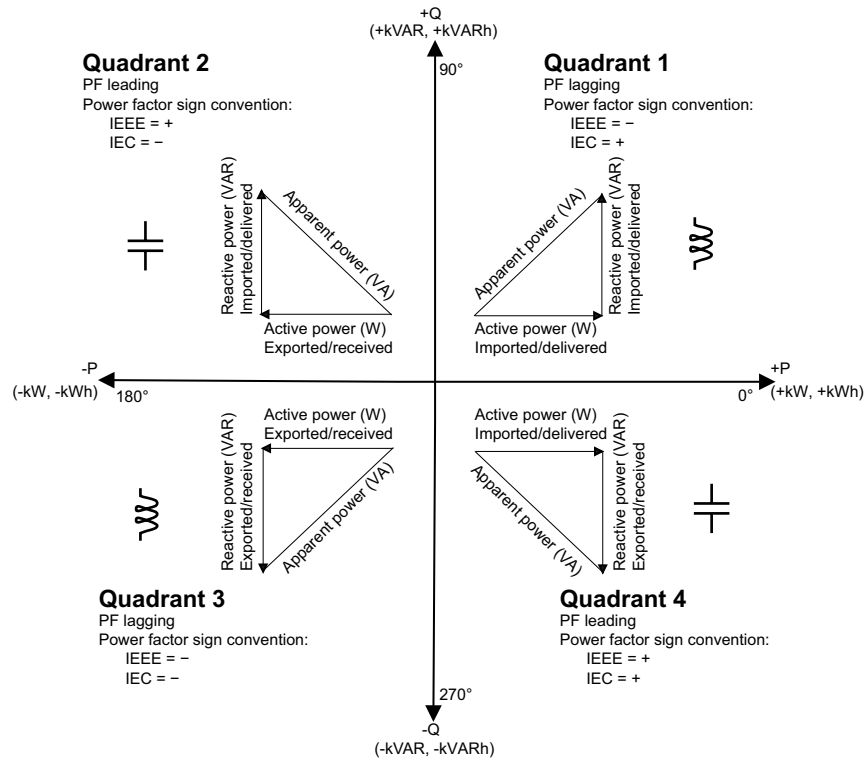

Power flow

Positive real power P(+) flows from the power source to the load. Negative real power P(-) flows from the load to the power source.

Power factor sign convention

Power factor sign (PF sign) can be positive or negative, and is defined by the conventions used by the IEEE or IEC standards.

You can set the power factor sign (PF sign) convention that is used on the display to either IEC or IEEE.

PF sign convention: IEC

PF sign correlates with the direction of real power (kW) flow.

- Quadrant 1 and 4: Positive real power (+kW), the PF sign is positive (+).
- Quadrant 2 and 3: Negative real power (-kW), the PF sign is negative (-).

PF sign convention: IEEE

PF sign is correlated with the PF lead/lag convention, in other words, the effective load type (inductive or capacitive):

- For a capacitive load (PF leading, quadrant 2 and 4), the PF sign is positive (+).
- For an inductive load (PF lagging, quadrant 1 and 3), the PF sign is negative (-).

Power factor register format

The meter provides power factor values in a variety of formats to suit your energy management software.

Power factor in IEC and lead/lag (IEEE) formats: Float32 and Int16U registers

The meter provides total power factor in IEC and lead/lag (IEEE) formats in both Float32 and Int16U data types. You can use these registers to bring power factor information into third-party software. These registers are interpreted using the standard IEC and IEEE sign conventions.

NOTE: For information on how to calculate actual power factor values from the values in Int16U registers, see your meter's Modbus register list, available from www.se.com.

Four quadrant power factor information: floating point registers

The meter also provides PF information (including sign and quadrant) in single floating point registers for each of the PF values (for example, per-phase and total values for true and displacement PF, and associated minimums and maximums). The meter performs a simple algorithm to the PF value then stores it in the appropriate PF register.

The meter and software (such as Power Monitoring Expert or ION Setup) interpret these PF registers for reporting or data entry fields according to the following diagram:

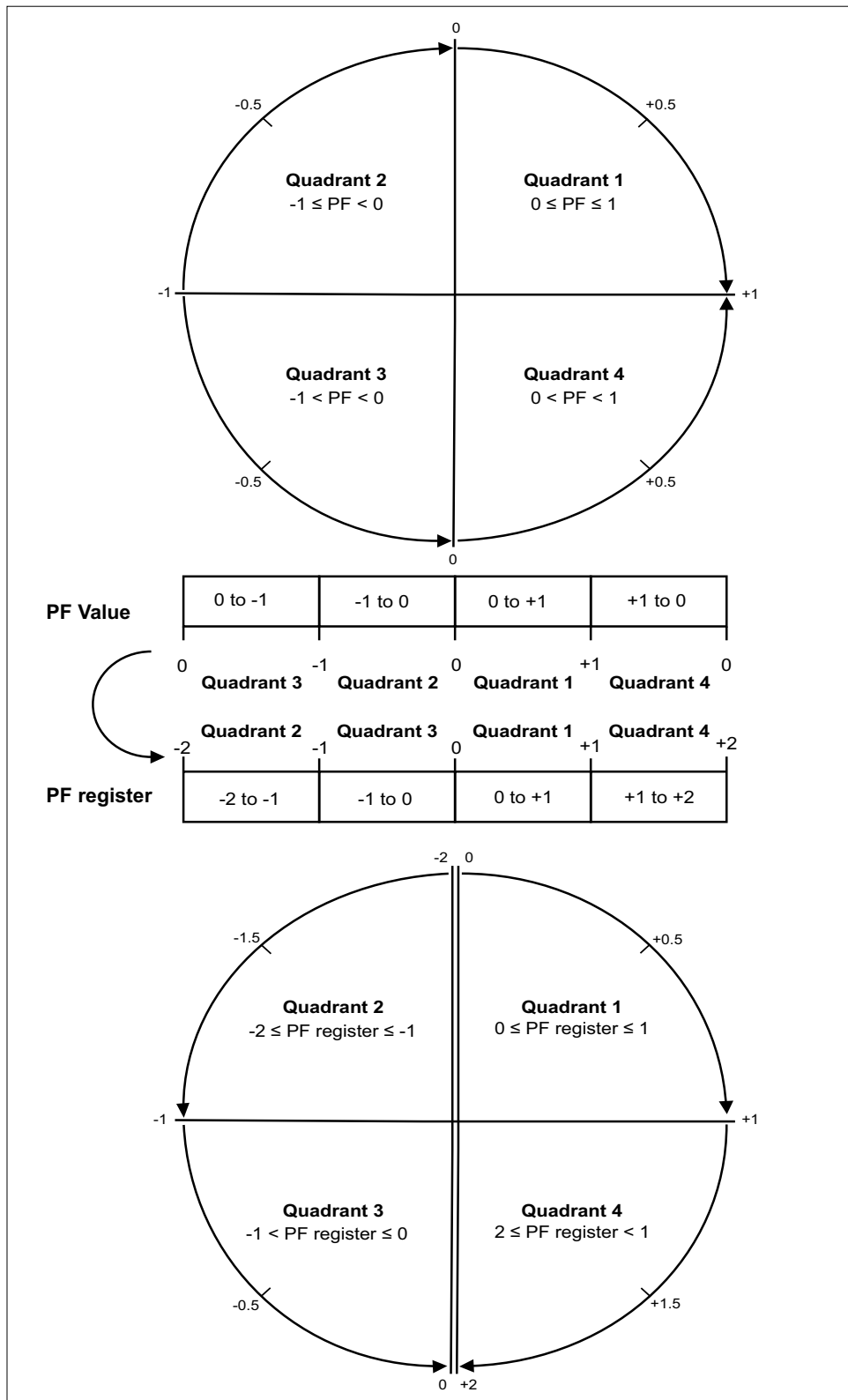

The PF value is calculated from the PF register value using the following formulas:

Quadrant	PF range	PF register range	PF formula
Quadrant 1	0 to +1	0 to +1	PF value = PF register value
Quadrant 2	-1 to 0	-2 to -1	PF value = (-2) - (PF register value)
Quadrant 3	0 to -1	-1 to 0	PF value = PF register value
Quadrant 4	+1 to 0	+1 to +2	PF value = (+2) - (PF register value)

Go to www.se.com and search for your meter's Modbus register list to download a copy.

Timers

The meter supports operating timer and load timer.

Operating timer

The operating timer (**Timer > Oper**) keeps track of how long the meter has been powered up.

Load timer

The load timer (**Timer > Load**) keeps track of how much time the input current exceeds the specified load timer setpoint current.

Resets

Meter resets

Resets allow you to clear various accumulated parameters stored on your meter or reinitialize the meter or meter accessories.

Meter resets clear your meter's onboard data logs and other related information. Resets are typically performed after you make changes to the meter's basic setup parameters (such as frequency, VT/PT or CT settings) to clear invalid or obsolete data in preparation for putting the meter into active service.

Meter Initialization

Meter Initialization is a special command that clears the meter's logged data, counters and timers.

It is common practice to initialize the meter after its configuration is completed, before adding it to an energy management system.

After configuring all the meter setup parameters, navigate through the different meter display screens and make sure the displayed data is valid then perform meter initialization.

Performing global resets using the display

Global resets allow you to clear all data of a particular type, such as all energy values or all minimum/maximum values.

1. Navigate to **Maint > Reset**.
2. Move the cursor to point to **Global Reset**, then press **Select**.
3. Move the cursor to point to the parameter you want to reset, then press **Reset**.

Option	Description
Meter Initialization	Clears all data listed in this table (energy, demand, min/max values, counters, logs and timers).
Energies	Clears all accumulated energy values (kWh, kVARh, kVAh).
Demands	Clears all the demand registers.
Min/Max	Clears all the minimum and maximum registers.
Alarm Counts & Logs	Clears all the alarm counters and alarm logs.

4. Enter the reset password (default is "0"), then press **OK**.
5. Press **Yes** to confirm the reset or **No** to cancel and return to the previous screen.

To perform resets using ION Setup, see the "PM5100" topic in the ION Setup online help or in the ION Setup device configuration guide, available from www.se.com.

Performing single resets using the display

Single resets allow you clear data only in a specific register or register type.

Single resets are often combined to allow you to clear all data of a similar type, for example, a kWh, kVAR and kVA reset may be combined into an energy reset that clears all of the meter's energy logs.

1. Navigate to **Maint > Reset**.
2. Move the cursor to point to **Single Reset**, then press **Select**.
3. Move the cursor to point to the parameter you want to reset, then press **Reset**.
If there are additional options for the parameter, press **Select**, move the cursor to point to the option you want, then press **Reset**.
4. Enter the reset password (default is “0”), then press **OK**.
5. Press **Yes** to confirm the reset or **No** to cancel and return to the previous screen.

Available single resets using the display

Parameter	Option	Description
Energy	Accumulated	Clears all accumulated energy values (kWh, kVARh, kVAh).
Demand	Power, Current	Select which demand registers to clear (power demand or current demand).
Alarms	Event Queue	Clears the alarm event queue register (active alarms list).
	History Log	Clears the alarm history log.
	Counters	Select Counters and then select which alarm counter to clear. See the Alarm counter reset options table.
Active Load Timer	—	Clears and restarts the load operation timer.

To perform resets using ION Setup, see the “PM5100” topic in the ION Setup online help or in the ION Setup device configuration guide, available from www.se.com.

Power quality

Power quality measurements

The meter measures voltage and current harmonics up to the 15th individual harmonic, and calculates Total Harmonic Distortion (THD, thd) and Total Demand Distortion (TDD) based on 31st harmonics.

Harmonics overview

Harmonics are integer multiples of the fundamental frequency of the power system.

Harmonics information is valuable for power quality analysis, determining properly rated transformers, maintenance and troubleshooting. Evaluation of harmonics is required for compliance to system power quality standards such as EN50160 and meter power quality standards such as IEC 61000-4-30.

Harmonics measurements include per-phase magnitudes and angles (relative to the fundamental frequency of the phase A voltage) for the fundamental and higher order harmonics relative to the fundamental frequency. The meter's power system setting defines which phases are present and determines how line-to-line or line-to-neutral voltage harmonics and current harmonics are calculated.

Harmonics are used to identify whether the supplied system power meets required power quality standards, or if non-linear loads are affecting your power system. Power system harmonics can cause current flow on the neutral conductor, and damage to equipment such as increased heating in electric motors. Power conditioners or harmonic filters can be used to minimize unwanted harmonics.

Total harmonic distortion %

Total harmonic distortion (THD%) is a measure of the total per-phase voltage or current harmonic distortion present in the power system.

THD% provides a general indication of the quality of a waveform. THD% is calculated for each phase of both voltage and current.

Total demand distortion

Total demand distortion (TDD) is the per-phase harmonic current distortion against the full load demand of the electrical system.

TDD indicates the impact of harmonic distortion in the system. For example, if your system is showing high THD values but a low demand, the impact of harmonic distortion on your system might be insignificant. However at full load, the THD value for the current harmonics is equal to TDD, so this could negatively impact your system.

Harmonic content calculations

Harmonic content (H_C) is equal to the RMS value of all the non-fundamental harmonic components in one phase of the power system.

The meter uses the following equation to calculate H_C :

$$H_C = \sqrt{(H_2)^2 + (H_3)^2 + (H_4)^2 \dots}$$

THD% calculations

THD% is a quick measure of the total distortion present in a waveform and is the ratio of harmonic content (H_C) to the fundamental harmonic (H_1).

By default, the meter uses the following equation to calculate THD%:

$$\text{THD} = \frac{H_C}{H_1} \times 100\%$$

thd calculations

thd is an alternate method for calculating total harmonic distortion that uses the RMS value for the total harmonic content rather than the fundamental content.

The meter uses the following equation to calculate thd:

$$\text{thd} = \frac{HC}{\sqrt{(H1)^2 + (HC)^2}} \times 100$$

TDD calculations

TDD (total demand distortion) evaluates the harmonic currents between an end user and a power source.

The harmonic values are based on a point of common coupling (PCC), which is a common point where each user receives power from the power source.

The meter uses the following equation to calculate TDD:

$$\text{TDD} = \left(\sqrt{(HCIA)^2 + (HCIB)^2 + (HCIC)^2} \right) / (I_{\text{Load}}) \times 100$$

Where I_{Load} is equal to the maximum demand load on the power system.

Viewing harmonics using the display

You can view harmonics data using the display.

1. Navigate to **Harm**.
The **Harmonics %** screen displays.
2. Press the voltage or current harmonics you want to view.

IEEE mode	IEC mode	Description
V L-L	U	Line-to-line voltage harmonics data
V L-N	V	Line-to-neutral voltage harmonics data
Amps	I	Current harmonics data
TDD	TDD	Total demand distortion data

The fundamental (1st) harmonics numeric magnitudes and angles for all phases are displayed.

- Press **3-11** or **7-15** to view the graphs for the 3rd to the 11th or 7th to 15th harmonics, respectively.

For example, to display the 7th to 15th harmonics screen, press **7-15**.

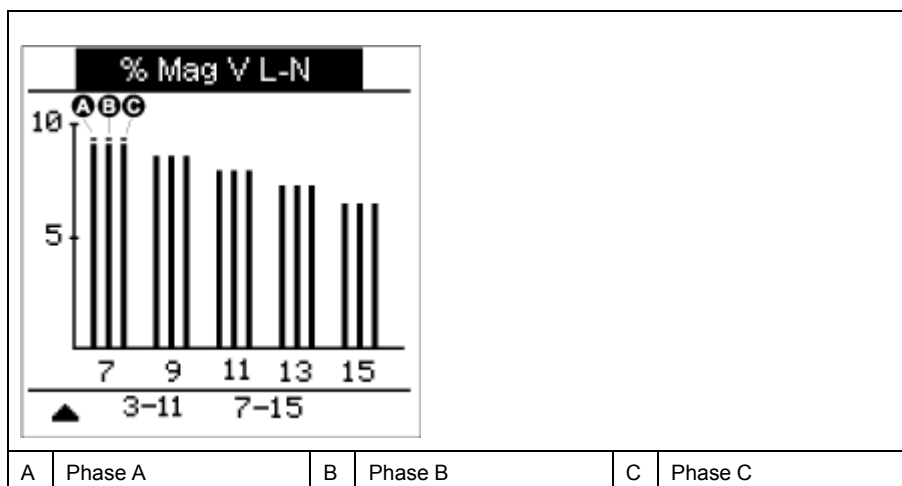

The vertical axis of the harmonics graph indicates the harmonic’s magnitude as a percentage of the fundamental harmonic, and is scaled based on the largest harmonic displayed. At the top of each vertical bar is a marker that shows the maximum value of the harmonic. If the harmonic is greater than the fundamental harmonic, this marker is triangular-shaped to show that the value is out of range.

Viewing TDD using the display

The meter display provides screens that show TDD values.

NOTE: Your meter’s Modbus map includes registers for harmonics data for integration into your power or energy management system. You can download the Modbus register list of your meter at www.se.com.

- Navigate to **Harm > TDD**.
The TDD information displays.
- Press the up arrow to return to the main display screens.

Viewing THD/thd using the display

You can view THD/thd data using the display.

NOTE: Your meter’s Modbus map includes registers for total harmonic distortion data for integration into your power or energy management system.

- Navigate to **THD** to view the **THD/thd Select** screen.
- Press **THD** to display values that use the calculation method based on the fundamental harmonic or **thd** to display values that use the calculation method based on the RMS value of all harmonics in that phase (including the fundamental).

IEEE mode	IEC mode	Description
Amps	I	Total harmonic distortion data for per phase and neutral currents.
V L-L	U	Total harmonic distortion data line-to-line voltage.
V L-N	V	Total harmonic distortion data line-to-neutral voltage.

3. Press the current or voltage THD or thd values you want to view.
The total harmonic distortion percentage values are displayed.
4. Press the up arrow to return to the main display screens.

Maintenance

Maintenance overview

The meter does not contain any user-serviceable parts. If the meter requires service, contact your local Schneider Electric Technical Support representative.

NOTICE

METER DAMAGE

- Do not open the meter case.
- Do not attempt to repair any components of the meter.

Failure to follow these instructions can result in equipment damage.

Do not open the meter. Opening the meter voids the warranty.

Power meter memory

The meter uses its nonvolatile memory to retain data and metering configuration values.

Under the operating temperature range specified for the power meter this nonvolatile memory has an expected life of at least 45 years.

NOTE: Life expectancy is a function of operating conditions and does not constitute any expressed or implied warranty.

Firmware version, model and serial number

You can view the meter model, serial number, date of manufacture, firmware version (including OS - Operating System and RS - Reset System), language version, and OS CRC (Cyclic Redundancy Check) from the display panel. The OS CRC value is a number (Hexadecimal format) that identifies the uniqueness between different OS firmware versions.

- Using the display panel: Navigate to **Maint > Diag > Info**.

Firmware upgrades

The power meter supports the downloading of new firmware and language files over the communications link.

This requires the free DLF3000 software, which is available at www.se.com. The DLF3000 offers an extensive Help file with information on operating the software. The most recent firmware and language files are also available on the website.

Upgrading your meter using DLF3000

Use the DLF3000 upgrade utility, available from www.se.com, to upgrade your meter's firmware files.

NOTE: Recommended baud rate for firmware download through communications link is 19200.

Before you begin, download the necessary files from www.se.com:

- Download the latest version of DLF3000 then install it on your computer.
- Download your meter's firmware.

To see if there are firmware upgrades available for your meter, search for your meter at www.se.com

1. Start DLF3000.
2. Click **Add/Update**.
3. Navigate to the folder where you saved your meter's firmware then select the firmware file and click **Open**.
4. Click **Next**.
5. Select a system to upgrade, or click **New** to define a new system.
6. Define the communications connection (click **Add** to create a new connection or **Configure** to update an existing connection).
 - a. Type in the box to assign a communications connection name and select a communications driver from the dropdown list (Modbus/TCP Driver or Serial Driver).
 - b. Click **Continue**.

A dialog box appears where you need to provide the communications information for the meter.

 - If you are using Modbus over TCP to upgrade, type the meter's IP address in the box.
 - If you are using a serial connection, enter the information on how your meter is connected (such as communications wiring, parity, port, address).
 - c. Click **OK**.
7. Define the devices to upgrade.
 - a. Click **Add**.
 - b. Type in a device name.
 - c. Select the device type from the list.
 - d. Select the connection name for the communications connection used with the device (the one you defined in the previous step).
 - e. Click **OK**.
 - f. Enter in the device address and protocol information then click **OK**.
8. Click **Next**.
9. Select the device name from the **Download Candidate Devices** pane, then click the right arrow button to move the selection to the **Download Target Devices** pane.
10. Select the meter firmware in the **Firmware to** field.
11. Click **Next**.
12. Click **Health Check** to confirm the meter is communicating.

The Health Status shows Passed to indicate successful communications.
13. Click **Next**.

The **Firmware Update Group** shows the connection name, the firmware version and status (should be "Queued"). The **Group Device List** shows the device or devices being upgraded.
14. Click **Download**.

NOTE: A warning message displays, "Warning: Relays on PowerLogic Metering Devices will be de-energized if selected for download and will remain in this mode until a successful download is completed. Press OK to start the download."

15. Click **OK**.

- The Firmware Upgrade Group status changes to Active, then updates to show the current upgrade progress (in percent complete).
- The Group Device List status shows “Entering Download Mode”, then changes to “Downloading” when the firmware is being downloaded to the meter. “Estimated Time Remaining” shows the firmware download progress.
- You can also check the progress on meters equipped with a display panel. The meter display shows “Download in progress” and a shows a dynamically incrementing number for “Percent Complete” (up to 100%).

When the firmware upgrade is complete, the Firmware Update Group status shows Complete (Passed). The Group Device List status shows Successful Download.

16. Click **Finished**.

To exit the download firmware program, click **Yes** when prompted to quit DLF.

Diagnostics information

The diagnostics screen provides meter information, status and event data for troubleshooting.

Navigate to **Maint > Diag > Meter** to view details of the meter status.

Navigate to **Maint > Diag > CI Pwr** to view the control power information.

- **Non-MID meter models** : The CI Pwr screen displays how many times the meter lost control power, and the date and time of its last occurrence.
- **MID meter models** : The CI Pwr screen displays how many times the meter lost control power (auxiliary power), and the last power up and power down events with the timestamp.

Navigate to **Maint > Diag > PhAng** to view the angle between voltage and current for all three phases of the power system the meter is monitoring.

Control power (auxiliary power) interruption event

For MID compliant models.

When the meter is in OFF state and control power supply is applied OR when the meter is in ON state and the control power is cycled:

- If the 4-digit **MID/Revenue Lock** is enabled, an icon  which indicates the control power loss blinks on the top right corner of the screen.
- When the meter is in ON state and the control power goes below the operating range, the meter logs the **Last Power Down** event with timestamp before power-off.
- When the meter is in OFF state and the control power is applied, the meter logs the **Last Power Up** event with timestamp after power-on.
- When there are multiple events along with control power interruption event, then the control power interruption event icon blinks taking precedence over all other icons.

NOTE: The meter displays only the **Number of Losses**, the **Last Power Down** and **Last Power Up** events. The last 20 control power interruption event logs (10 **Power Down** and 10 **Power Up** events) can be read only through communication.

Acknowledging control power (auxiliary power) interruption event using the display

For MID compliance on applicable models.

NOTE: When the control power interruption event icon displays on the meter, the facility manager must assess the reason and its duration.

Use the **CI Pwr** screen to acknowledge the control power interruption event.

You can acknowledge (dismiss) the control power interruption event only after entering the 4-digit MID/**Revenue Lock** password.

NOTE:

- You cannot acknowledge the alarms and the control power interruption events at the same time.
- The control power interruption event icon  blinks until you acknowledge the **Number of Losses**, the **Last Power Up** and **Last Power Down** events.

1. Navigate to **Maint > Diag > CI Pwr**.

The **Number of Losses**, the **Last Power Up** and **Last Power Down** events with the timestamp are displayed on the same page.

2. Press **Ack**.
3. Enter the **Revenue Lock** password, then press **OK**.

NOTE: The default password is **0000**.

4. Read the **Attention!** message on the display and press **Yes** to acknowledge or press **No** to go back to previous screen.

The **Ack** and control power interruption event icon  disappears only when you press **Yes**.

NOTE: You can reset the **Number of Losses** to **0** only through the Modbus communication. To perform this reset, you need to disable the 4-digit MID/**Revenue Lock** password in the meter HMI.

Troubleshooting

LED indicators

Abnormal heartbeat / serial communications LED behavior could mean potential problems with the meter.

Problem	Probable causes	Possible solutions
LED flash rate does not change when data is sent from the host computer.	Communications wiring	If using a serial-to-RS-485 converter, trace and check that all wiring from the computer to the meter is properly terminated.
	Internal hardware problem	Perform a hard reset: turn off control power to the meter, then re-apply power. If the problem persists, contact Technical Support.
Heartbeat / serial communications LED remains lit and does not flash ON and OFF	Internal hardware problem	Perform a hard reset: turn off control power to the meter, then re-apply power. If the problem persists, contact Technical Support.
Heartbeat / serial communications LED flashes, but the display is blank.	Display setup parameters incorrectly set	Review display parameter setup.

If the problem is not fixed after troubleshooting, contact Technical Support for help. Make sure you have your meter’s firmware version, model and serial number information available.

Troubleshooting checks

There are some checks you can perform to try to identify potential issues with the meter's operation.

The following table describes potential problems, their possible causes, checks you can perform or possible solutions for each. After referring to this table, if you cannot resolve the problem, contact your local Schneider Electric sales representative for assistance.

⚠ ⚠ DANGER

HAZARD OF ELECTRIC SHOCK, EXPLOSION, OR ARC FLASH

- Apply appropriate Personal Protective Equipment (PPE) and follow safe electrical work practices. See NFPA 70E, CSA Z462 or other local standards.
- This equipment must be installed and serviced only by qualified personnel.
- Turn off all power supplying this device and the equipment in which it is installed before working on or in the equipment.
- Always use a properly rated voltage sensing device to confirm that all power is off.
- Assume communications and I/O wiring are hazardous live until determined otherwise.
- Do not use the data from the meter to confirm power is off.

Failure to follow these instructions will result in death or serious injury.

Potential problem	Possible cause	Possible solution
The maintenance (wrench) icon is illuminated on the power meter display.	When the maintenance (wrench) icon is illuminated, it indicates an event has occurred which may require attention.	Go to Maint > Diag . Event messages display to indicate the reason the icon is illuminated. Note these event messages and call the Technical Support or contact your local sales representative for assistance.
The display is blank after applying control power to the power meter.	The power meter may not be receiving the necessary power.	The display may have timed out. Verify that the power meter line and terminals are receiving the necessary power. Verify that the heartbeat LED is blinking. Press a button to see if the display timed out.
The data being displayed is inaccurate or not what you expect.	<ul style="list-style-type: none"> Incorrect setup values. Incorrect voltage inputs. Power meter is wired improperly 	<ul style="list-style-type: none"> Check that the correct values have been entered for power meter setup parameters (CT and VT ratings, Nominal Frequency, and so on). Check power meter voltage input terminals (1, 2, 3, 4) to verify that adequate voltage is present. Check that all CTs and VTs are connected correctly (proper polarity is observed) and that they are energized. Check shorting terminals. See the recommended torque in the Wiring section of the installation manual.

Potential problem	Possible cause	Possible solution
Cannot communicate with power meter from a remote personal computer.	<ul style="list-style-type: none"> • Power meter address is incorrect. • Power meter baud rate is incorrect. • Communications lines are improperly connected. • Communications lines are improperly terminated. • Incorrect route statement to power meter. 	<ul style="list-style-type: none"> • Check to see that the power meter is correctly addressed. • Verify that the baud rate of the power meter matches the baud rate of all other devices on its communications link. • Verify the power meter communications connections. • Check to see that a multi-point communications terminator is properly installed. • Check the route statement. Contact Global Technical Support for assistance.
Energy/Alarm LED not working.	May have been disabled by user.	Confirm that the energy / alarm LED is configured correctly.

Technical assistance

Visit www.se.com for support and assistance with lost passwords or other technical problems with the meter.

Make sure you include your meter's model, serial number and firmware version in your email or have it readily available if calling Technical Support.

Verifying accuracy

Overview of meter accuracy

All meters are tested and verified at the factory in accordance with International Electrotechnical Commission (IEC) and American National Standards Institute (ANSI) standards.

Your digital power meter typically does not require re-calibration. However, in some installations a final accuracy verification of the meters is required, especially if the meters will be used for revenue or billing applications.

For a list of accuracy standards that your meter complies to, contact your local Schneider Electric representative or download the meter brochure from www.se.com.

Accuracy test requirements

The most common method for testing meter accuracy is to apply test voltages and currents from a stable power source and compare the meter's readings with readings from a reference device or energy standard.

Signal and power source

The meter maintains its accuracy during voltage and current signal source variations but its energy pulsing output needs a stable test signal to help produce accurate test pulses. The meter's energy pulsing mechanism needs approximately 10 seconds to stabilize after every source adjustment.

The meter must be connected to control power in order to conduct accuracy verification testing. Refer to your meter's installation documentation for power supply specifications.

DANGER

HAZARD OF ELECTRIC SHOCK, EXPLOSION, OR ARC FLASH

Verify the device's power source meets the specifications for your device's power supply.

Failure to follow these instructions will result in death or serious injury.

Control equipment

Control equipment is required for counting and timing the pulse outputs from an energy pulsing LED or digital output.

- Most standard test benches have an arm equipped with optical sensors to detect LED pulses (the photodiode circuitry converts detected light into a voltage signal).
- The reference device or energy standard typically has digital inputs that can detect and count pulses coming from an external source (i.e., the meter's digital output).

NOTE: The optical sensors on the test bench can be disrupted by strong sources of ambient light (such as camera flashes, florescent tubes, sunlight reflections, floodlights, etc.). This can cause test errors. Use a hood, if necessary, to block out ambient light.

Environment

The meter should be tested at the same temperature as the testing equipment. The ideal temperature is about 23 °C (73 °F).

A warm-up time of 30 minutes is recommended before beginning energy accuracy verification testing. At the factory, the meters are warmed up to their typical operating temperature before calibration to help ensure that the meters will reach their optimal accuracy at operating temperature.

Most high precision electronic equipment requires a warm up time before it reaches its specified performance levels.

Reference device or energy standard

To help ensure the accuracy of the test, it is recommended that you use a reference device or reference energy standard with a specified accuracy that is 6 to 10 times more accurate than the meter under test. Before you start testing, the reference device or energy standard should be warmed up as recommended by the manufacturer.

NOTE: Verify the accuracy and precision of all measurement equipment used in accuracy testing (for example, voltmeters, ammeters, power factor meters).

Energy pulsing

You can configure the meter's alarm /energy LED or the digital output(s) for energy pulsing.

- The meter is equipped with an alarm / energy pulsing LED. When configured for energy pulsing, the LED emits pulses that are then used to determine the accuracy of the meter's energy measurements.
- The meter sends the pulses from the configured digital output(s) port, which are then used to determine the accuracy of the meter's energy measurements by pulse counter.

Meter settings for accuracy testing

Your meter's power system and other parameters must be configured for accuracy testing.

Meter parameter	Value
Power system	3PH4W Wye Gnd (3-phase, 4 wire Wye with ground)
Energy pulse constant (alarm/energy pulsing LED or digital output)	In sync with reference test equipment

Verifying accuracy test

The following tests are guidelines for accuracy testing your meter; your meter shop may have specific testing methods.

⚠ ⚠ DANGER

HAZARD OF ELECTRIC SHOCK, EXPLOSION, OR ARC FLASH

- Apply appropriate Personal Protective Equipment (PPE) and follow safe electrical work practices. See NFPA 70E, CSA Z462 or other local standards.
- Turn off all power supplying this device and the equipment in which it is installed before working on or in the equipment.
- Always use a properly rated voltage sensing device to confirm that all power is off.
- Do not exceed the maximum ratings of this device.
- Verify the device’s power source meets the specifications for your device’s power supply.

Failure to follow these instructions will result in death or serious injury.

1. Turn off all power supplying this device and the equipment in which it is installed before working on the device or equipment.
2. Use a properly rated voltage sensing device to confirm that all power is off.
3. Connect the test voltage and current source to the reference device or energy standard. Ensure all voltage inputs to the meter under test are connected in parallel and all current inputs are connected in series.

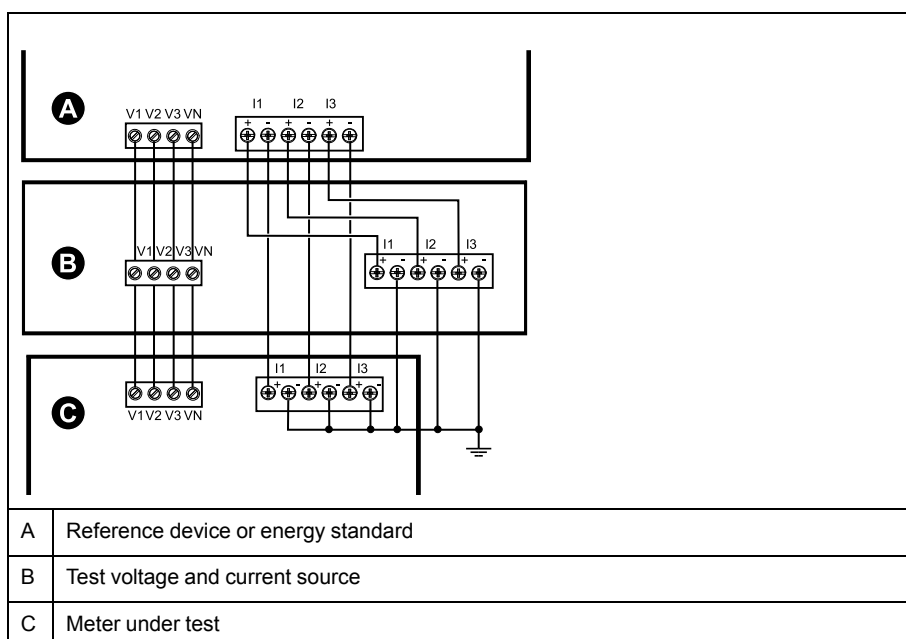

4. Connect the control equipment used for counting the standard output pulses using one of these methods:

Option	Description
Energy pulsing LED	Align the red light sensor on the standard test bench armature over the energy pulsing LED.
Digital output	Connect the meter’s digital output to the standard test bench pulse counting connections.

NOTE: When selecting which method to use, be aware that energy pulsing LEDs and digital output(s) have different pulse rate limits.

5. Before performing the verification test, let the test equipment power up the meter and apply voltage for at least 30 seconds. This helps stabilize the internal circuitry of the meter.
6. Configure the meter’s parameters for verifying accuracy testing.

7. Depending on the method selected for counting the energy pulses, configure the meter's energy pulsing LED or one of the digital output(s) to perform energy pulsing. Set the meter's energy pulse constant so it is in sync with the reference test equipment.
8. Perform accuracy verification on the test points. Run each test point for at least 30 seconds to allow the test bench equipment to read an adequate number of pulses. Allow 10 seconds of dwell time between test points.

Required pulses calculation for accuracy verification testing

Accuracy verification test equipment typically requires you to specify the number of pulses for a specific test duration.

The reference test equipment typically requires you to specify the number of pulses required for a test duration of "t" seconds. Normally, the number of pulses required is at least 25 pulses, and the test duration is greater than 30 seconds.

Use the following formula to calculate the required number of pulses:

$$\text{Number of pulses} = P_{\text{tot}} \times K \times t / 3600$$

Where:

- P_{tot} = total instantaneous power in kilowatts (kW)
- K = the meter's pulse constant setting, in pulses per kWh
- t = test duration, in seconds (typically greater than 30 seconds)

Total power calculation for accuracy verification testing

Accuracy verification testing supplies the same test signal (total power) to both the energy reference/standard and the meter under test.

Total power is calculated as follows, where:

- P_{tot} = total instantaneous power in kilowatts (kW)
- V_{LN} = test point line-to-neutral voltage in volts (V)
- I = test point current in amps (A)
- PF = power factor

The result of the calculation is rounded up to the nearest integer.

For a balanced 3-phase Wye system:

$$P_{\text{tot}} = 3 \times V_{\text{LN}} \times I \times PF \times 1 \text{ kW}/1000 \text{ W}$$

NOTE: A balanced 3-phase system assumes that the voltage, current and power factor values are the same for all phases.

For a single-phase system:

$$P_{\text{tot}} = V_{\text{LN}} \times I \times PF \times 1 \text{ kW}/1000 \text{ W}$$

Percentage error calculation for accuracy verification testing

Accuracy verification testing requires you to calculate the percentage error between the meter being tested and the reference/standard.

Calculate the percentage error for every test point using the following formula:

$$\text{Energy error} = (EM - ES) / ES \times 100\%$$

Where:

- EM = energy measured by the meter under test
- ES = energy measured by the reference device or energy standard.

NOTE: If accuracy verification reveals inaccuracies in your meter, they may be caused by typical sources of test errors. If there are no sources of test errors present, please contact your local Schneider Electric representative.

Accuracy verification test points

The meter should be tested at full and light loads and at lagging (inductive) power factors to help ensure testing over the entire range of the meter.

The test amperage and voltage input rating are labeled on the meter. Refer to the installation sheet or data sheet for your meter’s nominal current, voltage and frequency specifications.

Watt-hour test point	Sample accuracy verification test point
Full load	100% to 200% of the nominal current, 100% of the nominal voltage and nominal frequency at unity power factor or one (1).
Light load	10% of the nominal current, 100% of the nominal voltage and nominal frequency at unity power factor or one (1).
Inductive load (lagging power factor)	100% of the nominal current, 100% of the nominal voltage and nominal frequency at 0.50 lagging power factor (current lagging voltage by 60° phase angle).

VAR-hour test point	Sample accuracy verification test point
Full load	100% to 200% of the nominal current, 100% of the nominal voltage and nominal frequency at zero power factor (current lagging voltage by 90° phase angle).
Light load	10% of the nominal current, 100% of the nominal voltage and nominal frequency at zero power factor (current lagging voltage by 90° phase angle).
Inductive load (lagging power factor)	100% of the nominal current, 100% of the nominal voltage and nominal frequency at 0.87 lagging power factor (current lagging voltage by 30° phase angle).

Energy pulsing considerations

The meter’s alarm / energy LED and digital output(s) are capable of energy pulsing within specific limits.

Description	Alarm / energy LED	Digital output
Maximum pulse frequency	2.5 kHz	25 Hz
Minimum pulse constant	1 pulse per k_h	
Maximum pulse constant	9,999,999 pulses per k_h	

The pulse rate depends on the voltage, current and PF of the input signal source, the number of phases, and the VT and CT ratios.

If P_{tot} is the instantaneous power (in kW) and K is the pulse constant (in pulses per k_h), then the pulse period is:

$$\text{Pulse period (in seconds)} = \frac{3600}{K \times P_{tot}} = \frac{1}{\text{Pulse frequency (Hz)}}$$

VT and CT considerations

Total power (P_{tot}) is derived from the values of the voltage and current inputs at the secondary side, and takes into account the VT and CT ratios.

The test points are always taken at the secondary side, regardless of whether VTs or CTs are used.

If VTs and CTs are used, you must include their primary and secondary ratings in the equation. For example, in a balanced 3-phase Wye system with VTs and CTs:

$$P_{tot} = 3 \times V_{LN} \times \frac{V_{T_p}}{V_{T_s}} \times I \times \frac{C_{T_p}}{C_{T_s}} \times PF \times \frac{1 \text{ kW}}{1000 \text{ W}}$$

where P_{tot} = total power, V_{T_p} = VT primary, V_{T_s} = VT secondary, C_{T_p} = CT primary, C_{T_s} = CT secondary and PF = power factor.

Total power limits

There are limits to the total power that the alarm / energy pulsing LED and the digital output can handle.

Total power limit for alarm / energy LED

Given the maximum pulse constant (Kmax) you can enter is 9,999,999 pulses per kWh, and the maximum pulse frequency for the alarm / energy LED is 83 Hz, the maximum total power (Max P_{tot}) the alarm / energy LED's energy pulsing circuitry can handle is 29.88 Watts:

- Maximum P_{tot} = $3600 \times (\text{Maximum pulse frequency}) / K_{max} = 3600 \times 83 / 9,999,999 = 0.02988 \text{ kW}$

Total power limit for digital output

Given the maximum pulse constant (Kmax) you can enter is 9,999,999 pulses per kWh, and the maximum pulse frequency for the digital output is 25 Hz, the maximum total power (Max P_{tot}) the digital output's energy pulsing circuitry can handle is 9 Watts:

- Maximum P_{tot} = $3600 \times (\text{Maximum pulse frequency}) / K_{max} = 3600 \times 25 / 9,999,999 = 0.009 \text{ kW}$

Typical sources of test errors

If you see excessive errors during accuracy testing, examine your test setup and test procedures to eliminate typical sources of measurement errors.

Typical sources of accuracy verification testing errors include:

- Loose connections of voltage or current circuits, often caused by worn-out contacts or terminals. Inspect terminals of test equipment, cables, test harness and the meter under test.
- Meter ambient temperature is significantly different than 23 °C (73 °F).
- Floating (ungrounded) neutral voltage terminal in any configuration with unbalanced phase voltages.
- Inadequate meter control power, resulting in the meter resetting during the test procedure.
- Ambient light interference or sensitivity issues with the optical sensor.
- Unstable power source causing energy pulsing fluctuations.
- Incorrect test setup: not all phases connected to the reference device or the energy standard. All phases connected to the meter under test should also be connected to the reference meter/standard.
- Moisture (condensing humidity), debris or pollution present in the meter under test.

MID compliance

Protected setup parameters and functions

Your meter has features and settings that cannot be changed while the meter is revenue-locked. In order to prevent modifications to revenue-related settings and data on your meter, some of the features and parameters on your meter cannot be edited once the meter is revenue-locked.

Protected setup parameters

Settings	Protected status	Description
Power system settings	Yes	You cannot change any power system settings while the meter is locked (for example, power system type, VT and CT connections, VT and CT primary and secondary values, system frequency and phase rotation) NOTE: For MID compliance, the Power System must be set to either 3PH4W Wye Gnd (three-phase 4-wire wye grounded) or 3PH3W Dlt Ungnd (three-phase 3-wire delta ungrounded)
Meter label	Yes	You cannot change the meter label while the meter is locked
Meter time settings	Yes	You cannot change the meter's date while the meter is locked
Energy pulsing	Yes	The alarm / energy pulsing LED on the MID-compliant models is permanently set for energy pulsing and cannot be disabled or used for alarms. All other setup parameters for the energy pulsing LED are also permanently set and cannot be modified.
Energy reset password	Yes	You cannot change the energy reset password while the meter is locked

Protected functions

After the meter is locked, the following resets are disabled:

- Global resets: Meter Initialization (all) and Energies
- Single resets: Energy and Multi-Tariff

For a complete list of protected functions and settings, see your meter's Modbus register list, available from www.se.com.

Locking or unlocking the meter

After you initialize the meter, you must lock it in order to conform to MID standards.

Before you lock your meter:

- Make sure you have completed all necessary configuration.
- Perform a meter initialization reset to clear any previously accumulated meter data.

A lost lock password cannot be recovered.

NOTICE

PERMANENTLY LOCKED DEVICE

Record your device's user and password information in a secure location.

Failure to follow these instructions can result in data loss.

1. Navigate to **Maint > Setup > Meter > Lock**.
2. Press **Edit** to activate or deactivate the lock.
3. Enter your lock password.
NOTE: The default password is 0000.
4. Press **+** and **-** to scroll between **Active** and **Inactive**.
5. Press **OK** to select the option.
6. Select **Yes** to confirm the selected option, and exit the screen.
7. Make sure you record and store the lock password in a secure location.
On activating the lock, a lock icon appears on the upper left corner of the screen.
NOTE: Make sure you record and store the lock password in a secure location. A lost lock password cannot be recovered.

Setting up the lock password

You can change the lock password on the meter.

NOTE: You cannot change the lock password when the lock is active. To change the password, make sure the lock is inactive.

A lost lock password cannot be recovered.

NOTICE

PERMANENTLY LOCKED DEVICE

Record your device's user and password information in a secure location.

Failure to follow these instructions can result in data loss.

1. Navigate to **Maint > Setup > HMI > Pass**.
2. Press the down arrow to scroll to **Passwords > Revenue Lock** screen.
3. Press **Edit** to select a password.
4. Press **+** to increment the active digit through the numerals 0-9.
5. Press the left arrow to move to the next digit to the left.
6. Continue until all values are selected, and then press **OK** to set the password.
7. Press **Yes** to save the changes.

Device specifications

The specifications contained in this section are subject to change without notice.

Mechanical characteristics

IP degree of protection (IEC 60529)	Display: IP54 (Upgrade to IP65 with optional accessory kit METSEIP65OP96X96FF) Meter body: IP30
Mounting position	Vertical
Display type	Monochrome graphics LCD, 128 x 128 resolution
Display backlight	White LED
Viewable area	67 x 62.5 mm (2.64 x 2.46 in)
Weight	380 g
Dimensions W x H x D [protrusion from cabinet]	96 x 96 x 72 mm (depth of meter from housing mounting flange) [13 mm]
Panel thickness	6 mm maximum

Electrical characteristics

Measurement accuracy

- Measurement type: True RMS on three-phase (3P, 3P + N); 64 samples per cycle, zero blind
- IEC 61557-12: PMD/[SD]/K70/0.5 (for firmware version 1.1.1 and higher)

Measurement type	Class of accuracy as per IEC 61557-12 (for firmware version 1.1.1 and higher)	Error
Active energy	Class 0.5S (Class 0.5S as per IEC 62053-22 at 5 A $I_{nominal}$ (for 1 A $I_{nominal}$ when $I > 0.15$ A))	±0.5%
Reactive energy	Class 2 (Class 2 as per IEC 62053-23 at 5 A $I_{nominal}$ (for 1 A $I_{nominal}$ when $I > 0.15$ A))	±2%
Apparent energy	Class 0.5	±0.5%
Active power	Class 0.5	±0.5%
Reactive power	Class 2	±2%
Apparent power	Class 0.5	±0.5%
Current	Class 0.5	±0.5%
Voltage (L-N)	Class 0.5	±0.5%
Frequency	Class 0.05	±0.05%
Power factor	Class 0.5	±0.005 Count

Power quality accuracy

Measurement type	Class of accuracy as per IEC 61557-12 (for firmware version 1.1.1 and higher)	Error
Voltage harmonics	Class 5	±5%
Voltage THD/thd	Class 5	±5%
Current harmonics	Class 5	±5%
Current THD	Class 5	±5%

Voltage inputs

Maximum VT/PT primary	1.0 MV AC
Specified accuracy range	UL: 20-347 V L-N/35-600 V L-L IEC: 20-400 V L-N/35-690 V L-L (absolute range 35 V L-L to 760 V L-L)
Impedance	5 MΩ
Frequency	Measured: 45 to 65 Hz Nominal: 50 / 60 Hz
Burden	< 0.2 VA at 240 V AC L-N

Current inputs

CT secondary	Nominal: 5 A or 1 A
Measured current	50 mA to 8.5 A
Starting current	5 mA
Withstand	20 A continuous 50 A at 10 sec/hr 500 A at 1 sec/hr
Impedance	< 0.3 mΩ
Frequency	Measured: 45 to 65 Hz Nominal: 50 / 60 Hz
Burden	< 0.026 VA at 8.5 A

AC control power

Operating range	100 – 277 V AC L-N / 100 – 415 V L-L ±10%
Installation category	CAT III 300 V class per IEC 61010
Burden	5 W / 11 VA max at 415 V L-L
Frequency	50/60 Hz ± 5 Hz
Ride-through time	80 ms typical at 120V AC and maximum burden 100 ms typical at 230 V AC and maximum burden 100 ms typical at 415 V AC and maximum burden

DC control power

Operating range	125 – 250 V DC ±20%
Burden	< 4 W at 250 V DC
Ride-through time	50 ms typical at 125 V DC and maximum burden

Digital output

Number	1
Maximum load voltage	40 V DC
Maximum load current	20 mA
ON resistance	50 Ω maximum
Pulse frequency	≤ 25 Hz
Meter constant	from 1 to 9,999,999 pulses per k _h (k _h = kWh, kVARh or kVAh depending on the energy parameter selected)
Pulse width	50% duty cycle >20 ms

Digital output (Continued)

Leakage current	0.03 μ A
Isolation	5 kV rms

Environmental characteristics

Operating temperature	Meter: -25 to 70 °C (-13 to 158 °F) Display: -20 to 70 °C (-4 to 158 °F) Display functions to -25 °C (-13 °F) with reduced performance
Storage temperature	-40 to 85 °C (-40 to 185 °F)
Humidity rating	Operating: 5 – 95% RH non-condensing at 50 °C (122 °F)
Pollution degree	2
Altitude	2000 m CAT III
Location	Not suitable for wet locations For indoor use only
Product life	> 15 years

LEDs**LED indicators**

Heartbeat / communications activity	Green LED
Alarm / energy pulsing LED	Amber LED

Alarm / energy pulsing LED

Type	Amber LED, optical
Pulse frequency	50 Hz maximum
Pulse width	50% duty cycle (200 μ s minimum ON time)
Meter constant	from 1 to 9,999,999 pulses per k _h (k _h = kWh, kVARh or kVAh depending on the energy parameter selected) Fixed at 10,000 pulses per kWh on MID meter models
Wavelength	590 to 635 nm

EMC (electromagnetic compatibility)

Product standards	IEC 61557-12 (IEC 61326-1), IEC 62052-11 and EN50470
Immunity to electrostatic discharge	IEC 61000-4-2
Immunity to radiated fields	IEC 61000-4-3
Immunity to fast transients	IEC 61000-4-4
Immunity to surges	IEC 61000-4-5
Immunity to voltage dips and interruptions	IEC 61000-4-11
Immunity to magnetic fields	IEC 61000-4-8

Immunity to conducted disturbances, 150 kHz to 80 MHz	IEC 61000-4-6
Radiated and conducted emissions	FCC part 15 Class B, EN55022 Class B

Safety

Europe	CE, as per IEC 61010-1 (3rd Edition), IEC 62052- 11 & IEC61557-12 (for firmware version 1.1.1 and higher)
U.S. and Canada	cULus as per UL61010-1 (3rd Edition) CAN/CSA-C22.2 No. 61010-1 (3rd Edition)
Measurement category (voltage and current inputs)	CAT III up to 400 V L-N / 690 V L-L
Dielectric	As per IEC/UL 61010-1 (3rd Edition)
Protective class	Protective Class II Double insulated for user-accessible parts

MID compliance

Additional specifications apply to the MID meter PM5111.

Applicable MID standards and class index	<ul style="list-style-type: none"> EN 50470-1:2006 Class C EN 50470-3:2006 Class C
Type of measuring equipment	Static watt-hour meter
Intended use	Indoor use only, permanently mounted in residential, commercial or light industrial applications, where levels of vibration and shock are of low significance
Mechanical environment	M1
Electromagnetic (EMC) environment	E2
Applicable measurements	C(kWh)
Voltage at voltage terminals	<ul style="list-style-type: none"> 3-phase 4-wire Wye grounded: 3 x 63.5(110) to 3 x 277(480) V AC 3-phase 3-wire Delta ungrounded: 3 x 110 to 3 x 480 V L-L
Current Rating (I _{min} – I _{ref} (I _{max}))	0.05-5(6) A
Electrical network frequency	50 Hz
Impulse voltage rating	6 kV
AC voltage rating	4 kV
Main cover sealing type	Wire and crimp

RS-485 communications

Number of ports	1 (Only PM5110 and PM5111)
Maximum cable length	1219 m (4000 ft)
Maximum number of devices (unit loads)	Up to 32 devices on the same bus
Parity	Even, Odd, None (1 stop bit for Odd or Even parity; 2 stop bits for None)
Baud rate	9600, 19200, 38400 baud
Protocol	Modbus RTU, Modbus ASCII (7 or 8 bit), JBUS
Isolation	2.5 kV RMS, double insulated

China Standard Compliance

This product complies with the following standard(s) in China:

IEC 62053-22:2003 Electricity metering equipment (a.c.) - Particular requirements - Part 22: Static meters for active energy (classes 0,2 S and 0,5 S)

IEC 61557-12:2007 Electrical safety in low voltage distribution systems up to 1 000 V a.c. and 1 500 V d.c. - Equipment for testing, measuring or monitoring of protective measures - Part 12: Performance measuring and monitoring devices

GB/T 22264.7-2008 安装式数字显示电测量仪表 第7部分：多功能仪表的特殊要求

Schneider Electric
35 rue Joseph Monier
92500 Rueil Malmaison
France

+ 33 (0) 1 41 29 70 00

www.se.com

As standards, specifications, and design change from time to time,
please ask for confirmation of the information given in this publication.

© 2021 – Schneider Electric. All rights reserved.

EAV15105-EN09