

# FROG collection

DECORATIVE OUTDOOR LIGHTING

Sara Moroni



DECORATIVE OUTDOOR LIGHTING

floodlight  
downlight  
applique  
linear support  
box  
spike  
bollard  
floor

Extremely flexible family based on the idea of a round spot using a very elegant joint connecting to the vertical unit. The pole gives infinite adjustments on all axes. Frog is extremely detailed and painstaking in elegance with a spiral design on the back of the spot that, in addition to giving shape, maximises heat dissipation. With the projector version, Frog is able to guarantee an excellent luminous efficiency despite the aesthetically compact body. The new linear support is available in addition to the countless accessories and allows the installation of several frog heads, up to a maximum of four, on a single rod. Furthermore, a new box for ceiling or wall installation is now available; through an adjustable arm, it can hold up two Frog heads.





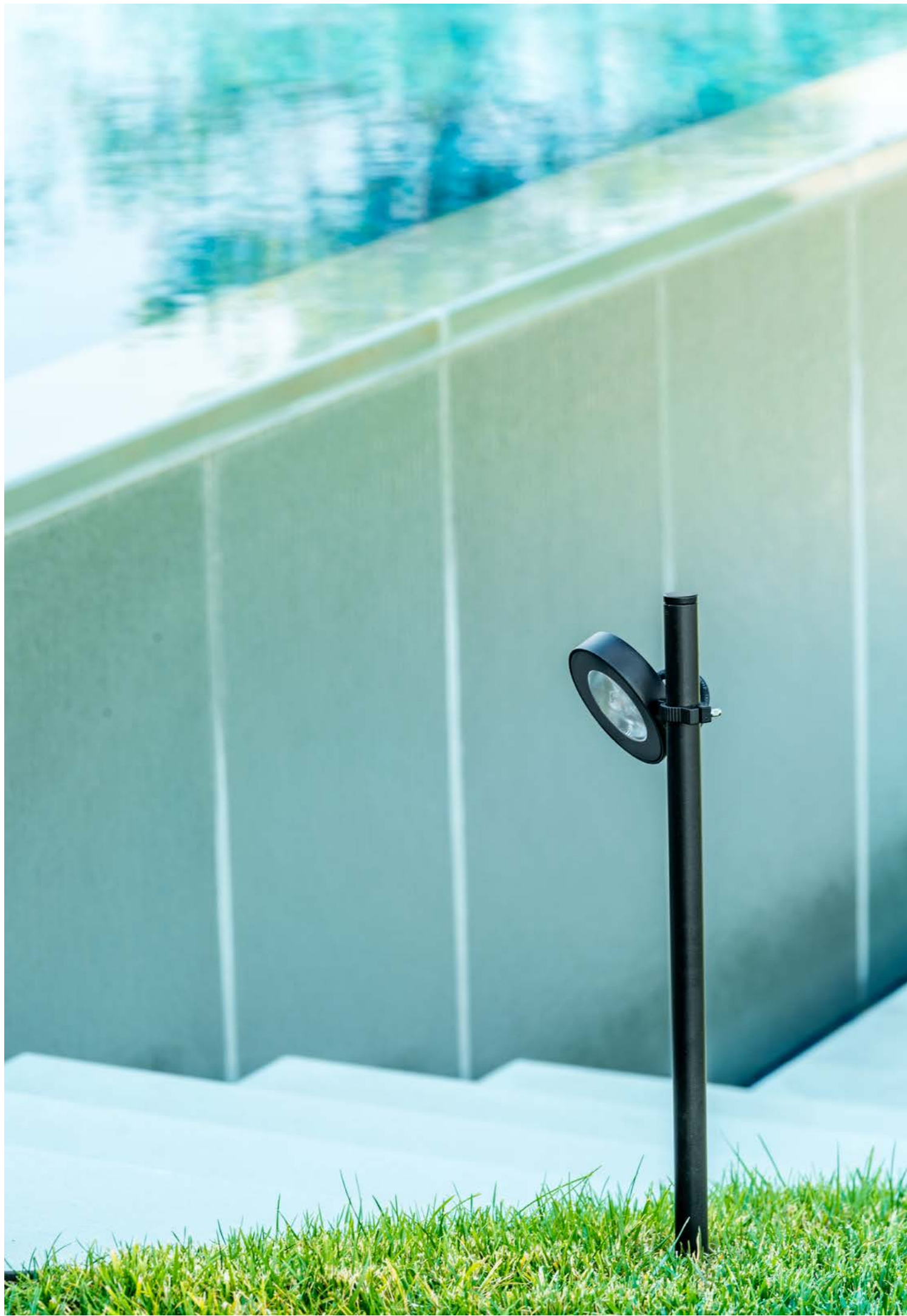

spike

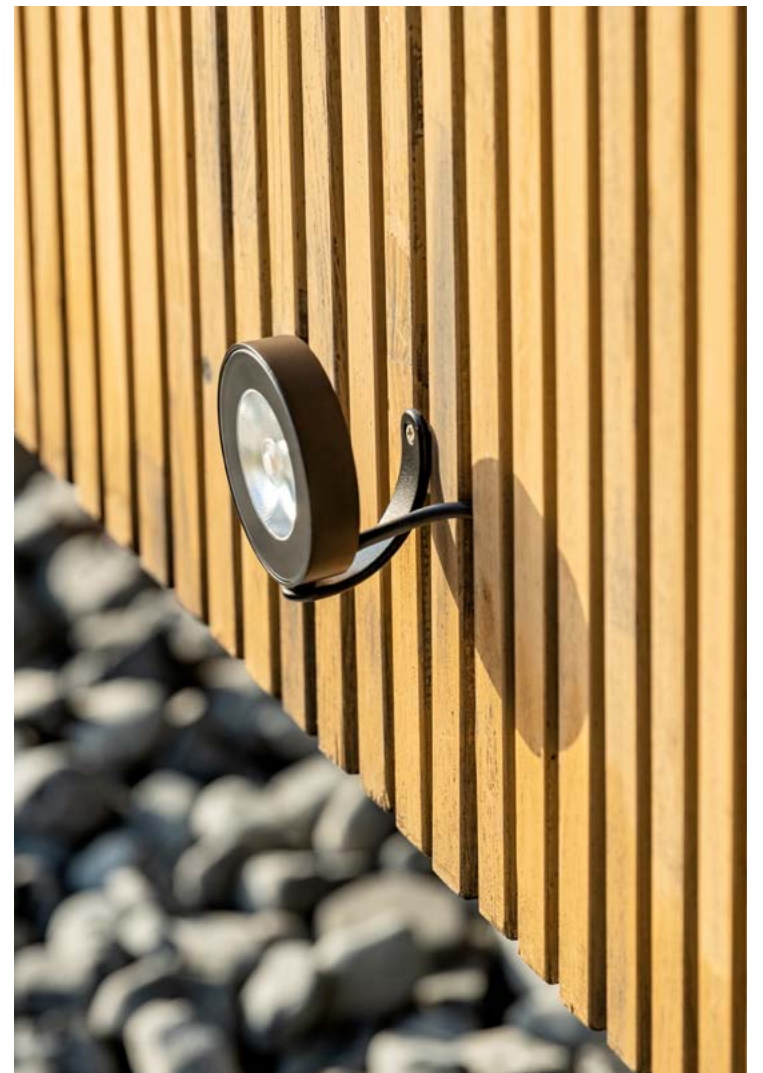

floodlight

Flexibility of composition, freedom of expression, minimalist aesthetic and versatile light beam are the elements that make Frog a modular system, open and always in progress. Suitable both for indoor and outdoor.



applique



floor





# collection

 **bollard** IP66 IK 08

4 mm serigraphed extra-clear glass

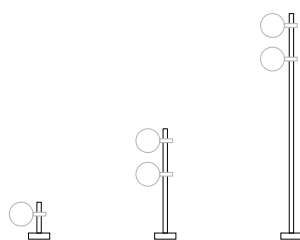
h. 160 mm  
h. 500 mm  
h. 1100 mm



 **downlight** IP66 IK 08

4 mm serigraphed extra-clear glass

h. 160 mm  
h. 500 mm  
h. 1100 mm

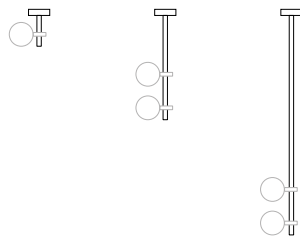

 **applique** IP66 IK 08

4 mm serigraphed extra-clear glass

h. 160 mm  
h. 500 mm

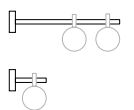

 **spike** IP66 IK 08

4 mm serigraphed extra-clear glass

h. 160 mm  
h. 500 mm  
h. 1100 mm  
h. 2200 mm



 **floor** IP66 IK 08

4 mm serigraphed extra-clear glass

h. 2300 mm



 **floodlight** IP66 IK 08

4 mm serigraphed extra-clear glass

ø 105 mm



FROG collection

DECORATIVE OUTDOOR LIGHTING

# collection

 **applique downlight** IP66 IK 08

 **linear support** 4 mm serigraphed extra-clear glass

h. 1000 mm  
h. 2000 mm

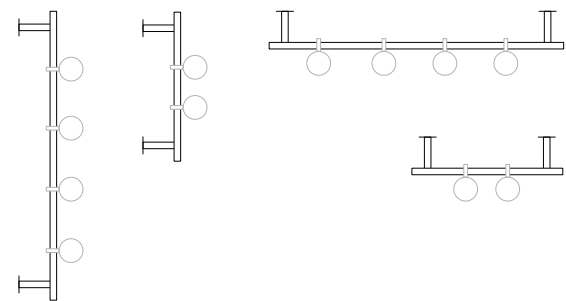

 **applique downlight** IP66 IK 08

 **box** 4 mm serigraphed extra-clear glass

single box  
170 x 170 x h. 100 mm

double box  
365 x 170 x h. 100 mm

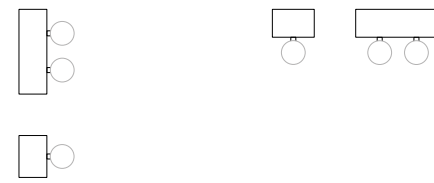







## lighting data

WHITE COB LED

3000K CRI>80  
220-240V 50/60Hz ⚡  
TRIAC dimmable

3 m cable length

2700K / 4000K available on request



	9,6W   655 lm (*) medium		9,6W   595 lm (*) large		9,6W   570 lm (*) wide
	26° beam angle 3090 cd/klm		45° beam angle 1220 cd/klm		102° beam angle 400 cd/klm

(\*) Real Data

## details

Die-cast head made of aluminium alloy with very low copper content. No visible screws. Gore valve to prevent condensing. The product is subjected to galvanic anodizing treatment divided into distinct phases: mechanical satin finishing, surface degreasing, anodic oxidation and finally fixing. Subsequently the product is painted by performing a double pass in-line process, which allows you to generate a single thick protective layer which then generates barrier against atmospheric agents and UV rays. This allows to achieve corrosion resistance performance in salt spray. Pre-treatment with atmospheric pressure plasma is carried out on the surface before gluing of the diffuser on Platek products.

## standard finishes

		
.01 black	.02 white	.09 bronze

FROG collection

DECORATIVE OUTDOOR LIGHTING