

Sistema de iluminación trimless de perfilera de aluminio extruido, específicamente concebido para conseguir efectos cornisa y espacios perimetrales. Permite la instalación de carril trifásico universal para la incorporación de proyectores Deep con adaptador. Óptima iluminación, totalmente invisible desde cualquier ángulo.

Permite múltiples aplicaciones. Fácil instalación. Deep Cove System se fabrica ajustándose al proyecto del cliente. Acabados: Aluminio natural para integrar en el acabado de la arquitectura. Otros acabados, consultar.

Trimless lighting system featuring extruded aluminium profile specifically designed to achieve cornice effects and trimless backlit perimeter spaces, with the capacity to install hidden projectors, or both. It also makes possible the installation of universal three-phase tracks for the incorporation of Deep projectors with an adapter. Optimum lighting, completely invisible from any angle. Features multiple applications. Easy installation. Deep Cove System is custom-made according to the customer's specifications.

**Finishes:** Natural aluminium, for integration into the architecture's finish. Inquire about other finishes.

*Eingelassenes Trimless-Beleuchtungssystem mit Schienen aus extrudiertem Aluminium, speziell entwickelt für Gesimse und eine nahtlose, umlaufende Ausleuchtung von Räumen. Strahler lassen sich verborgen installieren oder mit sichtbaren Strahlern kombinieren. Ermöglicht die Installation einer Universal-Dreiphasenschiene, um Strahler des Modells Deep mit Adapter zu integrieren. Optimale Beleuchtung, die aus jedem Winkel unsichtbar bleibt. Erlaubt diverse Anwendungen. Einfache Installation. Deep Cove System wird nach den Vorgaben des Kunden speziell für sein Projekt angefertigt.*

**Ausführungen:** Aluminium Natur, in die Verkleidungselemente der Architektur zu integrieren. Weitere Ausführungen auf Anfrage.

Fluor. (G5) QR111 máx. 100W (G53)	CDM-R 111 70W (GX8,5) LED AR-111 12W (G53)	LED SMD continuo 24,5W/m 3000K
--------------------------------------	---	--------------------------------

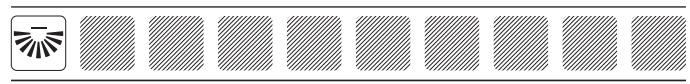
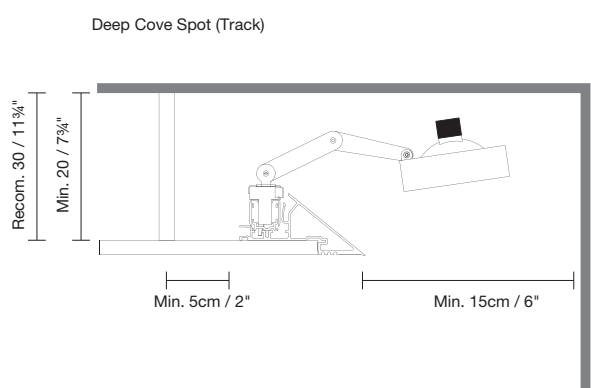
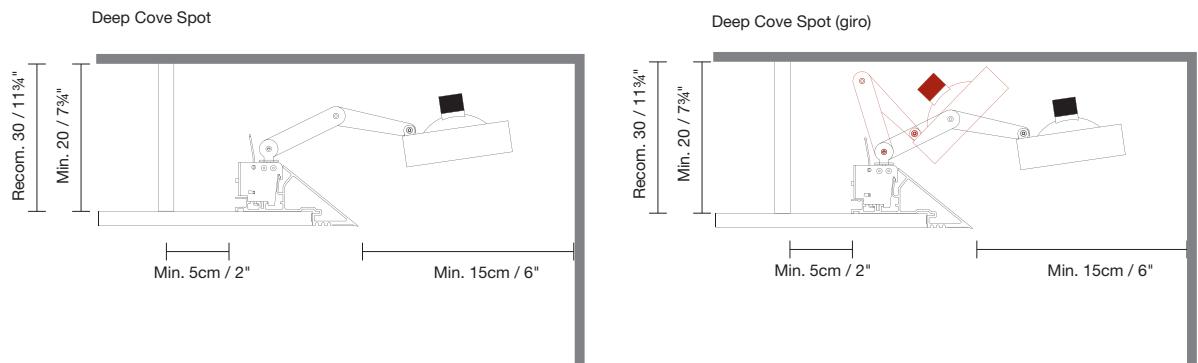
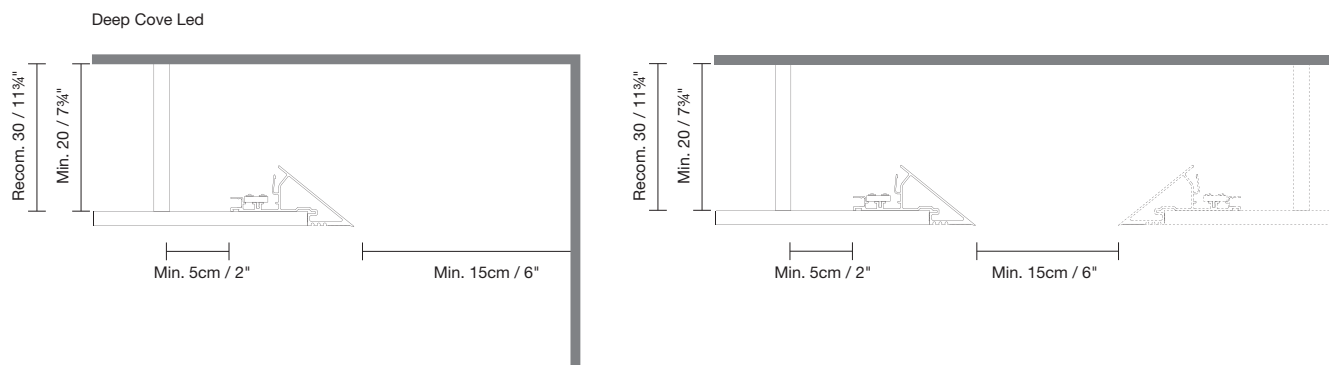
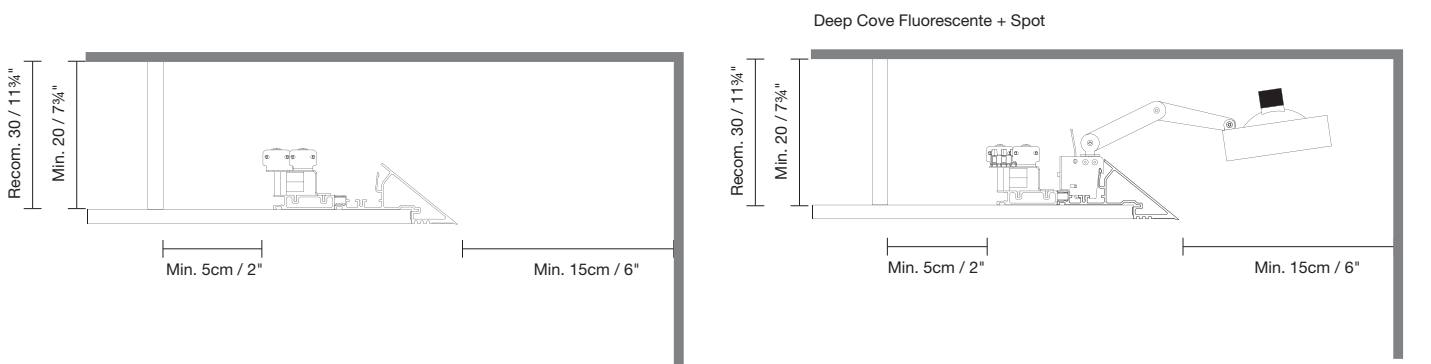

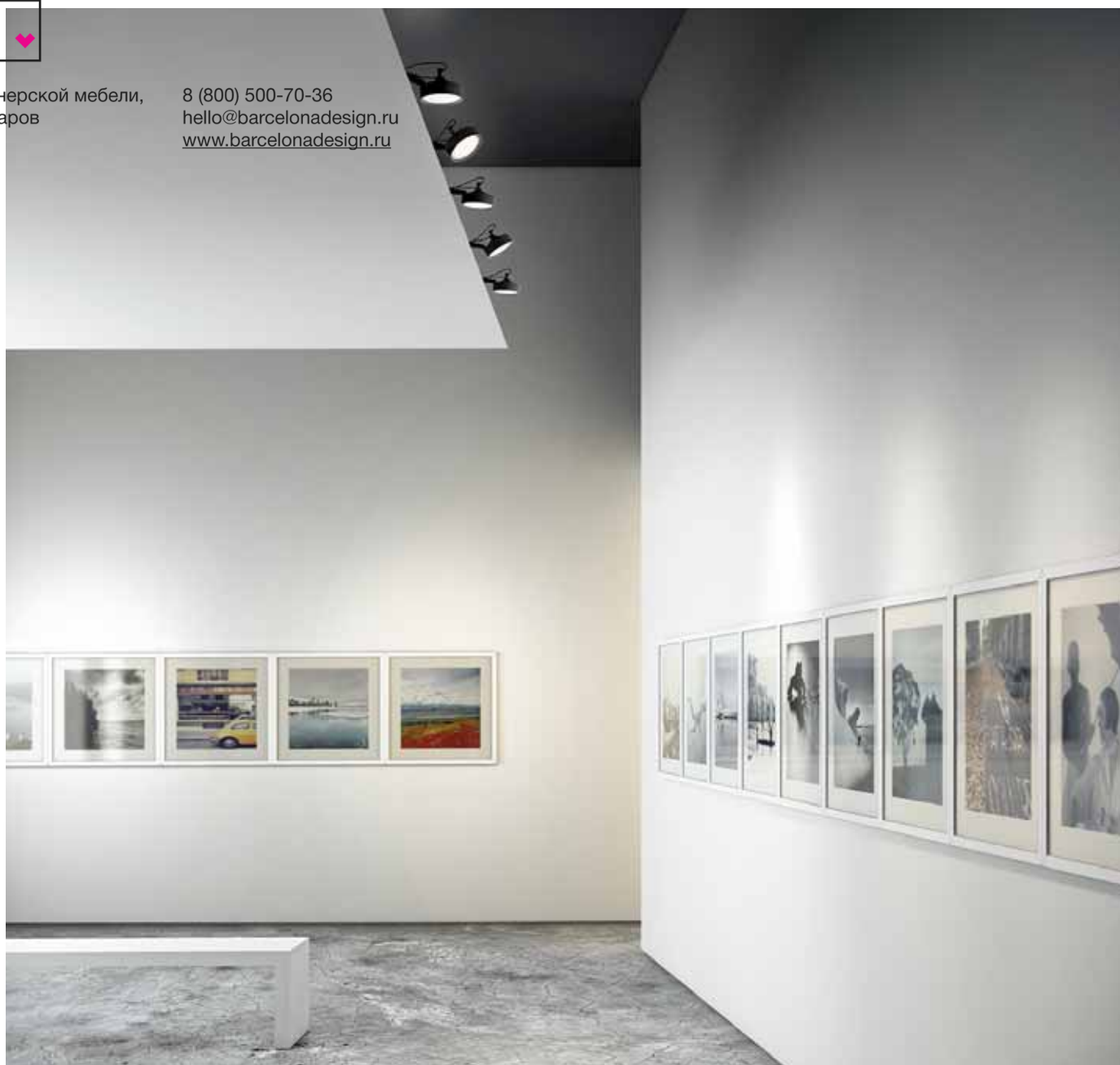

## Deep Cove System

*David Abad*

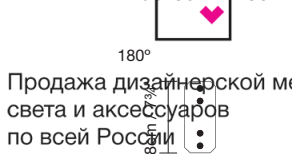

Продажа дизайнерской мебели, света и аксессуаров по всей России

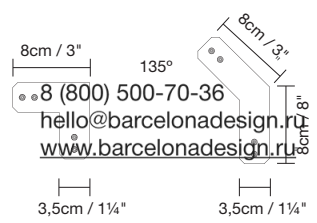

8 (800) 500-70-36  
hello@barcelonadesign.ru  
www.barcelonadesign.ru

**EJEMPLOS**

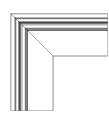

90° angulo interior

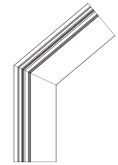

135° angulo interior

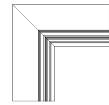

90° angulo exterior

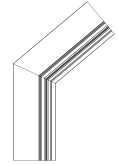

135° angulo exterior

**ACCESORIOS**



Perfil Deep Cove L Máx. 6m



Perfil portacomponentes Deep Cove L Máx. 6m

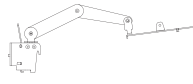

Deep Cove Spot



Deep aro embellecedor QR-111



Deep aro embellecedor + rejilla QR-111



Deep aro embellecedor CDMR-111



Deep aro embellecedor + rejilla CDMR-111

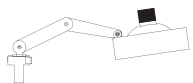

Deep Cove Spot Track



Carril trifasico Global



Carril trifasico Global control DALI



Deep Cove módulo LED



Deep Cove módulo Fluorescente



L

- 2x14/24W L: 70cm / 27 1/2"
- 2x21/39W L: 100cm / 39 1/4"
- 2x28/54W L: 130cm / 51 1/4"
- 2x35/80W L: 160cm / 63"



Indirect light system.



Indirect light system.



Multiple direct light system.



Indirect light system.



Direct light system.



Double light system.



Multiple direct light system.



Indirect light system.



Продажа дизайнерской мебели,  
света и аксессуаров  
по всей России

8 (800) 500-70-36  
hello@barcelonadesign.ru  
[www.barcelonadesign.ru](http://www.barcelonadesign.ru)

