



Underscore® Rectangle

5.5' BubbleMassage™ Bath

K-1173-G

Features

- 122 airjets release thousands of bubbles that surround, support, and massage the body.
- Variable-speed blower lets you adjust massage intensity to 18 levels.
- Zones of Control™ feature allows you to target massage to back, midsection, or feet.
- Lighted keypad.
- Molded lumbar support offers extra comfort while bathing.
- Slotted overflow allows for deep soaking.
- Immediate and manual purge cycles remove residual water from air channels after use.
- End drain.

Material

- Acrylic.

Hydrotherapy

- BubbleMassage.

Installation

- Undermount.
- Drop-in or undermount.

Required Products/Accessories

K-7271 Brass Slotted Overflow Bath Drain

or

K-7272 PVC Slotted Overflow Bath Drain

Recommended Products/Accessories

K-1491 Bath/Whirlpool Pillow

K-1601 Bath/Whirlpool Footstop

K-1705 Whirlpool/BubbleMassage™ Remote Control

K-591 Under-Mount Installation Kit

K-9498 3" Keypad Trim

K-24916 Wireless Music Kit

K-1177 Vinyl Tiling-in Bead

K-23726 Drain treatment

K-23732 Tub & shower cleaner



Codes/Standards

ASME A112.19.7/CSA B45.10

ASTM E162

ASTM E662

KOHLER® Plastic Baths and Receptors

Lifetime Limited Warranty

KOHLER® Hydrotherapy Components





Five-Year Limited Warranty

See website for detailed warranty information.

Available Colors/Finishes

Color tiles intended for reference only.

Color Code Description

	0	White
	NY	Dune
	G9	Sandbar
	K4	Cashmere

1-800-4KOHLER (1-800-456-4537)

Kohler Co. reserves the right to make revisions without notice to product specifications.

For the most current Specification Sheet, go to www.kohler.com.

4-13-2020 06:05 - US/CA

THE BOLD LOOK
OF **KOHLER**®

No change in measurements if connected with drain illustrated. (K-7272)

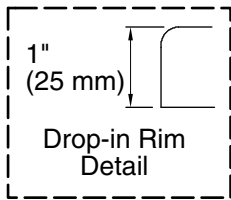

Blower Motor/Control Access
34" (864 mm) W x 15" (381 mm) H Min

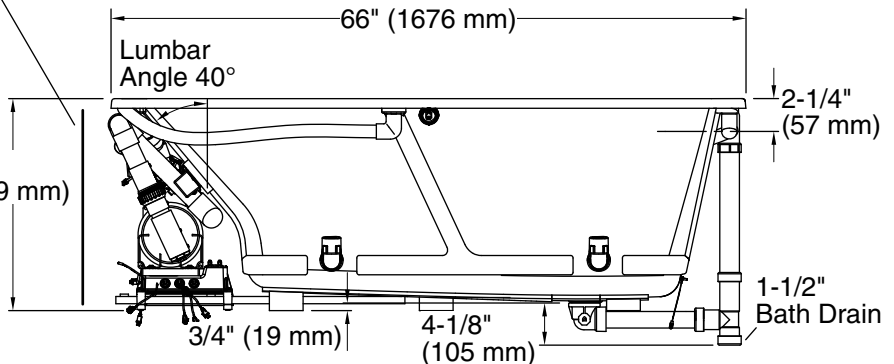
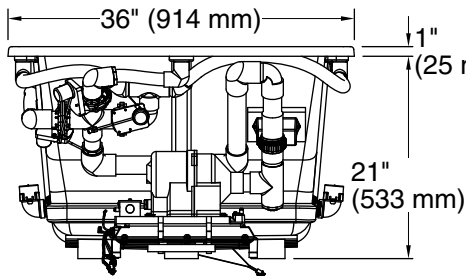
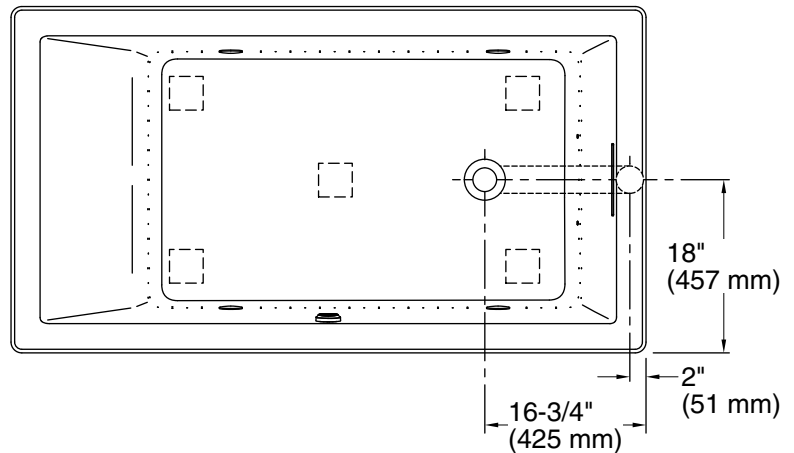

Required Electrical Service

One dedicated circuit required, protected with Class A Ground-Fault Circuit-Interrupter (GFCI). Outside North America, this device may be known as a Residual Current Device (RCD).

Blower: 240 V, 15 A, 50/60 Hz

Technical Information

All product dimensions are nominal.

Installation:	Drop-in, Under-mount
Drain location:	End
Basin area, bottom:	44-1/2" x 26-1/2" (1130 mm x 673 mm)
Basin area, top:	60-1/4" x 30-1/4" (1530 mm x 768 mm)
Weight:	105 lbs (47.6 kg)
Minimum floor load:	60 lbs/ft ² (292.9 kg/m ²)
Water depth:	17-3/4" (451 mm)
Water capacity:	102 gal (386.1 L)
Cutout:	Drop-in, 65" x 35" (1651 mm x 889 mm)
Electrical component rating:	Blower: 240 V, 5 A, 50/60 Hz
Blower speed:	Variable
Minimum flat for door:	2-7/16" (61 mm)

Notes

Measure your actual product for rough-in details. Install this product according to the installation instructions.

The hot water supply should be 70% of the capacity of the bath or greater. Installations will vary.

Kit is required for under-mount installations (sold separately).

If relocating the blower motor, do not relocate or alter the PVC tee or coiled flexible tubing connected to the blower. Follow the blower relocation instructions exactly. Provide access for servicing the blower.