

ESSENTIAL

Studio expormim

Sillón comedor “Chicago” / dining armchair

C707

OUT



Colección fabricada en tubo de aluminio de alta resistencia y tejida a mano artesanalmente con fibra sintética plana (anchura 6 mm) de polietileno de alta densidad (HDPE). Posibilidad de realizar una gran variedad de composiciones de asientos debido a la modularidad de sus elementos. Las patas de los módulos se encuentran fabricadas en acero inoxidable satinado. Las mesas de centro se sirven con un sobre oculto de Policarbonato (PC) para garantizar una mayor solidez en la tapa.

Collection made of high resistance aluminum tube and hand-woven flat synthetic fiber made of high density polyethylene (HDPE), 0.24" wide. Possibility of creating a wide variety of layouts due to the modularity of its elements. Legs made of satin stainless steel. A hidden shell of polycarbonate (PC) reinforces the top of the coffee tables.

Medidas / Dimensions	55 x 62 x 82 cm 21.75" x 24.5" x 32.25"
Peso / Weight	4 kg / 8.8 lb
Volumen / Volume	0,28 m ³ / 9.89 ft ³

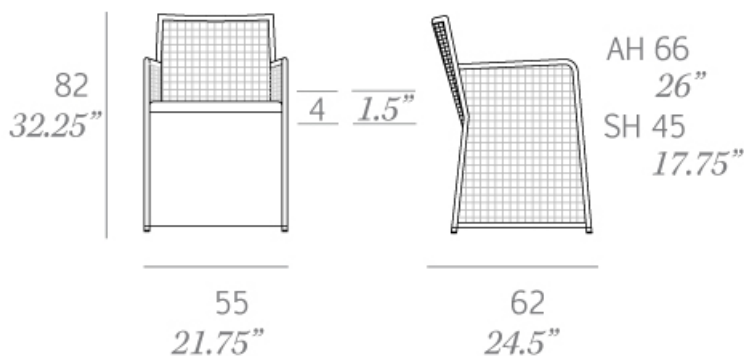

HDPE - Fibras sintéticas / synthetic fibres

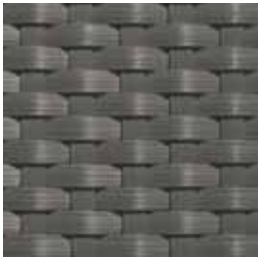

022 solid grey

Serie 2 - Confección / cushions

Duo Outdoor



Duo 54

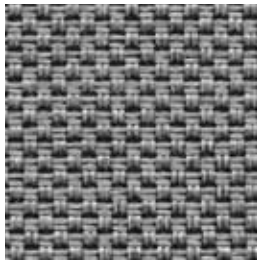

Duo 51



Duo 14

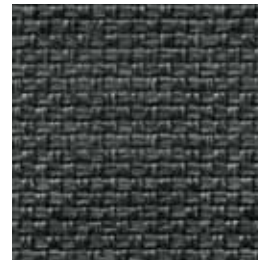

Duo 53



Duo 55



Duo 01

Serie 4 - Confección / cushions

Silvertex™



Silvertex Ice



Silvertex Taupe



Silvertex Meteor



Silvertex Carbon

Zander®



Zander Pure White



Zander Auster

Serie 1 - Confección / cushions

Tempotest®



Marine C



Marine BG



Marine GC

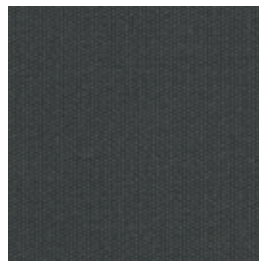

Marine G



Marine GN



Marine M

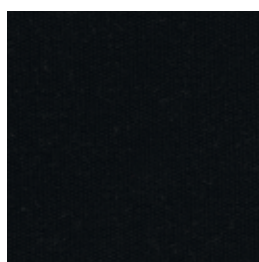

Marine NE



Marine MO



Marine A



Marine VN

Serie 2 - Confección / cushions

Tempotest®



Marivent 23



Marivent 40



Marivent 42



Marivent 44



Marivent 24



Marivent 41



Marivent 43

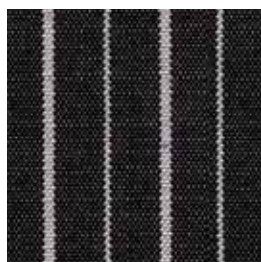

Marivent 45