

### Features

- 60"L x 32"W x 18-1/4"H.
- The only two-person bath that fits into a standard 5' alcove.
- Constructed of KOHLER® Cast Iron.
- Designed for two-person bathing.

### Installation

- Drop-in, under-mount, or alcove.

### Required Products/Accessories

K-7169-AF 1-1/2" Contoured Pop-up Drain

### Recommended Products/Accessories

K-586 Under-Mount Installation Kit  
 K-1172 Adjustable feet  
 K-1179 Vinyl Tiling-in Bead  
 K-1491 Bath/Whirlpool Pillow  
 K-1601 Bath/Whirlpool Footstop  
 K-702200-G54 Frameless Sliding Bath Door  
 K-702200-G73 Frameless Sliding Bath Door  
 K-702200-L Frameless Sliding Bath Door  
 K-702205-L Frameless Sliding Bath Door  
 K-706000-D3 Frameless Sliding Bath Door  
 K-706000-L Frameless Sliding Bath Door  
 K-706003-L Frameless Sliding Bath Door  
 K-706004-D3 Frameless Sliding Bath Door  
 K-706004-L Frameless Sliding Bath Door  
 K-706007-L Frameless Sliding Bath Door  
 K-23726 Drain treatment  
 K-23725 Cast iron cleaner



ADA

### Codes/Standards













ASME A112.19.1/CSA B45.2  
 ASTM F462  
 ADA  
 ICC/ANSI A117.1

### KOHLER® Enameled Cast Iron Bath and Shower Base Lifetime Limited Warranty

See website for detailed warranty information.

### Available Colors/Finishes

*Color tiles intended for reference only.*

Color	Code	Description
	0	White
	96	Biscuit
	47	Almond
	NY	Dune
	95	Ice™ Grey
	G9	Sandbar
	33	Mexican Sand™
	K4	Cashmere
	58	Thunder™ Grey
	7	Black Black™
	GRL	Grey Lavender
	DGB	Indigo Blue
	PLM	Black Plum

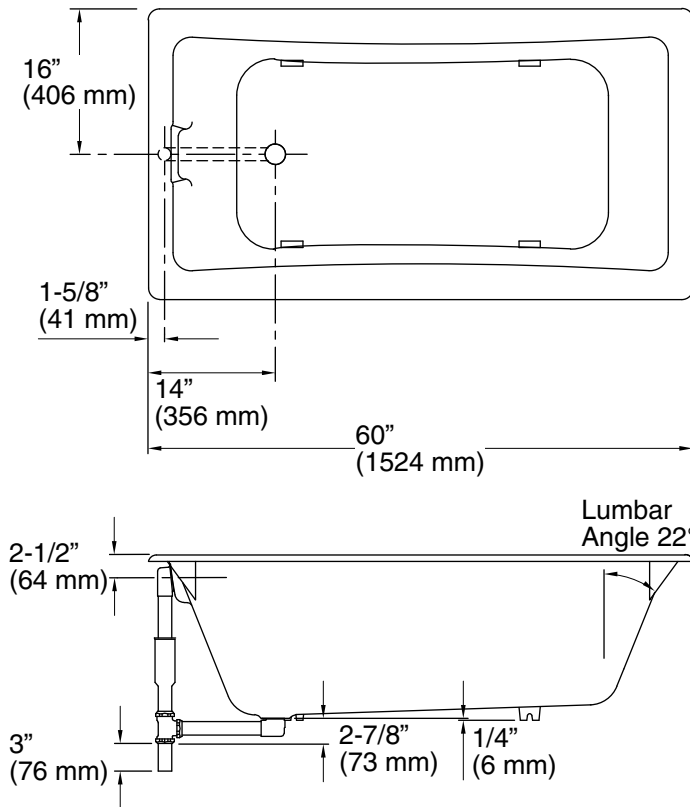

No change in measurements if connected with drain illustrated. (K-7169-AF)

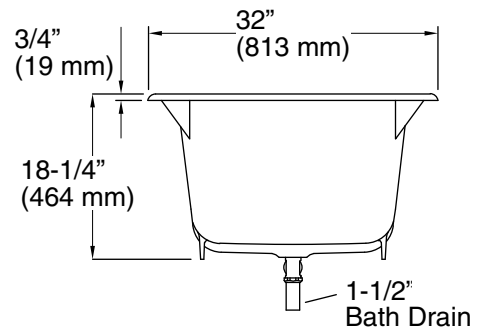

### Technical Information

All product dimensions are nominal.

Installation:	Drop-in, Under-mount, Three-wall alcove
Drain location:	End
Basin area, bottom:	40-1/2" x 20" (1029 mm x 508 mm)
Basin area, top:	52-3/4" x 24" (1340 mm x 610 mm)
Weight:	250 lbs (113.4 kg)
Minimum floor load:	58 lbs/ft <sup>2</sup> (283.2 kg/m <sup>2</sup> )
Water depth:	13-5/8" (346 mm)
Water capacity:	60 gal (227.1 L)
Cutout:	Drop-in, 58-1/2" x 30-1/2" (1486 mm x 775 mm)
Template:	Under-mount, K-586, required, not included
Minimum flat for door:	2-1/4" (57 mm)

### Notes

Measure your actual product for rough-in details. Install this product according to the installation instructions.

The hot water supply should be 70% of the capacity of the bath or greater. Installations will vary.

Kit is required for under-mount installations (sold separately).

ADA compliant when installed to the specific requirements of these regulations.