

Features

- Molded lumbar support offers extra comfort while bathing.
- Slotted overflow allows for deep soaking.
- Integral flange helps prevent water from seeping behind wall and simplifies alcove installation.

Material

- Acrylic.
- Acrylic.

Installation

- Right drain.
- Requires K-7271 or K-7272 Clearflo slotted overflow bath drain (sold separately).
- Alcove.

Required Products/Accessories

K-7271 Brass Slotted Overflow Bath Drain

or

K-7272 PVC Slotted Overflow Bath Drain

Recommended Products/Accessories

K-1491 Bath/Whirlpool Pillow

K-1601 Bath/Whirlpool Footstop

K-24916 Wireless Music Kit

K-702200-G54 Frameless Sliding Bath Door

K-702200-G73 Frameless Sliding Bath Door

K-702200-L Frameless Sliding Bath Door

K-702205-L Frameless Sliding Bath Door

K-23726 Drain treatment

K-23732 Tub & shower cleaner



ADA

Codes/Standards

CSA B45.5/IAPMO Z124

ASTM E162

ASTM E662

ADA









ICC/ANSI A117.1

KOHLER® Plastic Baths and Receptors Lifetime Limited Warranty

See website for detailed warranty information.

Available Colors/Finishes

Color tiles intended for reference only.

Color	Code	Description
	0	White
	96	Biscuit
	47	Almond
	NY	Dune
	95	Ice™ Grey
	G9	Sandbar
	K4	Cashmere
	58	Thunder™ Grey
	7	Black Black™

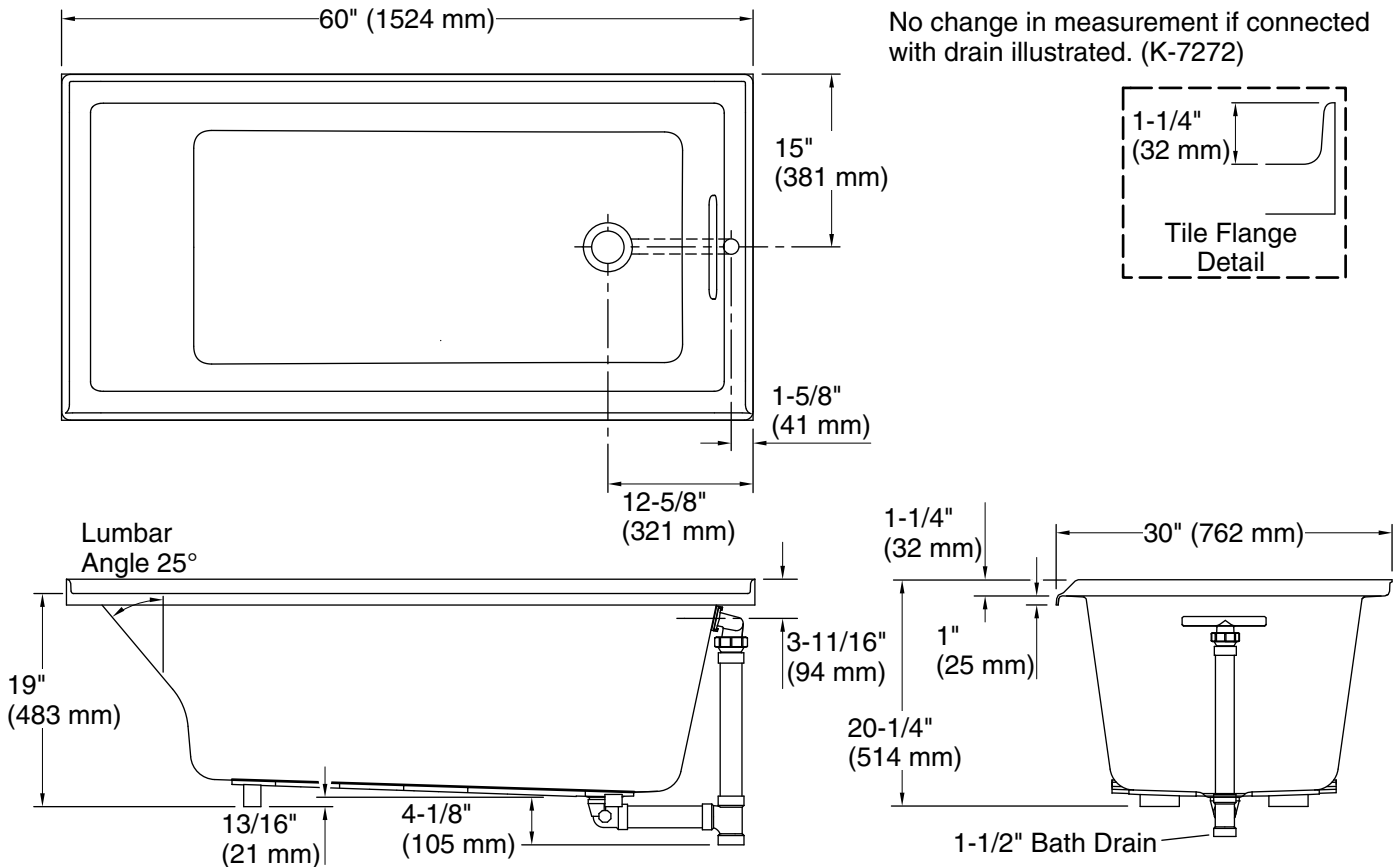

No change in measurement if connected with drain illustrated. (K-7272)

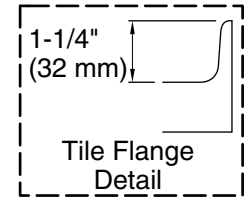

Technical Information

All product dimensions are nominal.

Installation:	Three-wall alcove
Drain location:	Right
Basin area, bottom:	42-7/16" x 20" (1078 mm x 508 mm)
Basin area, top:	54-5/16" x 24-1/4" (1380 mm x 616 mm)
Weight:	75 lbs (34 kg)
Minimum floor load:	42 lbs/ft ² (205.1 kg/m ²)
Water depth:	1-5/8" (384 mm)
Water capacity:	59.8 gal (226.4 L)
Minimum flat for door:	1-15/16" (50 mm)

Notes

- Measure your actual product for rough-in details. Install this product according to the installation instructions.
- The hot water supply should be 70% of the capacity of the bath or greater. Installations will vary.
- ADA compliant when installed to the specific requirements of these regulations.