

Features

- Comfort Depth® design offers a convenient 19" step-over height while retaining the same depth as a standard 21" bath.
- Generous 6-foot length provides an incredibly spacious bathing area.
- Molded lumbar support offers extra comfort while bathing.
- Slotted overflow allows for deep soaking.
- Integral apron.
- Integral flange helps prevent water from seeping behind wall and simplifies alcove installation.
- Textured bottom surface.
- Coordinates with other products in the Archer collection.

Material

- Acrylic.

Installation

- Left drain.
- Alcove.

Required Products/Accessories

K-7271 Brass Slotted Overflow Bath Drain

or

K-7272 PVC Slotted Overflow Bath Drain

Recommended Products/Accessories

K-9529 Removable Bath Seat

K-23726 Drain treatment

K-23732 Tub & shower cleaner



ADA

Codes/Standards

CSA B45.5/IAPMO Z124

ASTM E162

ASTM E662

ADA









ICC/ANSI A117.1

KOHLER® Plastic Baths and Receptors Lifetime Limited Warranty

See website for detailed warranty information.

Available Colors/Finishes

Color tiles intended for reference only.

| Color | Code | Description |
|--|------|---------------|
|  | 0 | White |
|  | 96 | Biscuit |
|  | 47 | Almond |
|  | NY | Dune |
|  | 95 | Ice™ Grey |
|  | G9 | Sandbar |
|  | K4 | Cashmere |
|  | 58 | Thunder™ Grey |
|  | 7 | Black Black™ |

No change in measurements if connected with drain illustrated. (K-7272)

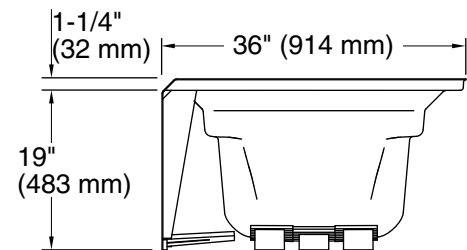
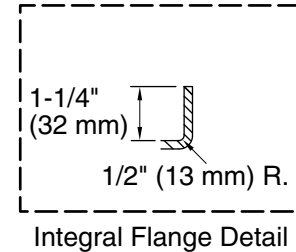
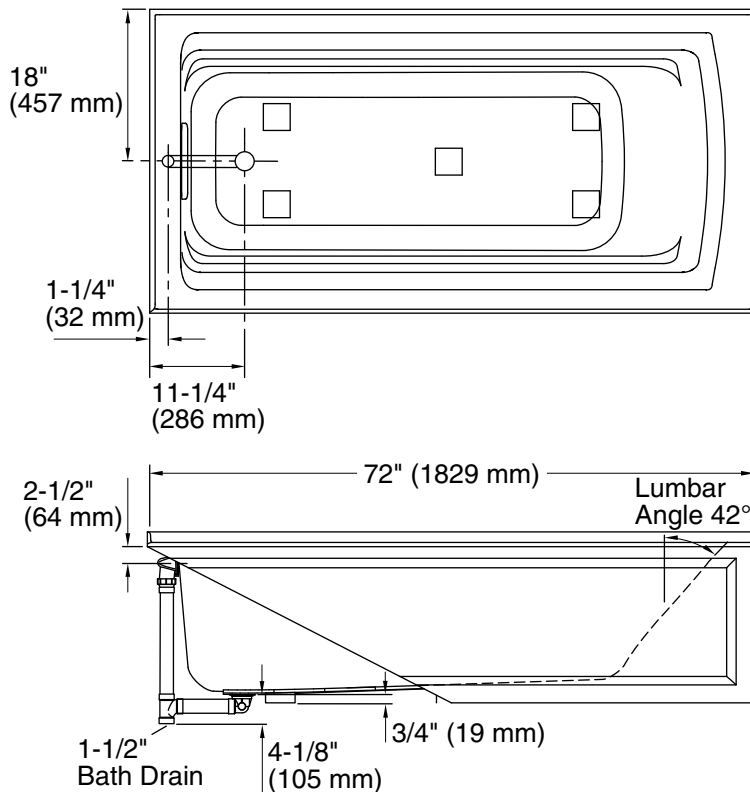

Technical Information

All product dimensions are nominal.

| | |
|------------------------|---|
| Installation: | Three-wall alcove |
| Drain location: | Left |
| Basin area, bottom: | 51-3/8" x 21" (1305 mm x 533 mm) |
| Basin area, top: | 64-1/2" x 30-1/2" (1638 mm x 775 mm) |
| Weight: | 80 lbs (36.3 kg) |
| Minimum floor load: | 40 lbs/ft ² (195.3 kg/m ²) |
| Water depth: | 15" (381 mm) |
| Water capacity: | 72 gal (272.5 L) |
| Minimum flat for door: | 1-9/16" (40 mm) |

Notes

- Measure your actual product for rough-in details. Install this product according to the installation instructions.
- The hot water supply should be 70% of the capacity of the bath or greater. Installations will vary.
- ADA compliant when installed to the specific requirements of these regulations.