

EAN CODE: 3276000596295
3276000632436
3276000596738

FR Manuel d'Instructions

ES Manual de Instrucciones

PT Manual de Instruções

IT Manuale di Istruzioni

EL Εγχειρίδιο Οδηγιών

PL Instrukcja Obsługi

RU Руководства по
Эксплуатации

KZ Пайдаланушы Нұсқаулығы

UA Інструкція з Експлуатації

RO Manual de Instrucțiuni

BR Manual de Instruções

EN Instructions Manual

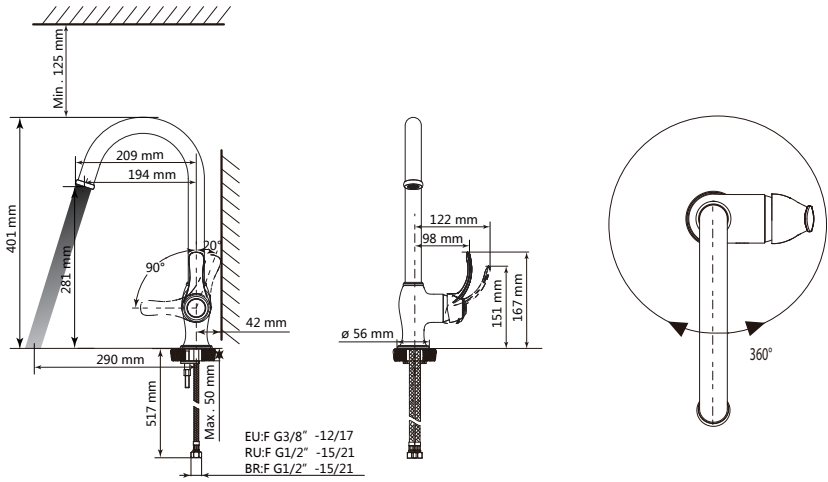

B

A

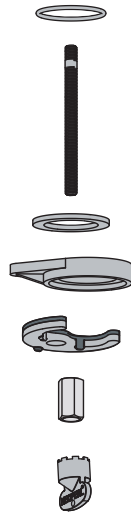
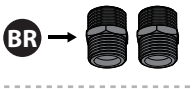
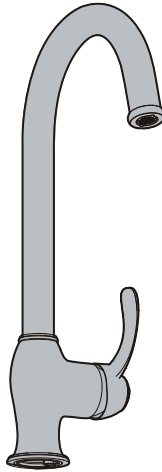

C

D

E

F

G

H

J

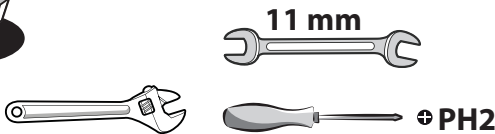



FR: Préparation / **ES:** Preparación / **PT:** Preparação / **IT:** Preparazione / **EL:** Προετοιμασία /
PL: Przygotowanie / **RU:** Подготовка / **KZ:** Дайындау / **UA:** Підготування / **RO:** Pregătire / **BR:** Preparação /
EN: Preparation



4



FR: Montage / **ES:** Montaje / **PT:** Montagem / **IT:** Montaggio / **EL:** Συναρμολόγηση /
PL: Montaż / **RU:** Сборка / **KZ:** Монтаждау / **UA:** Збірка / **RO:** Montaj / **BR:** Montagem /
EN: Assembly



5 → 7



FR: Utilisation eau chaude-eau froide/ **ES:** Utilización agua caliente-agua fría/ **PT:** Utilização água quente-água fria/
IT: Uso acqua calda-acqua fredda/ **EL:** Χρήση ζεστού-κρύου νερού/ **PL:** Użytkowanie zimnej wody-gorącej wody/
RU: Використання гарячої води/ **KZ:** Суық және ыстық суды қолдану/ **UA:** води - холодної води/
RO: Utilizare apă caldă-apă rece/ **BR:** Uso de água quente e fria/ **EN:** Using hot and cold water



8

FR: Changement de cartouche/ **ES:** Cambio de cartucho/ **IT:** Cambio cartuccia/ **PT:** Mudança de cartucho/
EL: Αλλαγή φυσιγγίου/ **PL:** Wymiana wkładu / **RU:** Смена картриджа/ **KZ:** Картриджді ауыстыру/
UA: Заміна картриджа/ **RO:** Schimbare cartuş/ **BR:** Substituição de cartucho/ **EN:** Replacing the cartridge



9 → 12

FR: Changement de mousseur/ **ES:** Cambio de aireador/ **PT:** Mudança de arejador/ **IT:** Cambio rompigetto/
EL: Αλλαγή αεράτορα / **PL:** Wymiana perlatora / **RU:** Смена аэратора/ **KZ:** Ауақанықтырғышты ауыстыру/
UA: Заміна аератора/ **RO:** Schimbare aerator/ **BR:** Substituição do aerador/ **EN:** Replacing the aerator



13

FR: Changement de flexibles/ **ES:** Cambio de flexibles / **PT:** Mudança de flexíveis/ **IT:** Cambio flessibili/
EL: Αλλαγή λάστιχων/ **PL:** Wymiana wężyków instalacyjnych / **RU:** Смена гибкого шланга для смесителя/
UA: Заміна гнучкого шланга для змішувача/ **KZ:** Қоспалауышқа арналған иілгіш шлангты ауыстыру/
RO: Schimbare furtune flexibile/ **BR:** Substituição das mangueiras/ **EN:** Replacing the hoses



14 → 15



FR: Préparation / ES: Preparación / PT: Preparação / IT: Preparazione / EL: Προετοιμασία /
PL: Przygotowanie / RU: Подготовка / KZ: Дайындау / UA: Підготування / RO: Pregătire /
BR: Preparação / EN: Preparation

1

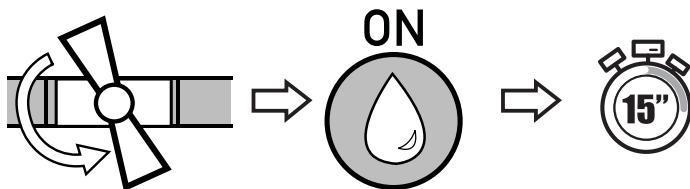

2

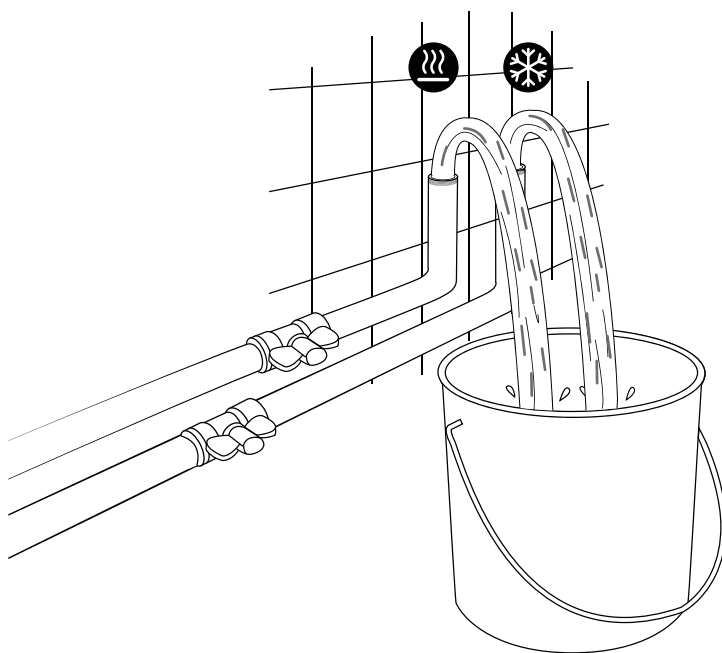

3

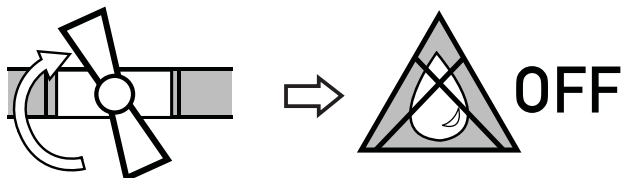



FR: Montage / ES: Montaje / PT: Montagem / IT: Montaggio / EL: Συναρμολόγηση /
PL: Montaż / RU: Сборка / KZ: Монтаж/дау / UA: Збірка / RO: Montaj / BR: Montagem /
EN: Assembly

1

1

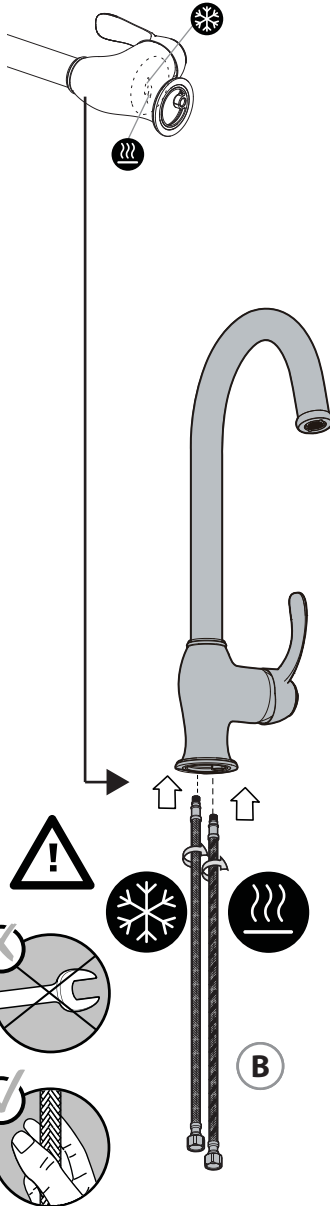

2

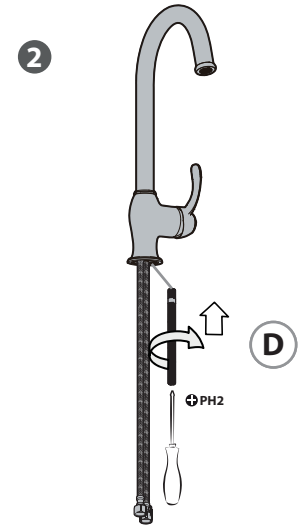

3

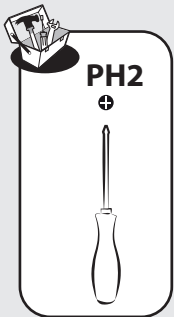
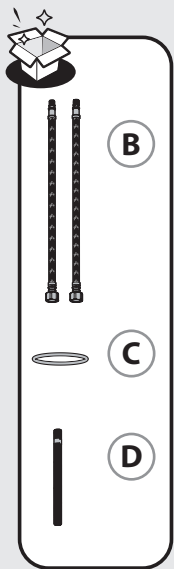
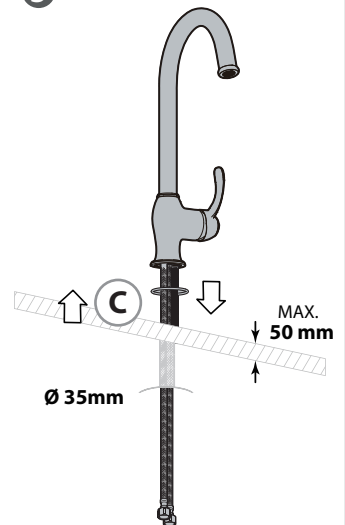

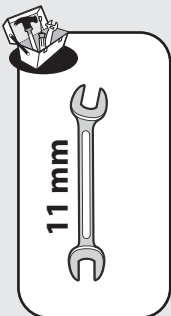
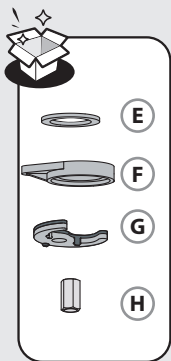

2

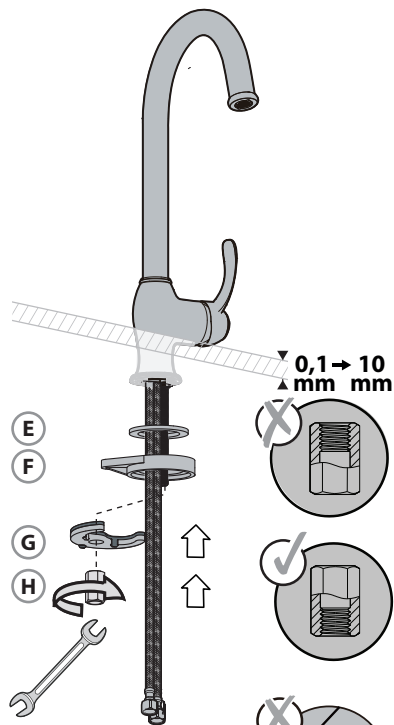
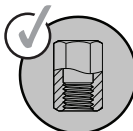
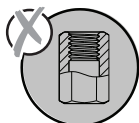
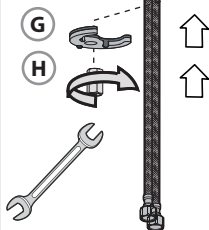
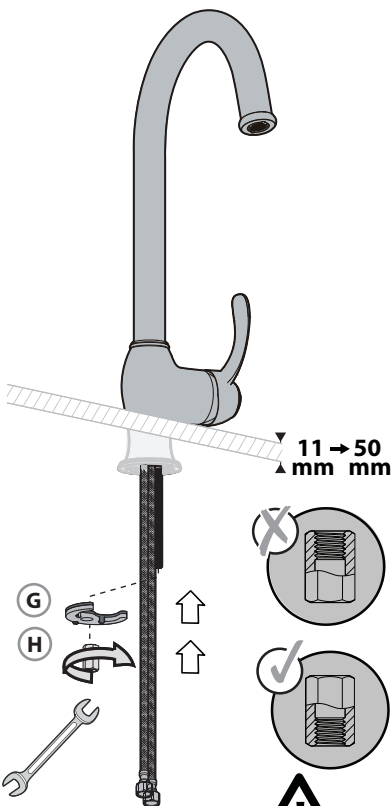
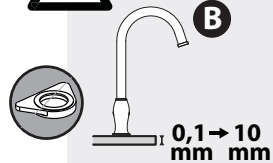
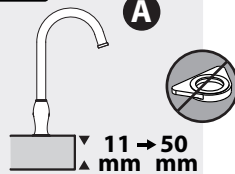

E
F

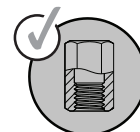

G
H

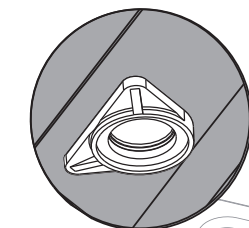
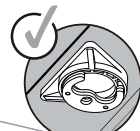

F

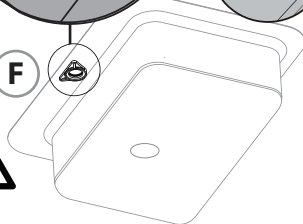

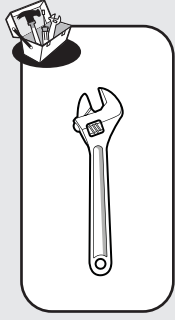

3

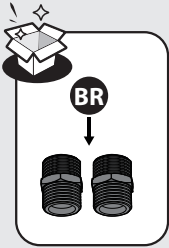
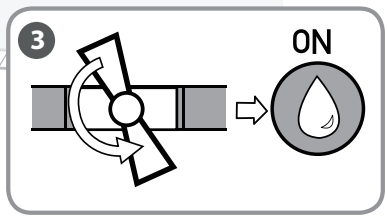
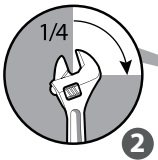
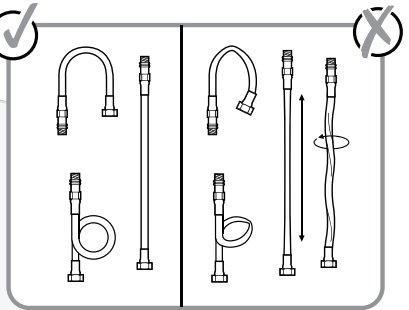
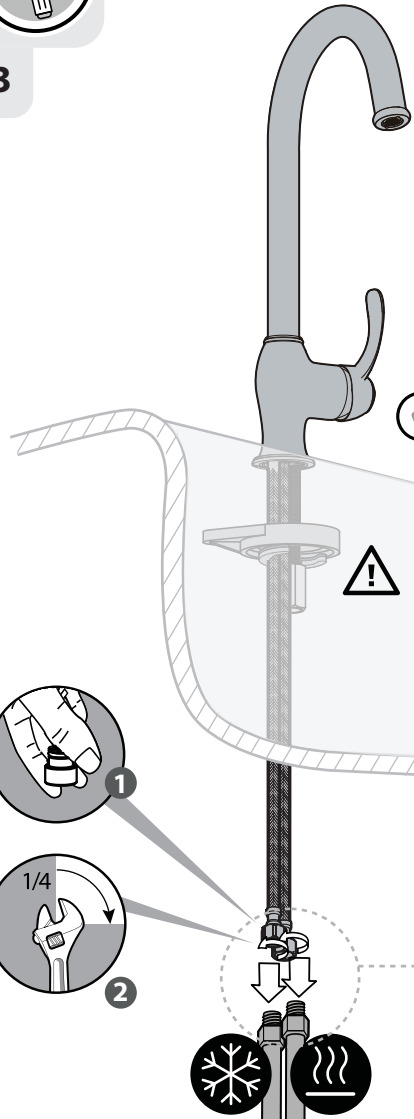

! + BR

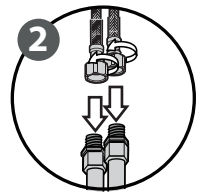
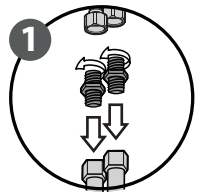
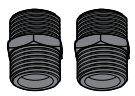



FR: Utilisation eau chaude-eau froide/ **ES:** Utilización agua caliente-agua fría/ **PT:** Utilização água quente-água fria/
IT: Uso acqua calda-acqua fredda/ **EL:** Χρήση ζεστού-κρύου νερού/ **PL:** Użytkowanie zimnej wody-gorącej wody/
RU: Використання гарячої води/ **KZ:** Суық және ыстық суды қолдану/ **UA:** води - холодної води/
RO: Utilizare apă caldă-apă rece/ **BR:** Uso de água quente e fria/ **EN:** Using hot and cold water

1

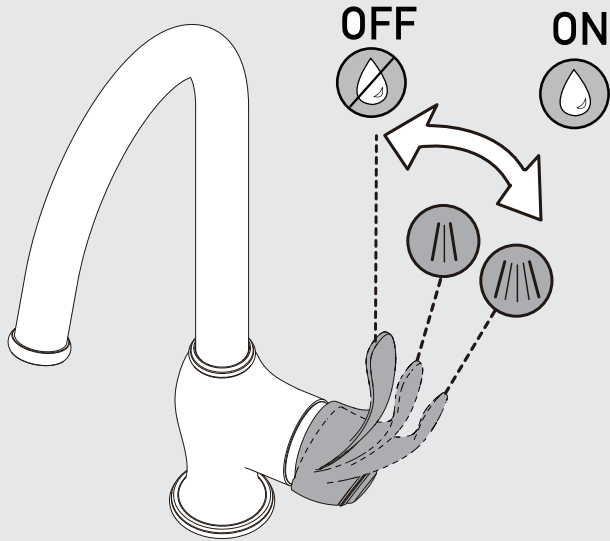
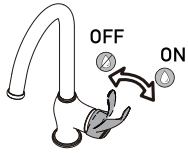

2

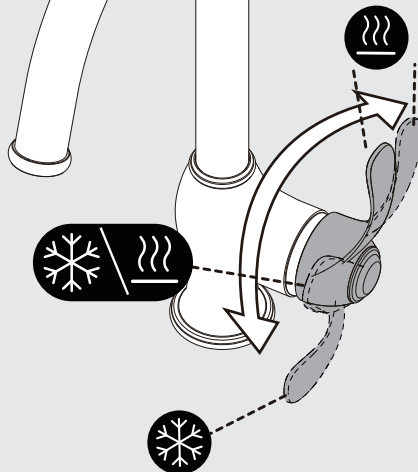

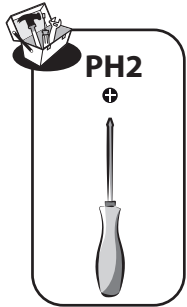

FR: Changement de cartouche/ ES: Cambio de cartucho/ IT: Cambio cartuccia/ PT: Mudança de cartucho/
EL: Αλλαγή φυσιγγίου/ PL: Wymiana wkładu / RU: Смена картриджа/ KZ: Картриджді ауыстыру/
UA: Заміна картриджа/ RO: Schimbare cartuş / BR: Substituição de cartucho/ EN: Replacing the cartridge

1

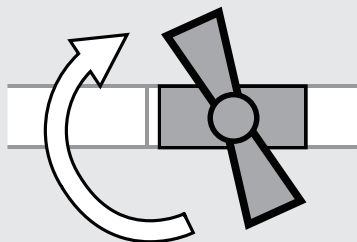

2

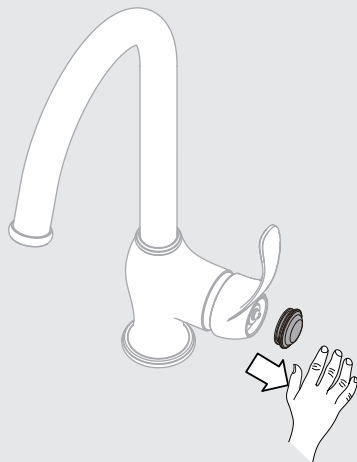

3

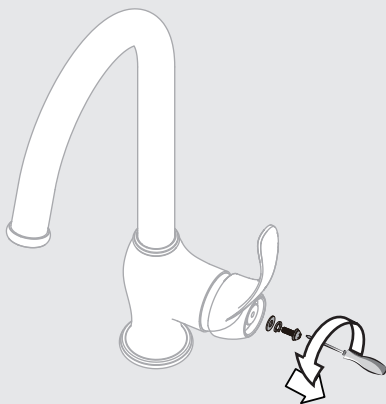

4

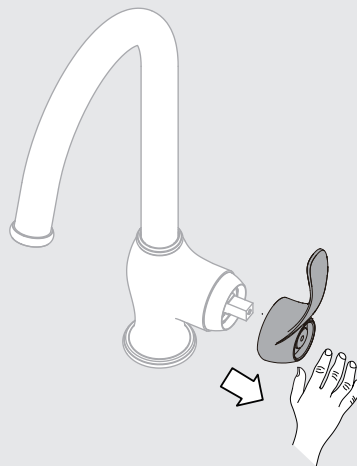

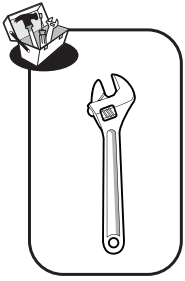

FR: Changement de cartouche/ **ES:** Cambio de cartucho/ **IT:** Cambio cartuccia/ **PT:** Mudança de cartucho/
EL: Αλλαγή φουσιγγίου/ **PL:** Wymiana wkładu / **RU:** Смена картриджа/ **KZ:** Картриджді ауыстыру/
UA: Заміна картриджа/ **RO:** Schimbare cartuş/ **BR:** Substituição de cartucho/ **EN:** Replacing the cartridge

5

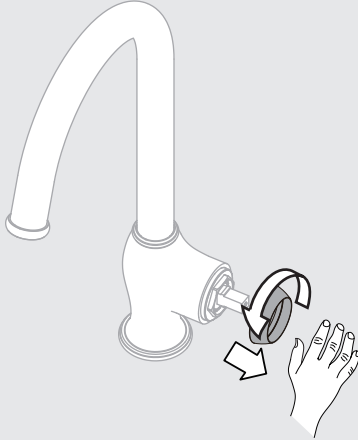

6

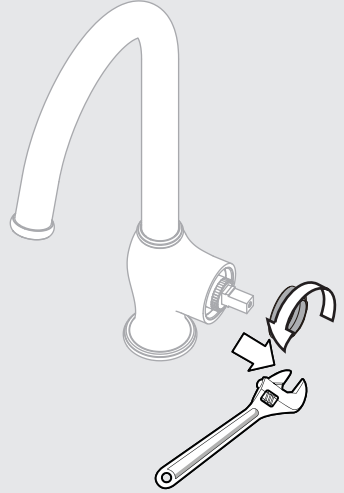

7



8

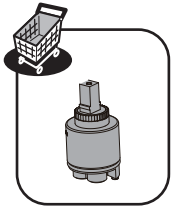
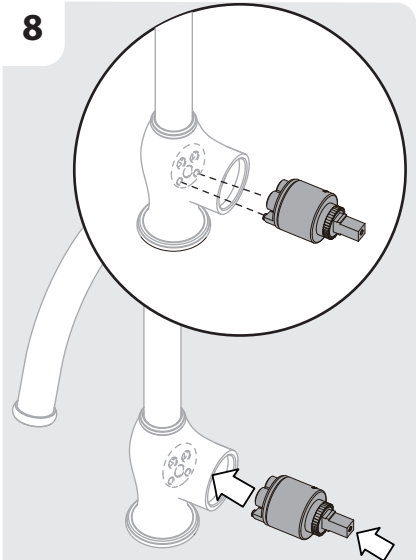

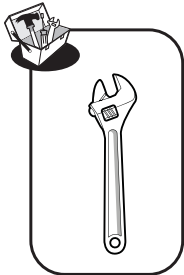

FR: Changement de cartouche/ ES: Cambio de cartucho/ IT: Cambio cartuccia/ PT: Mudança de cartucho/
EL: Αλλαγή φουσιγγίου/ PL: Wymiana wkładu / RU: Смена картриджа/ KZ: Картриджді ауыстыру/
UA: Заміна картриджа/ RO: Schimbare cartus/ BR: Substituição de cartucho/ EN: Replacing the cartridge

9

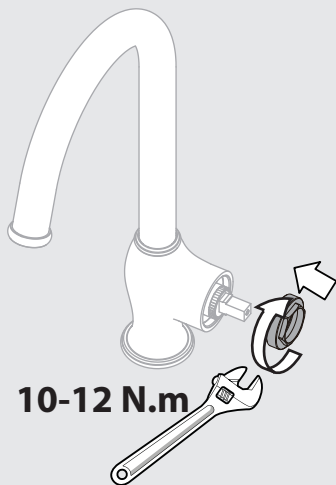

10

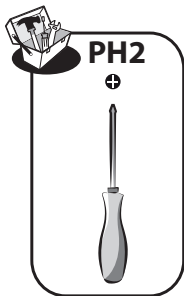
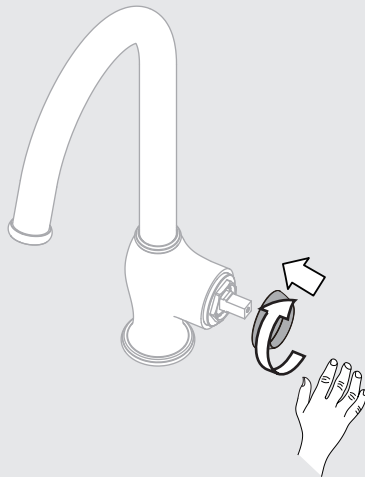

11

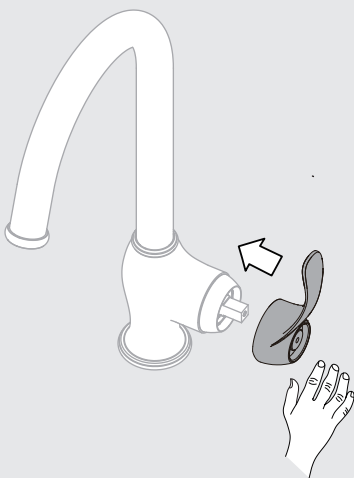

12

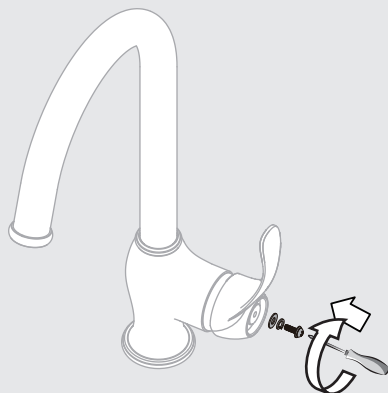



FR: Changement de cartouche/ **ES:** Cambio de cartucho/ **IT:** Cambio cartuccia/ **PT:** Mudança de cartucho/
EL: Αλλαγή φιασιγγίου/ **PL:** Wymiana wkładu / **RU:** Смена картриджа/ **KZ:** Картриджді ауыстыру/
UA: Заміна картриджа/ **RO:** Schimbare cartuş/ **BR:** Substituição de cartucho/ **EN:** Replacing the cartridge

13

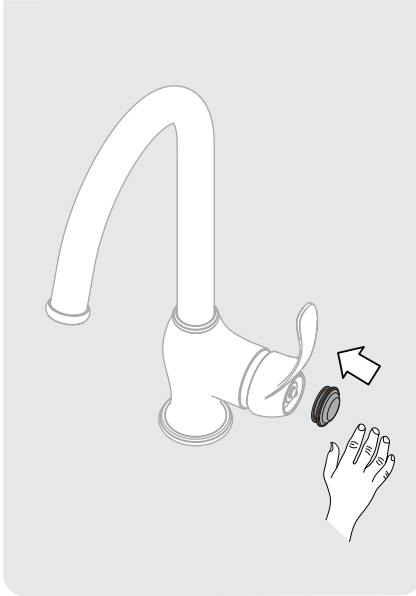

14

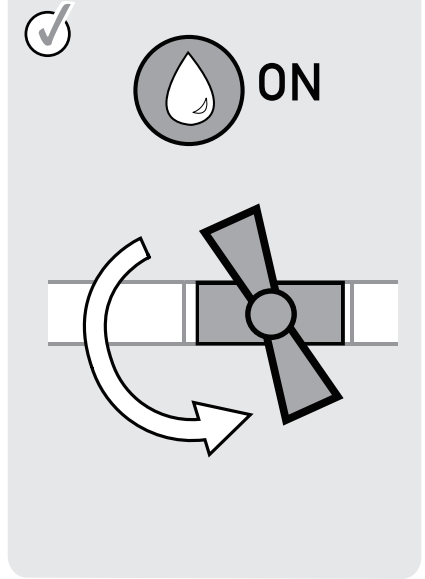

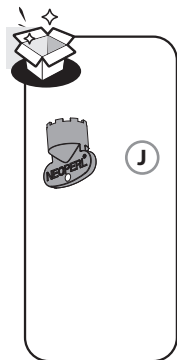

FR: Changement de mousseur/ ES: Cambio de aireador/ PT: Mudança de arejador/ IT: Cambio rompigetto/
 EL: Αλλαγή αεράτορα / PL: Wymiana perlatora / RU: Смена аэратора / KZ: Ауақанықтырғышты ауыстыру/
 UA: Заміна аератора/ RO: Schimbare aerator/ BR: Substituição do aerador/ EN: Replacing the aerator

1

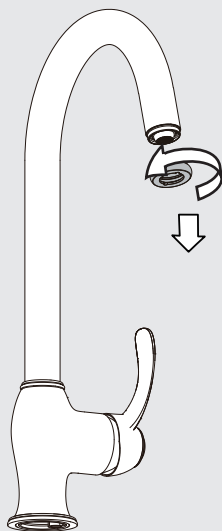

2

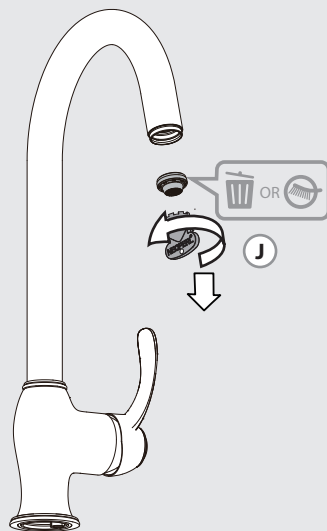

FR Nettoyage	EL Καθαρισμός	UA Очищення
ES Limpieza	PL Czyszczenie	RO Curățare
PT Limpeza	RU Чистка	BR Limpeza
IT Pulizia	KZ тазарту	EN Cleaning

3

FR Vinaigre	IT Aceto	RU Уксус	RO Oțet
ES Vinagre	EL Ξίδι	KZ Сірке су	BR Vinagre
PT Vinagre	PL Ocet	UA Оцет	EN Vinegar

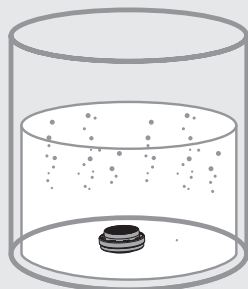

4

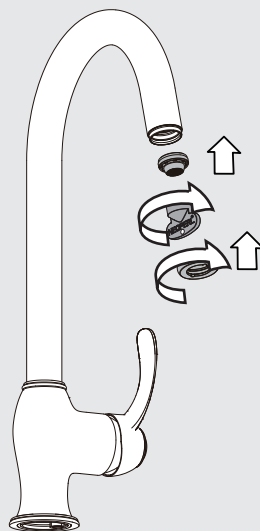

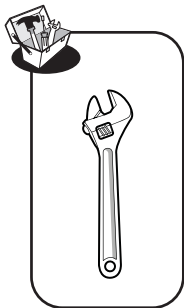

FR: Changement de flexibles/ **ES:** Cambio de flexibles / **PT:** Mudança de flexíveis/ **IT:** Cambio flessibili/
EL: Αλλαγή λάστιχων/ **PL:** Wymiana wężyków instalacyjnych / **RU:** Смена гибкого шланга для смесителя/
UA: Заміна гнучкого шланга для змішувача/ **KZ:** Қоспалауышқа арналған иілгіш шлангты ауыстыру/
RO: Schimbare furtune flexibile/ **BR:** Substituição das mangueiras/ **EN:** Replacing the hoses

1

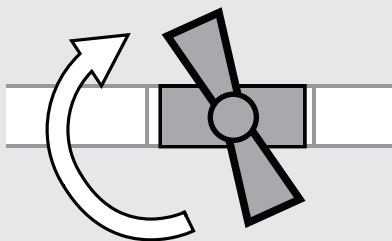

2

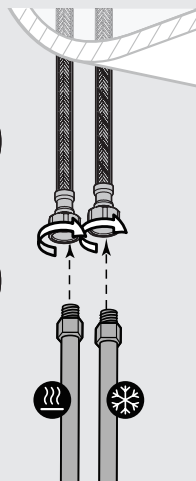

3



ON

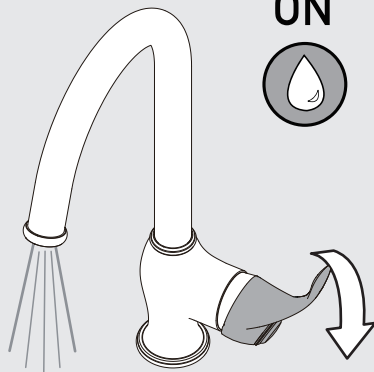

4

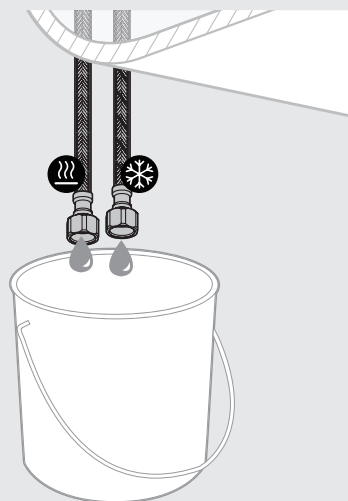

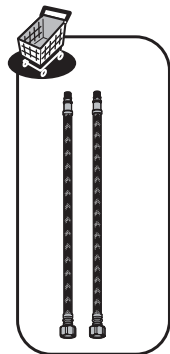

FR: Changement de flexibles/ ES: Cambio de flexibles / PT: Mudança de flexíveis/ IT: Cambio flessibili/
 EL: Αλλαγή λάστιχων/ PL: Wymiana wężyków instalacyjnych / RU: Смена гибкого шланга для смесителя/
 UA: Заміна гнучкого шланга для змішувача/ KZ: Қоспалауышқа арналған иілгіш шлангты ауыстыру/
 RO: Schimbare furtune flexibile/ BR: Substituição das mangueiras/ EN: Replacing the hoses

5

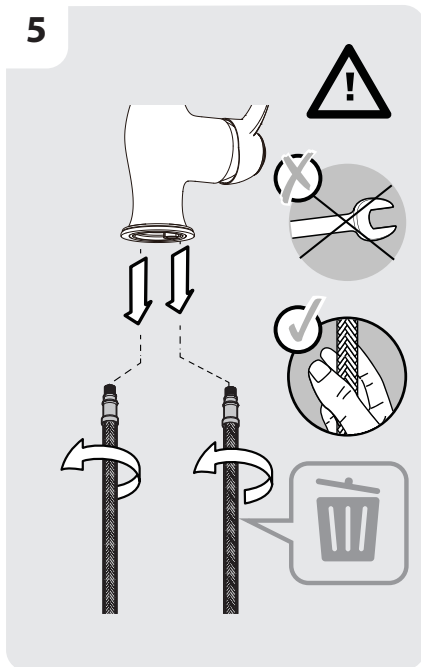

6

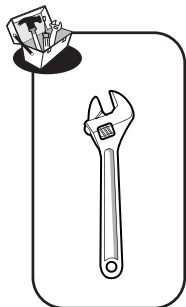
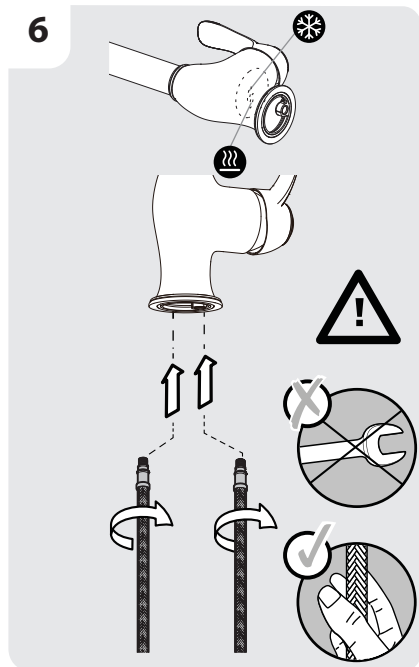

7

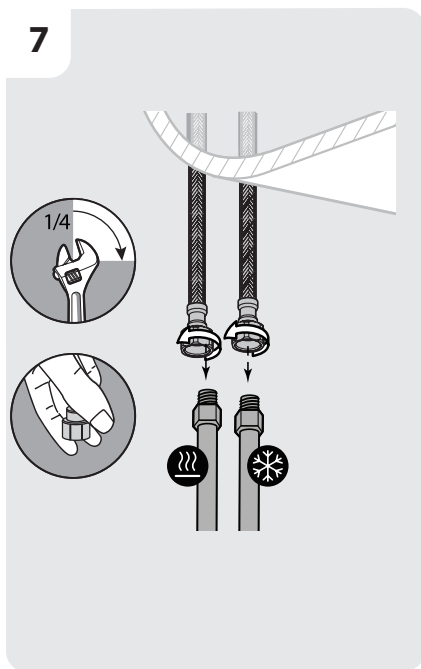

8

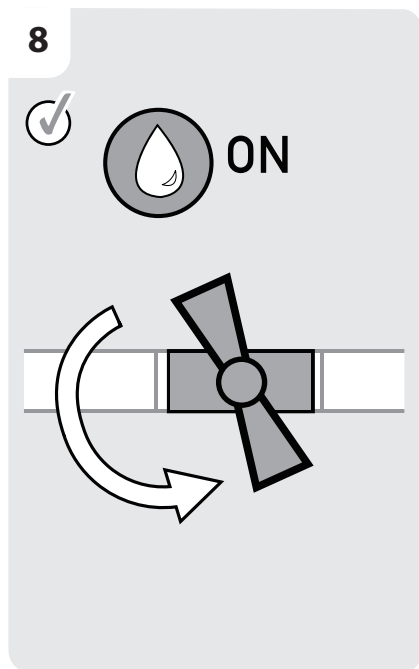



Eau claire / Agua limpia / Água limpa / Acqua pulita / Καθαρό νερό / Czysta woda / Чистая вода / Água limpa /
Чиста вода / Ara curata / таза су / Clean water



Sans solvant / Sin disolvente / Sem solventes / Senza solventi / Χωρίς διαλυτικά / Bez rozpuszczalnika / Без растворителя /
Sem solventes/ Без розчинника / Fara solvent / еріткішсіз/ Solvent-free

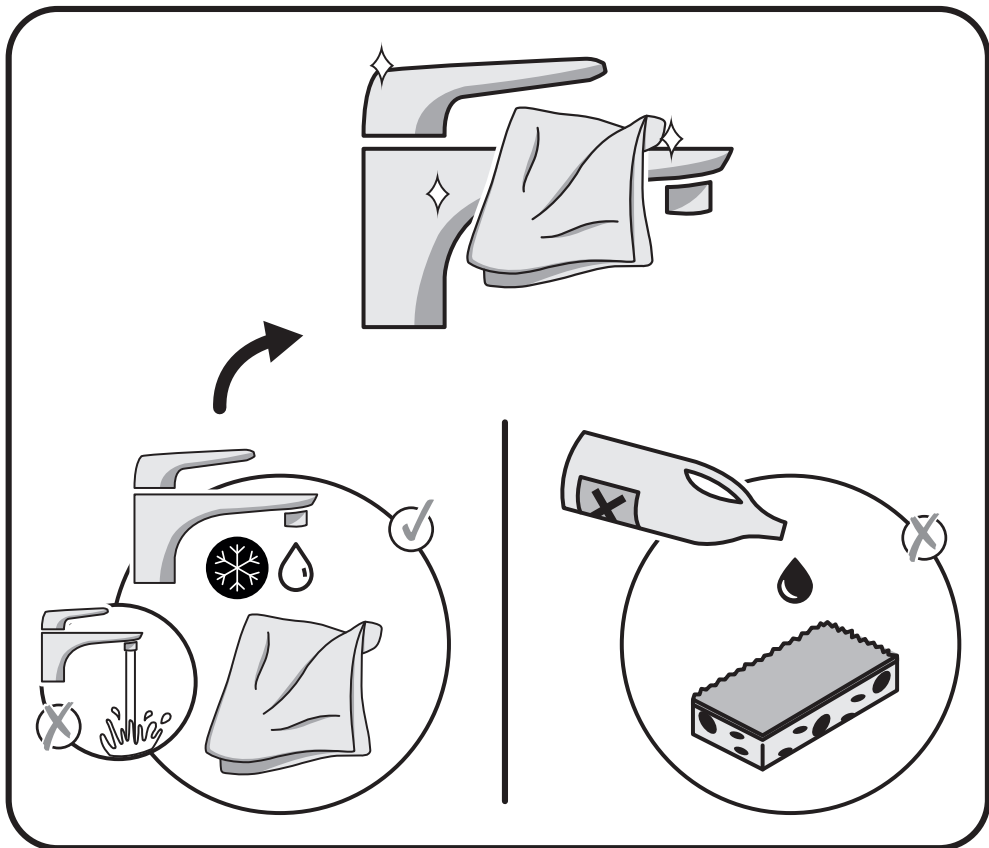



Part-listing				
No	Description	Code No	QTY	Remark
1	Handle Cover	B01-3116A01	1	
2	Handle	B01-3116A02	1	
3	Beautify Cover	B14-3116A03	1	
4	Pressing Nut	B15-3116A04	1	
5	Cartridge	EC40 CD COLD DUE MIRROR	1	
6	Fixing Part	C96-3116A05	1	
7	Flexible Hose	TAQ-PEX-DN6-ACB H3/8-M8x1 L12 550 MM(3276000596295)	2	
		TAQ-PEX-DN6-ACB H1/2-M8x1 L12 550 MM(3276000632436,3276000596738)		
8	Aerator	40.8430.010	1	
9	Aerator housing	B17-3116A06	1	
10	Aerator Key	09.9152.0	1	
11	Body	B00-3117A07	1	
12	Spout	B10-3116A08	1	
13	Connector	B13-3116A09	2	

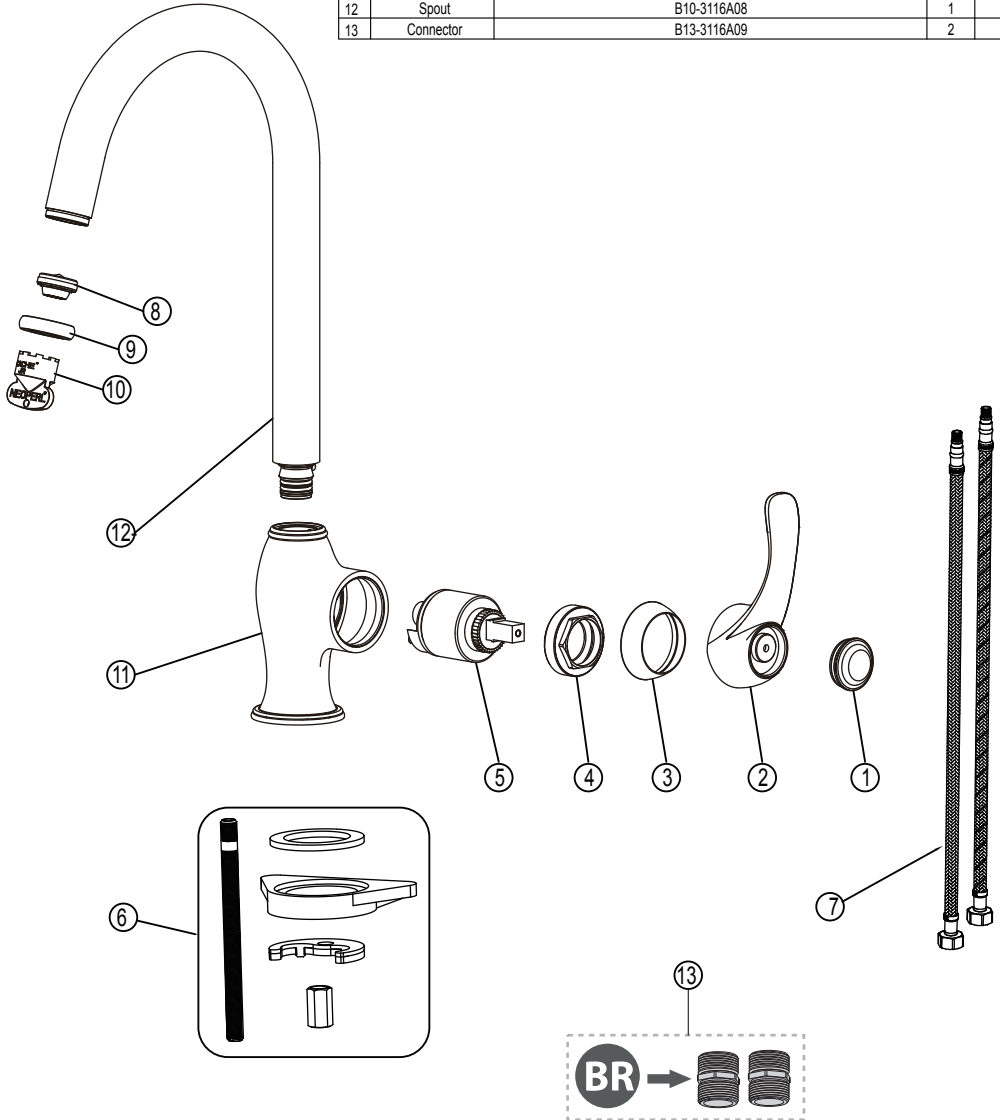



Certificado de conformidad sanitaria.
Atestado de conformidade sanitária.
certificato di conformità sanitaria.
Βεβαίωση υγειονομικής συμμόρφωσης.
Certyfikat zgodności sanitarnej.
Декларация о соответствии санитарным нормам
Санитарлық талаптарға сәйкестік декларациясы
Декларация про відповідність санітарним нормам
Atestat de conformitate sanitară
Certificado de conformidade sanitária.
Declaration of sanitary conformity.
Attestation de conformité sanitaire

* Garantie 10 ans / 10 años de garantía / Garantia de 10 años / Garanzia 10 Anni / Εγγύηση 10 ετών / Gwarancja 10-letnia / Гарантия 10 года / Кепілдік 10 жыл / Гарантія 10 років /
Garanție 10 ani / 10 anos de garantia / 10-year guarantee

Made in P.R.C 2018

ADEO Services - 135 Rue Sadi Carnot - CS 00001
59790 RONCHIN - France



ТОВ «Леруа Мерлен Україна»,
вул. Полярна 17а, м. Київ 04201, Україна

