

Altivar AFE

Active Front End

Option for Altivar 61 & Altivar 71

Operating instructions Modbus

04/2013



8 P02 517 EN:00/00

www.schneider-electric.com

Schneider
Electric

Important information

The information provided in this documentation contains general descriptions and/or technical characteristics of the performance of the products contained herein. This documentation is not intended as a substitute for and is not to be used for determining suitability or reliability of these products for specific user applications. It is the duty of any such user or integrator to perform the appropriate and complete risk analysis, evaluation and testing of the products with respect to the relevant specific application or use thereof. Neither Schneider Electric nor any of its affiliates or subsidiaries shall be responsible or liable for misuse of the information contained herein. If you have any suggestions for improvements or amendments or have found errors in this publication, please notify us.

No part of this document may be reproduced in any form or by any means, electronic or mechanical, including photocopying, without express written permission of Schneider Electric.

All pertinent state, regional, and local safety regulations must be observed when installing and using this product. For reasons of safety and to help ensure compliance with documented system data, only the manufacturer should perform repairs to components.

When devices are used for applications with technical safety requirements, the relevant instructions must be followed.

Failure to use Schneider Electric software or approved software with our hardware products may result in injury, harm, or improper operating results.

Failure to observe this information can result in injury or equipment damage.

© 2013 Schneider Electric. All rights reserved.

Modbus for the Active Front End AFE

This instructions describe the functions software version APSatvr_R1.1IE02 and higher

Theme	Page
Safety informations.....	3
Important information.....	4
Modbus.....	7
Function Modbus.....	8
Hardware	13
Process data area.....	21
Process data area.....	22
Control word.....	24
Status word	31
Main actual value (Auxiliary actual values).....	33
Parameterization.....	35
General	36
AFE settings.....	43
Bus - Diagnostics.....	49
Diagnostics of the "Bus raw data"	50
Bus coupling	51
Design.....	52
Appendix.....	53
List of parameters.....	54
Device messages.....	58

NOTICE

The instructions in hand cover the topics operation, parameterization and diagnostics of the Modbus interface of the Active Front End. Moreover, the principles of the Modbus architecture and their main components are explained in detail.

Use these instructions additionally to the device documentation "Description of functions" and "Mounting instructions".

NOTICE

In order to address an Active Front End via fieldbus also during mains cut-off (disconnecting switch, ...) the Active Front End AFE has to be supplied with an external 24 V buffer voltage.

Safety informations

04/2013

8 P02 517 EN.00/00

Important information

Read these instructions carefully, and look at the equipment to become familiar with the device before trying to install, operate, or maintain it. The following special messages may appear throughout this documentation or on the equipment to warn of potential hazards or to call attention to information that clarifies or simplifies a procedure.



The addition of this symbol to a Danger or Warning safety label indicates that an electrical hazard exists, which will result in personal injury if the instructions are not followed.



This is the safety alert symbol. It is used to alert you to potential personal injury hazards. Obey all safety messages that follow this symbol to avoid possible injury or death.

DANGER

DANGER indicates an imminently hazardous situation, which, if not avoided, **will result in death or serious injury**.

WARNING

WARNING indicates a potentially hazardous situation, which, if not avoided, **can result in death, serious injury or equipment damage**.

CAUTION

CAUTION indicates a potentially hazardous situation, which, if not avoided, **can result in injury or equipment damage**.

CAUTION

CAUTION, used without the safety alert symbol, indicates a potentially hazardous situation which, if not avoided, **can result in equipment damage**.

NOTICE

REMARK explains a proceeding without any potentially hazardous situation.

The word "drive" as used in this manual refers to the control part of the adjustable speed drive as defined by NEC.

Electrical equipment should be installed, operated, serviced, and maintained only by qualified personnel. No responsibility is assumed by Schneider Electric for any consequences arising out of the use of this product.

© 2013 Schneider Electric. All rights reserved.

 **DANGER**

HAZARD OF ELECTRIC SHOCK, EXPLOSION, OR ARC FLASH

- Read and understand this document carefully before installing or operating the Active Front End. Installation, adjustment and repair must be performed by qualified personnel.
- The user is responsible for compliance with all international and national electrical standards concerning protective grounding of the whole equipment.
- Many parts of this drive controller, including the printed circuit boards, are supplied with line voltage. Do not touch these components.
Only use electrically insulated tools.
- Do not touch unshielded components or terminal screws when the device is energised.
- Do not short the terminals PA/+ and PC/- as well as the DC link capacitors.
- Install and close all the covers before applying power on the drive controller.
- Execute the following precautions before maintenance or repair of the drive controller:
 - Disconnect the power supply. The circuit breaker or disconnecting switch does not always open all circuits!
 - Check whether the system is without voltage.
 - Place a “DO NOT TURN ON” label on the drive controller disconnect.
 - Lock the circuit breaker or disconnecting switch in the opened position.
- Measure the voltage of the DC bus before any work at the Active Front End in order to check whether the DC voltage is below 42 V. There may be voltage at the capacitors of the Active Front End even when it is disconnected from the mains. The LED which indicates the present DC bus voltage at some devices is not sufficient.

Failure to follow these instructions will result in death or serious injury.

04/2013

 **DANGER**

UNINTENDED OPERATION OF THE DEVICE

- Read and understand the programming manual before operating the drive.
- Any changes made to the parameter settings must be performed by qualified personnel.
- To avoid an unintentional restart ensure that the input PWR (POWER REMOVAL) is deactivated (state 0) before you switch the frequency inverter on to configure it.
- Before switching on the device or when exiting the configuration menu, ensure that the inputs which are used as run commands are deactivated (state 0) because they promptly could cause a start of the motor.

Failure to follow these instructions will result in death or serious injury.

8 P02 517 EN.00/00

 **WARNING**

DAMAGE OF THE DEVICE

Do not install or operate the drive or accessories, when they are damaged.

Failure to follow this instruction can result in death, serious injury or equipment damage.

 **WARNING**

RISK OF TOPPLING

Do not stand the drive upright. Keep the drive on the pallet until it is installed.

Use a hoist for installation. Therefore the components are equipped with handling lugs.

Failure to follow this instruction can result in death, serious injury or equipment damage.

Electromagnetic fields "electro smog"

Electromagnetic fields are generated by the operation of electrical power engineering installations such as transformers, inverters or motors.

WARNING

ELECTROMAGNETIC FIELDS "ELECTRO SMOG"

Take appropriate measures, labels and hazard warnings to adequately protect operating personnel and others against any possible risk:

- Observe the relevant health and safety regulations.
- Display adequate hazard warning notices.
- Place barriers around hazardous areas.
- Take measures, e.g. using shields, to reduce electromagnetic fields at their source.
- Do not allow persons with heart pacemakers to access areas with electromagnetic fields. They can interfere with electronic devices (like heart pacemakers), which could cause them to malfunction.
- Make sure that personnel are wearing the appropriate protective equipment.

Failure to follow this instruction can result in death, serious injury or equipment damage.

CAUTION

INCOMPATIBLE LINE VOLTAGE

Before switching-on and configuring the drive, ensure that the line voltage and frequency is compatible with the supply voltage range shown on the drive nameplate. The existing nominal mains voltage must be set at the device by means of a parameter. Thereby an optimal adjustment of the undervoltage protective function takes place.

Failure to follow this instruction can result in injury or equipment damage.

04/2013

8 P02 517 EN.00/00

04/2013

8 P02 517 EN.00/00

Function Modbus

The Active Front End units support the fieldbus system Modbus as standard. It is coupled at the RJ45 socket next to the terminals of the Active Infeed Converter (see chapter "Modbus connection", page 14).

In the Modbus network the Active Front End is operated as a slave. The used profile is designed on the basis of the Drivecom profile but it can be also switched to the Profidrive profile VDI/VDE 3689.

Principle function

The data transfer in a Modbus network takes place via the serial device interface (RS485 2-wire) with a master/slave method.

Only the Modbus master can send commands (request) to the other bus subscribers. Depending on the command, the reaction (response) of the individual slave devices is either to send the desired data or to confirm the execution of the desired operation function. During transfer of the data, request and response constantly alternate.

The master sends commands to the slave device. This slave sends data only when prompted to do so by the master device. The data exchange thus follows a fixed scheme. The sequence is seen from the viewpoint of the Modbus master.

The commands are embedded in the transferred data frame in the form of function codes. The request of the master contains a function code that represents a command to be executed for the slave device. In the process, the transferred data bytes contain the information required for the execution of the command. The parity bytes enable the slave unit to check the integrity of the data received. The response of the slave device contains the function code of the request as an "echo."

The data bytes of the response (slave to master) depend on the function code used and are provided by the slave device. The parity bytes enable the master to check the validity of the received data.

The structure of the sent data is defined in various Modbus protocols.

In addition to the Modbus RTU (master/slave communication in binary code) there are also the formats Modbus-ASCII and Modbus-PLUS.

The Altivar AFE devices support the Modbus RTU protocol.

Structure of the telegram

The telegram structure of a Modbus frame consists of the address of the slave being addressed, the desired request code, a data field of variable length and a 16-bit CRC to allow data consistency.

The end of the telegram is recognized by a pause ≥ 3.5 bytes. The structure of a byte can be set using parameter 4.6.12 Modbus format.

The transfer of the telegrams takes place according to the master/slave system through the entry of the desired slave address in confirmed form. When a value of zero is used as the slave address, the telegram applies for all slaves (broadcast service).

The permissible address range of the individual slaves is 1...247. There may not be two or more devices with the same address at the bus.

NOTICE
To set up a single-point connection (network consists of only one master and one slave), the master can use the address 248. When using this address, the slave responds independent of its address which is set by 4.6.10 Modbus address.

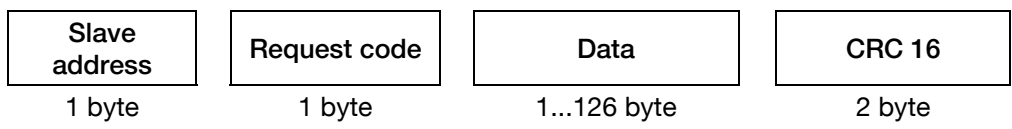

Creating CRC 16

CRC 16 is calculated according to the following method for checking the data consistency:

- Initialize CRC (16-bit register) to hex FFFF
- Execution from the first to the last byte of the message:
 - CRC XOR <Byte> → CRC
 - Execute (8 times)
 - Move CRC by 1 bit to the right
 - If output bit = 1, CRC XOR A001 hex → execute CRC
 - End of execution
- The CRC value which is calculated that way is initially transferred with the low-order byte and then with the high-order byte.

NOTICE

Detailed information about the Modbus specification is given on www.modbus.org (Modbus_over_serial_line_specification_and_implementation_guide_V1_02.pdf edition 2006).

Modbus functions / request code

Request code hex	Modbus function	Broadcast	Description	Use
03 hex	Read Holding Registers	No	Reading of a single parameter (16 bit) or a maximum of 63 parameters with consecutive logical address	Parameterization, Process data ZTW + IW
06 hex	Write Single Register	Yes	Writing of a single parameter (16 bit)	Parameterization
08 hex	Diagnostics	No	Service for fieldbus diagnostics (requests with subcodes)	Diagnostics
10 hex	Write Multiple Register	No	Request for writing several words with consecutive logical addresses	Process data STW
17 hex	Read/write multiple reg.	No	Request for writing and reading several words with consecutive logical addresses	Process data STW, ZTW + IW

04/2013

8 P02 517 EN.00/00

Structure of the Modbus user data

The available request codes of the Modbus provide services for various tasks.

Diagnostic functions (request code hex 08)

Using the request code 08 hex and its subcodes, bus-specific information can be read in order to evaluate the quality of transmission statistically.

Request telegram Master → Altivar AFE

Slave address	Request	Subcode		Request data		CRC 16	
	08 hex	Hi	Lo	Hi	Lo	Lo	Hi
1 byte	1 byte	2 bytes		2 bytes		2 bytes	

Response telegram Altivar AFE → Master

Slave address	Response	Subcode		Response data		CRC 16	
	08 hex	Hi	Lo	Hi	Lo	Lo	Hi
1 byte	1 byte	2 bytes		2 bytes		2 bytes	

Subcode	Request data	Response data	Description
00	XX YY	XX YY	The request causes an echo at the respective slave. The response telegram of the slave is a copy of the request telegram.
0A	00 00	00 00	Reset counter
0C	00 00	= actual value of the counter	Reading out the CRC Diagnostic Message counter (number of the inconsistent received telegrams)
0E	00 00	= actual value of the counter	Reading out the telegram counter (number of the telegrams received from the slave, independent of the type of telegram)

04/2013
8 P02 517 EN.00/00

Parameterization of the Active Front End AFE (request code hex 03, 06)

By means of the services Read (03 hex) and Write (06 hex) of parameters the device-internal parameters can be accessed via their logical address.

NOTICE

For details, see chapter "Parameterization", page 35.

Monitoring and control of the Active Front End AFE (request codes hex 03, 17)

By means of the services Read (03 hex) and Write/Read (17 hex) of multiple registers access to device-internal addresses of the control word and status word as well as to the available actual values is possible.

Therewith pure monitoring as well as complete control of the Active Front End is possible. The design of the device-internal drive profile is based on the Drivecom profile (VDI/VDE 3689).

Unlike the telegram structure predefined by the Profidrive profile (PPO types 1...5), the lengths of the telegrams can be freely defined for both directions (master → slave / slave → master) in Modbus. As a result the telegram length can be optimized according to the existing requirements of the process.

Example of a Modbus user data telegram

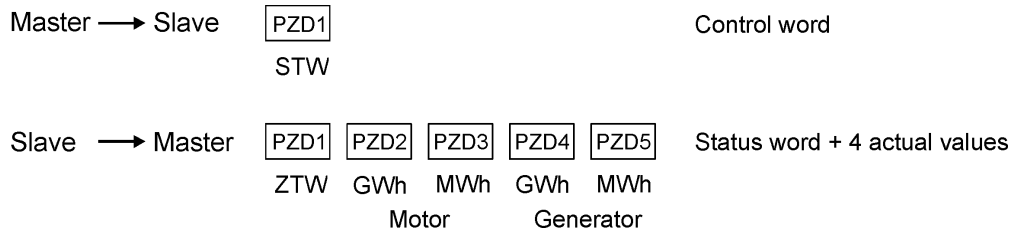

Master → Altivar AFE

For control of the Active Front End AFE only the control word with address 51D hex is used. No reference values are used.

Word	PZD1
User data	STW
Logical address (hex)	51D
Configuration	---

PZD ... Process data word

STW ... Control word, 16 bit chain of commands

Altivar AFE → Master

The addresses FA...103 hex are used to read out information provided by the Active Front End AFE like status word and actual values. The number of device-internal, really processed actual values is defined to four actual values. The actual values are configured by means of parameters 4.6.40...4.6.55.

Word	PZD1	PZD2	PZD3	PZD4	PZD5
User data	ZTW	IW 1	IW 2	IW 3	IW 4
Logical address (hex)	FA	FB	FC	FD	FE
Configuration		4.6.40	4.6.44	4.6.48	4.6.52

PZD ... Process data word

ZTW ... Status word, 16 bit chain of commands

IW ... Actual value, 16 bit display, -200...+200 %, resolution 2^{-14}

NOTICE

A detailed description of the control word and status word can be found in chapter "Process data area", page 22.

Structure of the network

The typical Modbus topology corresponds to an RS485 2-wire serial bus network with drop lines. The individual subscribers are connected using a 2-wire, screened (shielded) twisted cable (typ. Cat 5), whereby only the signals D0, D1 and Common are connected.

According to the Modbus recommendations, both bus lines are to be connected with one 450...650 Ω resistor against 5 V and ground when installing the master. At both ends of the bus segment, the bus cable is to be terminated with a 120 Ω resistor and a serially connected 1 nF capacitor.

At every bus segment, a maximum of 32 subscribers (including repeater) can be operated. The maximum line extension amounts to 1000 m at 19.2 kBaud. Principally, the drop lines have to be kept as short as possible (max.. 20 m for a single line, 40 m in total in case of centralized distribution).

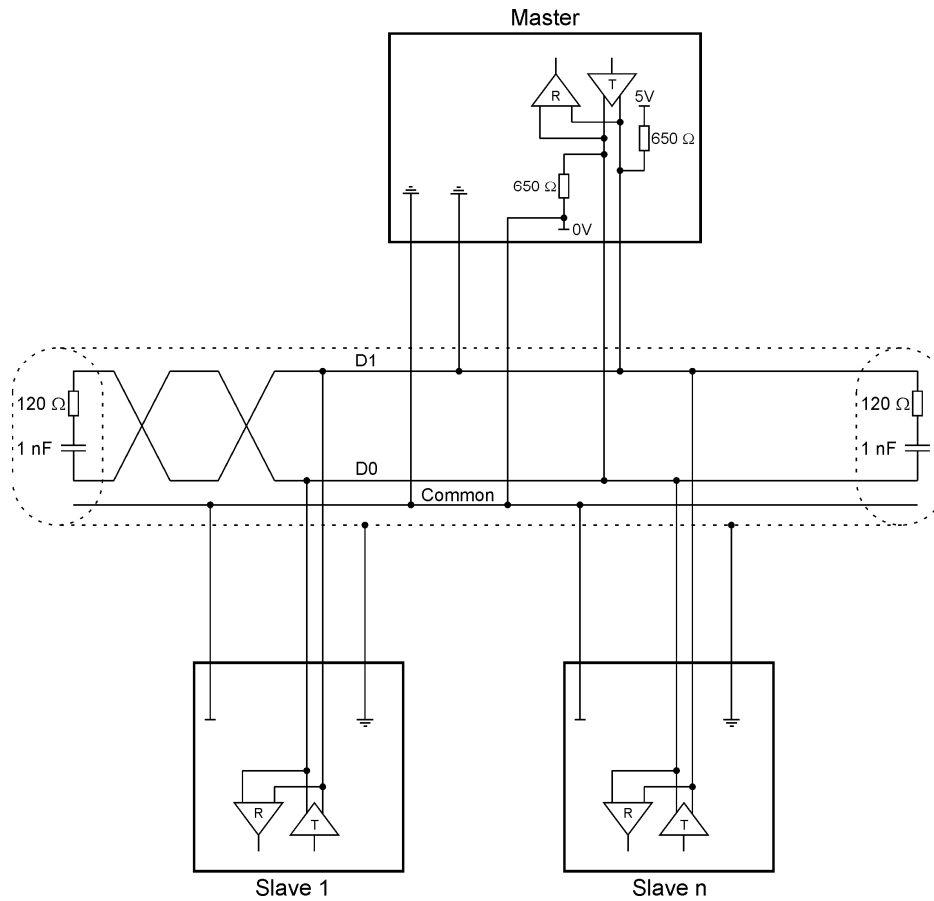

04/2013

8 P02 517 EN.00/00

Technical key data of a Modbus network

Maximum number of subscribers:	247 in all segments
Maximum number of subscribers per segment:	32 including the repeater
Bus cable:	Screened (shielded), 2 x twisted, two-wire line Characteristic impedance: 100...120 Ω Distributed capacitance: < 60 nF/km Loop resistance: < 160 Ω/km Wire cross-section: > 0.22 mm ²
Bus connection:	RJ45 - screened (shielded), pin assignment 4, 5, 8
Bus termination:	Every bus segment has to be terminated using a serial connection of R = 120 Ω and C = 1 nF.
Galvanic isolation:	No

NOTICE

Detailed information about the Modbus specification is given on www.modbus.org (Modbus_over_serial_line_specification_and_implementation_guide_V1_02.pdf edition 2006).

04/2013

8 P02 517 EN.00/00

Modbus connection

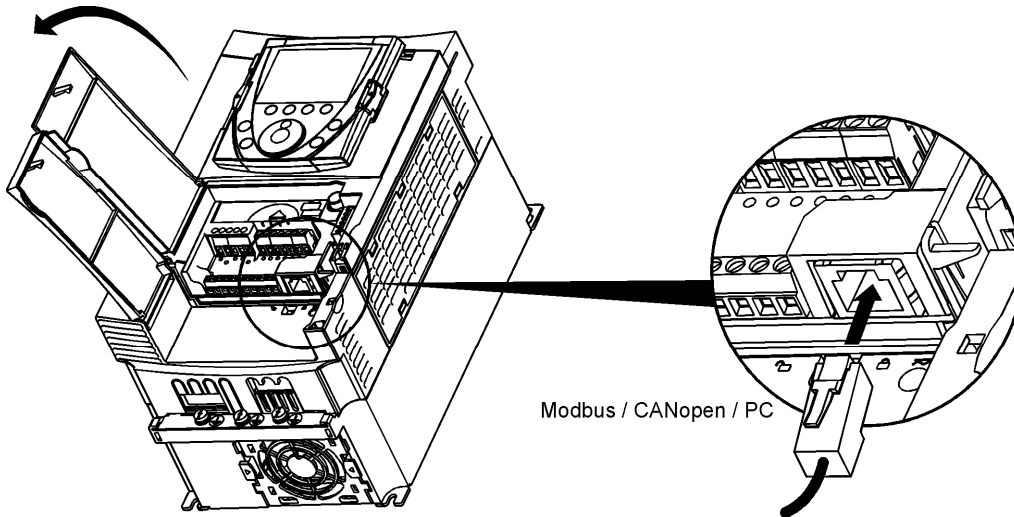

Plug assignment

Pin assignment of the RJ45 device interface

Pin	Signal
1	CAN_H
2	CAN_L
3	CAN_GND
4	D1 *)
5	D0 *)
6	Not used
7	VP **)
8	Common *)

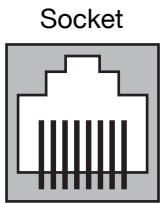

*) Modbus signals

**) Supply voltage for the RS232/485 interface converter (TSX SCA 72)

The RJ45 socket (in the duct next to the control terminals) can be used as serial interface for the fieldbus systems Modbus and CANopen. When building up a Modbus network, only the signals of pins 4, 5 and 8 may be used.

WARNING

DAMAGE OF THE DEVICE

Connect only pins 4, 5 and 8 when using the Modbus interface.

Failure to follow this instruction can result in death, serious injury or equipment damage.

Consequently, connection is possible in 2 different ways:

1. Using the optional Modbus T-adapter



The Modbus T-adapter provides two RJ45 sockets for further bus wiring. On both sockets, which are connected in parallel, only pins 4, 5 and 8 are connected so that also pre-assembled cables (1:1 connection) can be used.

The Modbus T-adapter is available in two different lengths.

- VW3 A8 306 TF03 Modbus T-adapter with 0.3 m connecting cable
- VW3 A8 306 TF10 Modbus T-adapter with 1 m connecting cable

Example of a bus structure with T-adapter:

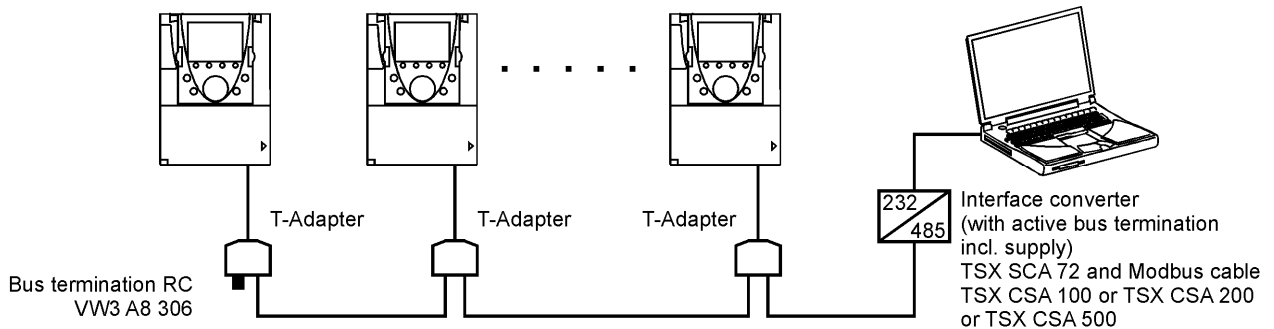

04/2013

2. Using the optional Modbus splitter or an external junction box

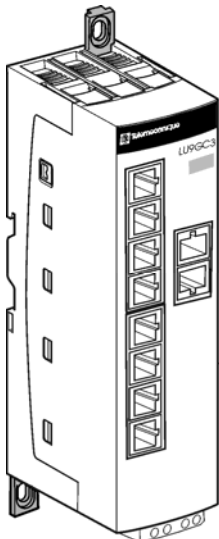

When no Modbus T-adapter is used, please ensure that only the three pins 4, 5 and 8 at the RJ45 connector of the bus connection are connected. Using the PHOENIX CONTACT VARIOSUB RJ45 QUICKON connector is a simple and capable solution to establish a connection between the bus subscriber and the Modbus splitter.

- LU9GC3 Passive Modbus splitter
- VS-08-RJ45-5-Q/P20 RJ45 connector VARIOSUB RJ45 QUICKON

8 P02 517 EN.00/00

Example of a bus structure with Modbus splitter:

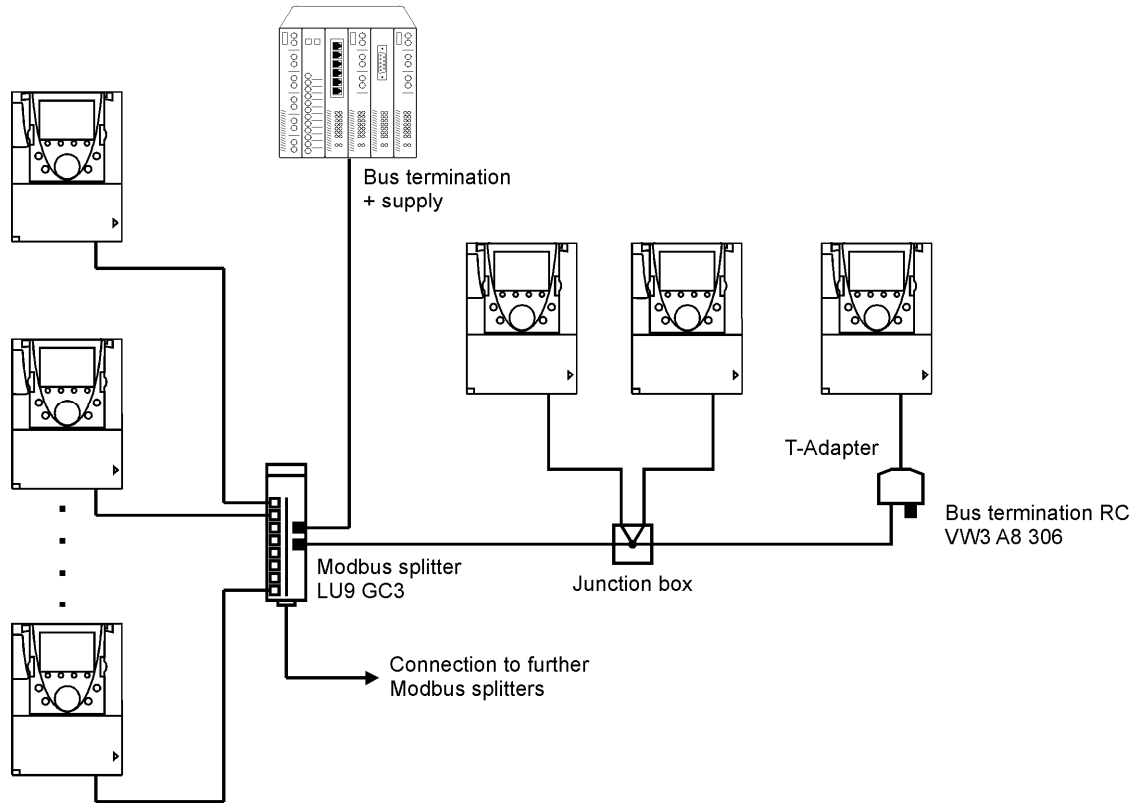

Accessories for connection			
Description			Order number
Modbus splitter	10 RJ45 plug and 1 terminal block		LU9 GC3
Modbus T-adapter	with integrated cable (0.3 m)		VW3 A8 306 TF03
	with integrated cable (1.0 m)		VW3 A8 306 TF10
Terminating resistor	for RJ45 plug $R=120\Omega$, $C=1nF$		VW3 A8 306 RC

Connecting cable			
Description	Length (in m)	Connection method	Order number
Modbus cable	3	1 RJ45 plug and 1 stripped cable end	VW3 A8 306 D30
	0.3	2 RJ45 plugs	VW3 A8 306 R03
	1	2 RJ45 plugs	VW3 A8 306 R10
	3	2 RJ45 plugs	VW3 A8 306 R30
RS485 double screened (shielded) and twisted cable	100	without plug	TSX CSA 100
	200	without plug	TSX CSA 200
	500	without plug	TSX CSA 500

04/2013

8 P02 517 EN.00/00

Bus connections			
Type of bus master	Interface	Accessories for RJ45 wiring Description	Order number
Twido PLC	Adapter or mini-DIN RS485 interface module	3 m cable with 1 RJ45 plug and 1 mini-DIN plug	TWD XCA RJ030
	Adapter or screw terminals RS485 interface module	3 m cable with 1 RJ45 plug and 1 stripped cable end	VW3 A8 306 D30
TSX Micro PLC	Mini-DIN RS485 connector	3 m cable with 1 RJ45 plug and 1 mini-DIN plug	TWD XCA RJ030
	PCMCIA card (TSX SCP114)	2 stripped cable ends	TSX SCP CM 4030
TSX Premium PLC	TSX SCY 11601 or TSX SCY 21601 module (SUB-D 25 -socket)	1 SUB-D 25 plug and 1 stripped cable end (for connection with LU9GC3 Modbus splitter)	TSX SCY CM 6030
	PCMCIA card (TSX SCP 114)	2 stripped cable ends	TSX SCP CM 4030
Ethernet bridge (174 CEV 300 10)	Terminal block RS485	3 m cable with 1 RJ45 plug and 1 stripped cable end	VW3 A8 306 D30
Profibus DP gateway (LA9P307)	RJ45 RS485	1 m cable with 2 RJ45 plugs	VW3 P07 306 R10
Fipio (LUFP1) or Profibus DP (LUFP7) or DeviceNet (LUFP9) gateway	RJ45 RS485	0.3 m or 1 m or	VW3 A8 306 R03 or VW3 A8 306 R10 or
		3 m cable with 2 RJ45 plugs	VW3 A8 306 R30
Serial PC interface	male SUB-D 9 RS232 serial PC interface	RS232/RS485 compiler and 3 m cable with 1 RJ45 plug and 1 stripped cable end (for connection with LU9GC3 Modbus splitter)	TSX SCA 72 and VW3 A8 306 D30

04/2013

8 P02 517 EN.00/00

Example of a bus structure with junction boxes:

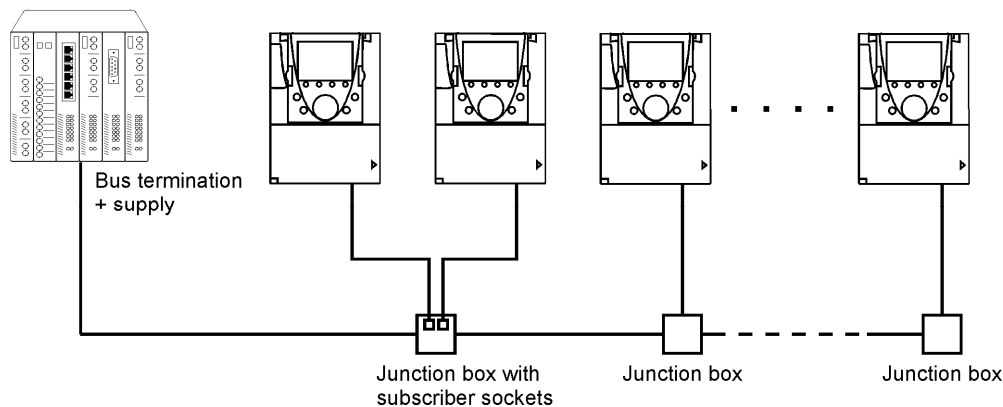

Accessories for connection		
Description		Order number
Junction box	3 screw terminals and one RC bus termination, for connection of cable VW3 A8 306 D30	TSX SCA 50
Junction box with subscriber sockets	2 female 15-way SUB-D plug, 2 screw terminals and one RC bus termination, for connection of cable VW3 A8 306 or VW3 A8 306 D30	TSX SCA 62

Connecting cable			
Description	Length (in m)	Connection method	Order number
Modbus cable	3	1 RJ45 plug and 1 stripped cable end	VW3 A8 306 D30
	3	1 RJ45 plug and 1 male 15-way SUB-D plug for TSX SCA 62	VW3 A8 306
RS485 double screened (shielded) and twisted cable	100	without plug	TSX CSA 100
	200	without plug	TSX CSA 200
	500	without plug	TSX CSA 500

04/2013

8 P02 517 EN.00/00

Bus connections			
Type of bus master	Interface	Accessories for junction boxes with screw terminals	
		Description	Order number
Twido PLC	Adapter or screw terminals RS485 interface module	Modbus cable	TSX CSA100 TSX CSA200 TSX CSA500
TSX Micro PLC	Mini-DIN RS485 connector PCMCIA card (TSX SCP114)	Junction box Cable equipped with 1 special plug and 1 stripped cable end	TSX P ACC 01 TSX SCP CU 4030
TSX Premium PLC	TSX SCY 11601 or TSX SCY 21601 module (SUB-D 25 -socket) PCMCIA card (TSX SCP 114)	Cable with 1 SUB-D 25 plug and 1 stripped cable end Cable with 1 special plug and 1 stripped cable end	TSX SCY CM 6030 TSX SCP CU 4030
Ethernet bridge (174 CEV 300 10)	Terminal block RS485	Modbus cable	TSX CSA100 or TSX CSA200 or TSX CSA500
Profibus DP gateway (LA9P307)	RJ45 RS485	3 m cable with 1 RJ45 plug and 1 stripped cable end	VW3 A8 306 D30
Fipio (LUFP1) or Profibus DP (LUFP7) or DeviceNet (LUFP9) gateway	RJ45 RS485	3 m cable with 1 RJ45 plug and 1 stripped cable end	VW3 A8 306 D30
Serial PC interface	male SUB-D 9 RS232 serial PC interface	RS232/RS485 compiler and Modbus cable	TSX SCA 72 and TSX CSA100 or TSX CSA200 or TSX CSA500

Type of bus master	Interface	Accessories for junction boxes with SUB-D 25 plug	
		Description	Order number
Twido PLC	Adapter or screw terminals RS485 interface module	–	–
TSX Micro PLC	Mini-DIN RS485 connector PCMCIA card (TSX SCP 114)	– Cable equipped with 1 special plug and 1 SUB-D 25 plug	– TSX SCY CU 4530
TSX Premium PLC	TSX SCY 11601 or TSX SCY 21601 module (SUB-D 25 -socket) PCMCIA card (TSX SCP 114)	Cable with 1 SUB-D 25 plug and 1 stripped cable end Cable with 1 special plug and 1 stripped cable end	TSX SCP CU 4530 TSX SCP CU 4530
Ethernet bridge (174 CEV 300 10)	Terminal block RS485	–	–
Profibus DP gateway (LA9P307)	RJ45 RS485	–	–
Fipio (LUFP1) or Profibus DP (LUFP7) or DeviceNet (LUFP9) gateway	RJ45 RS485	3 m cable with 1 RJ45 plug and 1 SUB-D 25 plug	VW3 A8 306
Serial PC interface	male SUB-D 9 RS232 serial PC interface	–	–

Accessories for screw terminals		
Description		Order number
RC bus termination	R = 120 Ω, C = 1 nF	VW3 A8 306 DRC

Connecting cable			
Description	Length (in m)	Connection method	Order number
Modbus cable	3	1 RJ45 plug and 1 stripped cable end	VW3 A8 306 D30
RS485 double screened (shielded) and twisted cable	100 200 500	without plug without plug without plug	TSX CSA 100 TSX CSA 200 TSX CSA 500

Process data area

04/2013

8 P02 517 EN.00/00

Process data area

The exchange of process data takes place using the Modbus request telegram code 17 hex. Therefore the status word with 1...4 actual values is sent as a response telegram to the master when the Active Front End receives a data telegram (consisting of the control word). Typically, these telegrams are sent by the master cyclically to the individual slaves. The achievable cycle time depends on the bus structure, the number of bus subscribers and the transmission rate. The data are processed device-internal in a background task (typically 10...50 ms).

Example of a process data telegram to the slave with address 10

Read process data: Status word + 4 actual values, log. address of ZTW 250 dec = 00FA hex
 Write process data: Control word, log. address of STW 1309 dec = 051D hex
 STW= 047F

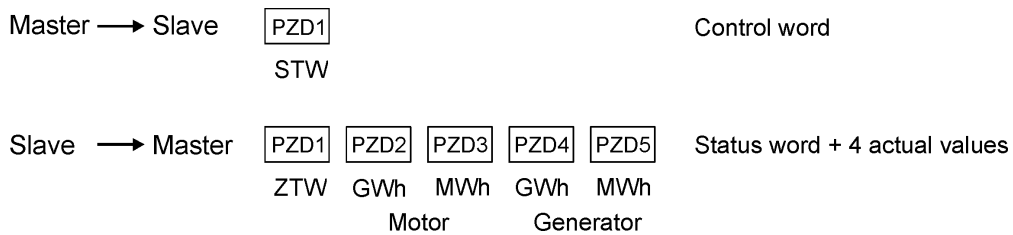

Request telegram Master → Altivar AFE

Slave address	Request	Start address "read" (ZTW)		Number of words to be read (ZTW +IW)		Start address "write" (STW)		Number of words to be written (STW)	
		Hi	Lo	Hi	Lo	Hi	Lo	Hi	Lo
1 byte	17 hex	2 bytes		2 bytes		2 bytes		2 bytes	

Number of "write" bytes	Word 1		CRC 16	
	Hi	Lo	Lo	Hi
02 hex	2 bytes		2 bytes	

Summary of the request telegram

Slave	Code	ZTW address		Number of parameters		STW address		Number of parameters		Number of bytes	Word 1		CRC *)	
		00	FA	00	07	05	1D	00	01		02	04	7F	39
0A	17	00	FA	00	07	05	1D	00	01	02	04	7F	39	A3

*) Calculation of the CRC algorithm, see chapter "Structure of the telegram", page 8.

Response telegram Altivar AFE → Master

Slave address	Response	Number of read bytes	Word 1		---	Word X		CRC 16	
	17 hex		Hi	Lo	---	Hi	Lo	Lo	Hi
1 byte	1 byte	1 byte	2 bytes			2 bytes		2 bytes	

Summary of the response telegram

Slave	Code	Number of bytes		Word 1		Word 2		Word 3		Word 4		---
0A	17	0E		01	B7	40	00	20	00	20	00	---
---		Word 5		Word 6		Word 7		CRC				
---		00	00	00	00	00	00	Lo	Hi			

- ZTW = 01B7
- ITW 1 = 4000hex (f is 100%)
- ITW 2 = 2000hex (P is 50%)
- ITW 3 = 2000hex (I is 50%)

NOTICE

When the Modbus should be used only for monitoring purposes, the "Read Holding Registers" (Multiple Read) code 03 hex telegram should be used.

In special cases, the individual access to the respective elements of the process data is possible using commands 03 hex, 06 hex, and 10 hex.

Control word

Assignment

Bit 15	-	
Bit 14	-	
Bit 13	-	
Bit 12	Trip request	
Bit 11	-	
Bit 10	Control O.K.	No control
Bit 9	-	-
Bit 8	-	-
Bit 7	Reset	-
Bit 6	-	-
Bit 5	-	-
Bit 4	-	-
Bit 3	Release operation	Lock operation
Bit 2	Operating condition	OFF 3
Bit 1	Operating condition	OFF 2
Bit 0	On	OFF 1
	High = 1	Low = 0

04/2013

8 P02 517 EN.00/00

Description of control word bits

Bit	Value	Meaning	Comment
0	1	ON	– Is accepted when the drive state is "1 .. Ready to switch on" and changes to drive state "3 .. Ready to run" when the DC link is already charged.
	0	OFF 1	– When the command has been accepted, the drive state changes to "13 .. OFF1 active" and thus the DC voltage is switched off.
1	1	Operating condition	"OFF 2" command canceled
	0	OFF 2	– When the command has been accepted, the Active Front End will be locked and the drive state changes to "19 .. Lock switching on". – When the basic state (bit 1 = 0, bit 2 = 1, bit 3 = 1 and bit 10 = 1) is given, the drive state changes to "1 .. Ready to switch on". The OFF 2 command can also be triggered by means of the terminal function Impulse enable !
2	1	Operating condition	"OFF 3" command canceled
	0	OFF 3	– When the command has been accepted, the drive state changes to "14 .. OFF3 active".
3	1	Operation released	When the command has been accepted, the Active Front End is released (Impulse enable) in drive state "3 .. Ready to run" and afterwards the drive state changes to "4 .. Operation released".
	0	Lock operation	– When the command has been accepted, the Active Front End will be locked and the drive state changes to "3 .. Ready to run". – If the drive state is "13 .. OFF1 active", the Active Front End will be locked and the drive state changes to "0 .. Not ready to switch on". – When the basic state (bit 1 = 0, bit 2 = 1, bit 3 = 1 and bit 10 = 1) is given, the drive state changes to "1 .. Ready to switch on". – If the drive state is "14 .. OFF 3 active", the procedure is executed all the same !
4	x	Not used	
5	x	Not used	
6	x	Not used	
7	1	Reset	– The reset command is accepted at the positive edge when the drive state is "20 .. Fault". – When there is no fault detected anymore, the drive state changes to "19 .. Lock switching-on". – If the detected fault is still remaining the drive state is furthermore "20 .. Fault". The reset command can also be triggered by means of the terminal function "Ext. reset" as well as by means of the Stop/Reset key on the keypad.
	0	no meaning	
8	x	Not used	
9	x	Not used	

04/2013

8 P02 517 EN.00/00

Bit	Value	Meaning	Comment
10	1	Control O.K.	When the command has been accepted, the DP slave is controlled via the bus interface. The process data become valid. This bit has to be set in order to accept control commands and/or the free bits as well as analog signals !
	0	No control	<ul style="list-style-type: none"> – When the command has been accepted, data are processed depending in status bit 9 "<i>Control requested</i>". Control requested = 1 → Behaviour according to bus fault – If the DP slave requests control furthermore, the Active Front End switches over to trip state (depending on the setting of parameter 4.6.03 "Bus error reaction"). In this case an alarm message is set ! Control requested = 0 → Data to 0 ! → only I/O or panel operation

Summary of the typical control commands

Function	Control word	
	Binary	Hexadecimal
ON	0000010001111111	47F
Start		
OFF 1	0000010001111110	47E
Stop	corresponds with the "basic state"	
OFF 2	0000010001111101 results in drive state Lock switching-on !	47D
OFF 3	0000010001111011 results in drive state Lock switching-on !	47B
Reset	xxxxx1xx1xxxxxxxx	e.g. 480
Use of a free bit (e.g. 13) during operation	0000010001111111 <u>+0010000000000000</u> 0010010001111111	47F <u>+2000</u> 247F
Cancelling "Lock switching-on"	"15 Lock switching-on" 0000010001111110 0000010001111111	e.g.: 47E 47F

04/2013

8 P02 517 EN.00/00

Simplified state machine

For standard control with the commands:

- Start / Stop
- OFF 2
- OFF 3
- Reset of a detected fault

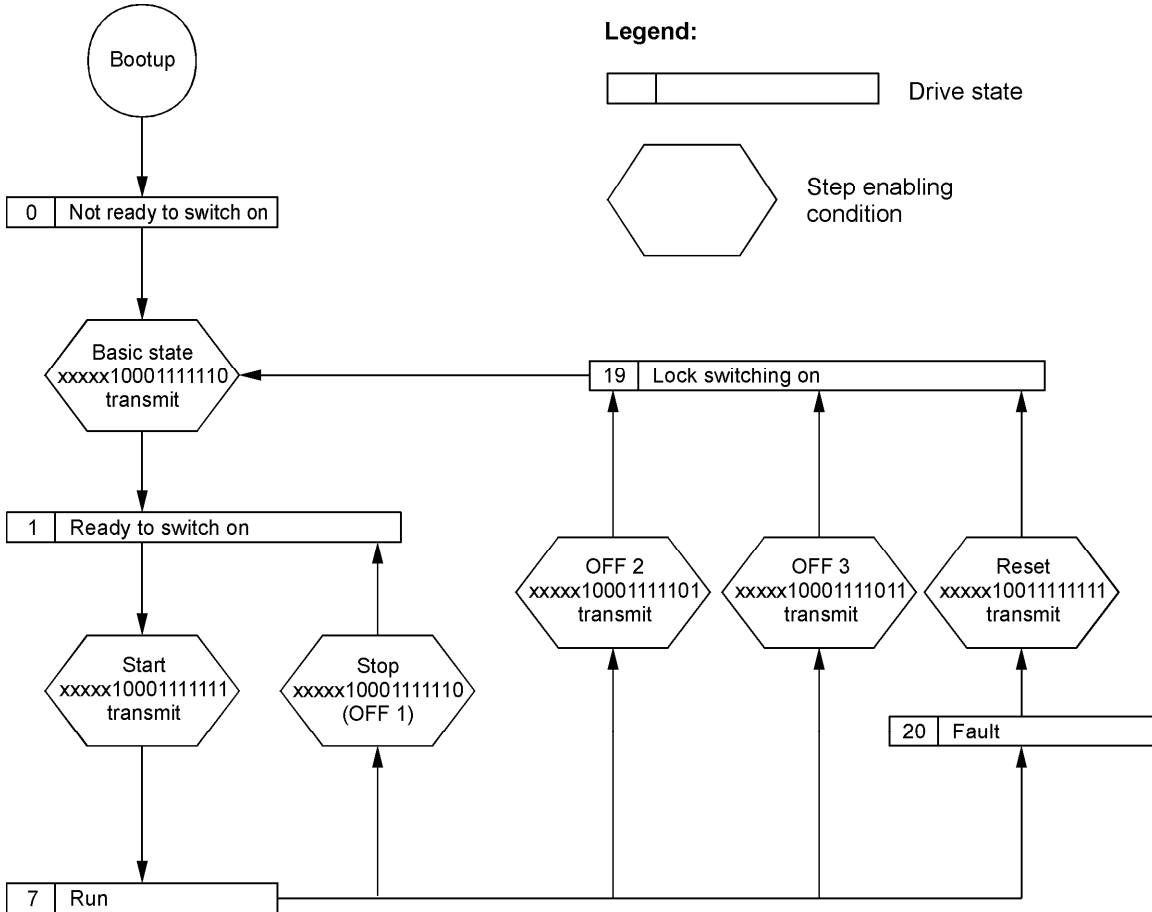

04/2013
8 P02 517 EN.00/00

NOTICE

The commands OFF 2, OFF 3 as well as a detected fault which has been reset result in drive state "Lock switching-on" !

In order to reach drive state "Run" it is necessary to send the basic state (bit 0 = 0, bit 1, 2 = 1) before transmitting the start command (bit 0 = 1).

NOTICE

After connecting the mains (bootup of the drive) the basic state (bit 0 = 0, bit 1, 2 =1) must be provided in order to reach drive state "Ready to switch on".

State machine Profidrive

At the Active Front End the Profidrive profile has to be selected with parameter 4.6.04 Bus profile.

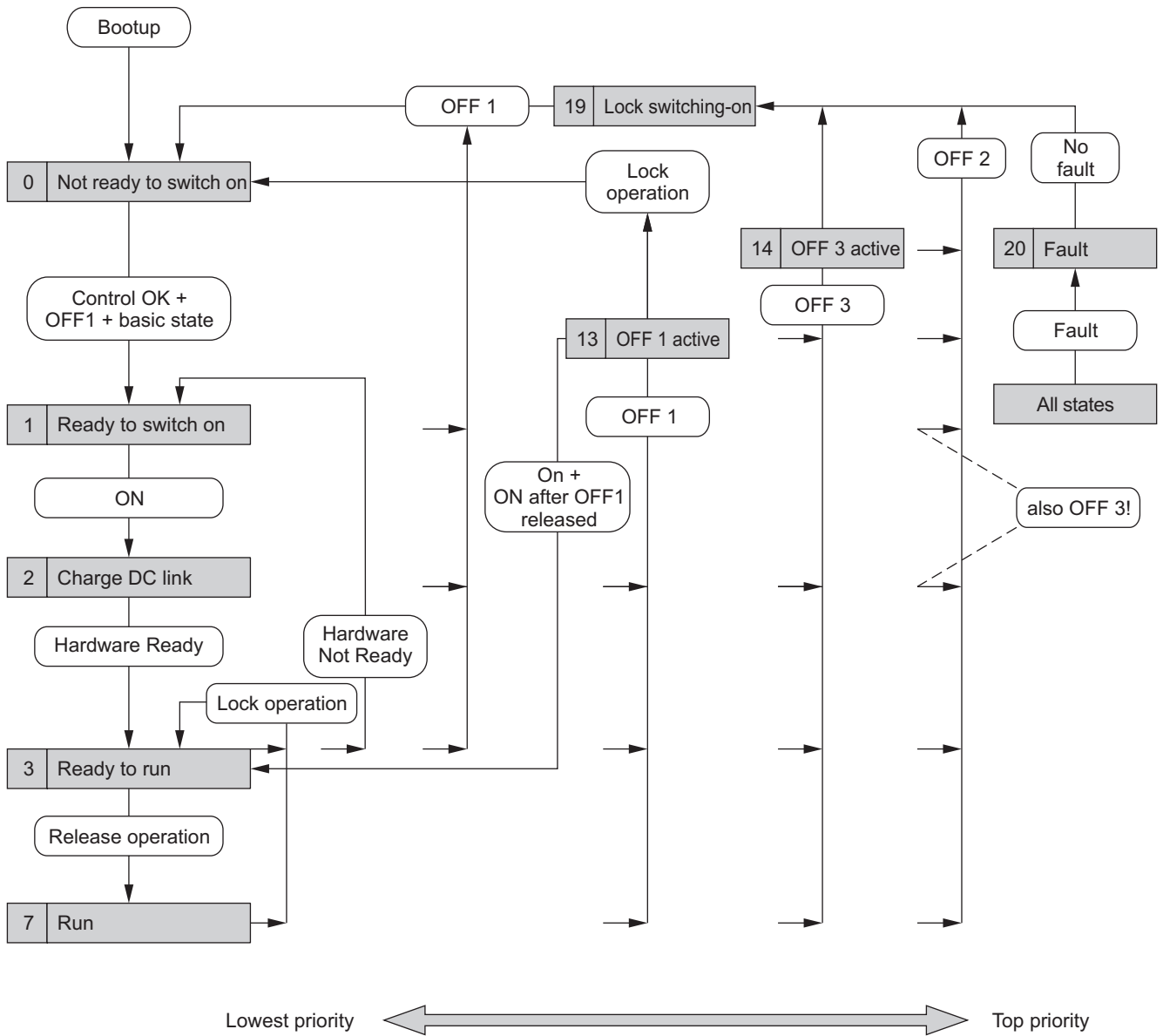

04/2013
8 P02 517 EN.00/00

Status word

Assignment

Bit 15	–	
Bit 14	–	
Bit 13	–	
Bit 12	–	
Bit 11	–	
Bit 10	–	–
Bit 9	Control requested	No control authority requested
Bit 8	–	–
Bit 7	Alarm	No alarm
Bit 6	Lock switching-on	No lock switching-on
Bit 5	no OFF 3	OFF 3
Bit 4	no OFF 2	OFF 2
Bit 3	Fault	Failure-free
Bit 2	Operation released	Operation locked
Bit 1	Ready to run	Not ready to run
Bit 0	Ready to switch on	Not ready to switch on
High = 1		Low = 0

04/2013

8 P02 517 EN.00/00

Listing of the typical drive states	Status word bits										
	10	9	8	7	6	5	4	3	2	1	0
0 .. Not ready to switch on	x	1	x	x	0	x	x	0	0	0	0
1 .. Ready to switch on	x	1	x	x	0	x	1	0	0	0	1
3 .. Ready to run	x	1	x	x	0	x	1	0	0	1	1
7 .. Run	x	1	x	x	0	1	1	0	1	1	1
19 .. Lock switching on	x	1	x	x	1	x	x	0	0	0	0
20 .. Fault	x	1	x	x	0	x	x	1	0	0	0

- 0 .. Bit state zero
- 1 .. Bit state one
- x .. Bit state is undefined

Description of status word bits

Bit	Value	Meaning	Comment
0	1	Ready to switch on	The drive state is "1 .. <i>Ready to switch on</i> ". The Active Front End is locked.
	0	Not ready to switch on	The drive state is "0 .. <i>Not ready to switch on</i> " or "19 .. <i>Lock switching-on</i> ".
1	1	Ready to run	The drive state is "3 .. <i>Ready to run</i> ". That means that there is voltage on the power part and there are no detected faults. But the Active Front End is still locked.
	0	Not ready to run	
2	1	Operation released	The drive state is "7 .. <i>Run</i> ", "13 .. <i>OFF 1 active</i> " or "14 .. <i>OFF 3 active</i> ". The Active Front End is operating with impulse enable and there is voltage on the output terminals.
	0	Operation locked	
3	1	Fault	The drive is not in operation due to a detected fault. The drive state is "20 .. <i>Fault</i> ". After successful correction and reset of the detected fault the drive state changes to "19 .. <i>Lock switching-on</i> ".
	0	Failure-free	
4	1	no OFF 2	
	0	OFF 2	An OFF 2 command is given.
5	1	no OFF 3	
	0	OFF 3	An OFF 3 command is given.
6	1	Lock switching-on	The inverter has drive state "19 .. <i>Lock switching-on</i> ". This state is a result of the commands OFF 2 and OFF 3 as well as after successful resetting of a detected fault. This drive state is canceled by means of bit 0 STW = 0.
	0	No lock switching-on	
7	1	Alarm	There is an alarm message, resetting is not required.
	0	No alarm	
8	x	Not used	
9	1	Control requested	When the Active Front End is parameterized for bus operation by means of parameter 4.6.01 (control via bus), the Active Front End asks the DP master for assumption of control after mains connection or connecting an external 24 V buffer voltage. As long as the master does not assume control, an alarm message (ZTW bit 7) is given.
	0	No bus operation	If the Active Front End is disconnected from the bus communication because of switching to panel mode (key on the keypad), bit 9 is reset to zero. <ul style="list-style-type: none"> – If the master does not send "Control OK" (STW bit10 = 0), an alarm message is set. – When the drive is switched to remote mode = bus operation again, the automation system has to answer with "Control OK" within 2 seconds. Otherwise the drive is switched back to panel mode automatically.
10	x	Not used	

04/2013

8 P02 517 EN.00/00

Main actual value (Auxiliary actual values)

In the PDO1 three actual values (each 16 bit) are available, in PDO2 one actual value. The meaning of the individual actual values is defined by parameterization of the Active Front End AFE using the operating panel.

The actual values can be used as internal actual values of the Active Infeed Converter like e.g. actual value of current, power a.s.o. (according to the analog outputs of the AFE).

The actual values are linear scaled values with 16 bit display.

That is 0 % = 0 (0 hex), 100 % = 2^{14} (4000 hex)

Therefrom a presentable data range of -200...+200 % with a resolution of 2^{-14} (0.0061 %) results.

%	Binary	Hexadecimal	Decimal
199.9939	01111111 11111111	7FFF	32767
100.000	01000000 00000000	4000	16384
0.0061	00000000 00000001	0001	1
0.000	00000000 00000000	0000	0
-0.0061	11111111 11111111	FFFF	-1
-100.000	11000000 00000000	C000	-16384
-200.000	10000000 00000000	8000	-32768

The scaling of the actual values is done by parameterization in parameter group 4.6. The scaling of the individual actual values is fixed for each output value. See parameter group 4.6.

04/2013

8 P02 517 EN.00/00

Parameterization

04/2013

8 P02 517 EN.00/00

General

Using the 03hex Read Holding Register and 06 Write Single Register Modbus services, each parameter in the Active Infeed Converter AIC can be read or written via the bus.

The request initiated by the master (read / write) is transferred to the Active Infeed Converter via the Modbus. The Active Infeed Converter processes the request and sends a corresponding response.

Inside the device, the parameterization is processed as a background task. There, the parameter requests are processed in a time-optimized manner, i.e. a request is accepted and, at the same time, a response is provided for retrieval (typ. 10...50 ms).

Request and response telegram are of following data type:

Read parameter value

Request telegram Master → Altivar AFE

Slave address	Request	Parameter address		Number of parameters to be read		CRC 16	
	3 hex	Hi	Lo	Hi	Lo	Lo	Hi
1 byte	1 byte	2 bytes		2 bytes		2 bytes	

Response telegram Altivar AFE → Master

Slave address	Response	Number of read bytes	Parameter value 1		...	Parameter value X		CRC 16	
	03 hex		Hi	Lo	...	Hi	Lo	Lo	Hi
1 byte	1 byte	1 byte	2 bytes			2 bytes		2 bytes	

Write parameter value

Request telegram Master → Altivar AFE

Slave address	Request	Parameter address		Parameter value		CRC 16	
	06 hex	Hi	Lo	Hi	Lo	Lo	Hi
1 byte	1 byte	2 bytes		2 bytes		2 bytes	

Response telegram Altivar AFE → Master

Slave address	Response	Parameter address		Parameter value		CRC 16	
	06 hex	Hi	Lo	Hi	Lo	Lo	Hi
1 byte	1 byte	2 bytes		2 bytes		2 bytes	

The individual parameters are accessed via their internal logical addresses. Addresses are valid in the range of 0...2047 (11 bits) and they are mentioned in the parameter list which is provided in the appendix. The address is used in the request telegram as well as in the response telegram.

When the writing request has been executed successfully, the transmitted parameter value appears in the response telegram and the original request code as echo.

In case of requests that can not be executed, a diagnostic telegram is sent to the master. It contains the original request code, but bit 7 is set to "high" as an "error flag" (request + 80 hex). In the diagnostic code, details regarding the existing status can be found.

Structure of the diagnostic telegram

Slave Address	Response code	Diagnostic code	CRC 16	
	80 + request code		Lo	Hi
1 byte	1 byte	1 byte	2 bytes	

Diagnostic code	Description
00	No fault detected
01	Unknown request code
02	Inadmissible logical or physical address
03	Incorrect size of data (byte, word) or incorrect number of data
04	Request cannot be executed because: <ul style="list-style-type: none"> – Parameter is of type "actual value" – Parameter cannot be changed during operation – Parameter cannot be changed due to double assignment – The parameterizing station (6.1.03) is not set to "Modbus"
05	Length of request incorrect
06	Access not allowed

Rules for processing of requests / responses

- The master makes a request and has to wait for the response telegram of the respective slave before it can formulate a new request.
- The master has to check the response to a request made dependent on the response code.
 - In case of a positive response code (request = response)
 - Evaluation of the parameter number
 - Evaluation of the parameter value
 - In case of a negative response code (request +80hex)
 - Evaluation of the diagnostic code
- Requests or responses have to be completely transferred in one telegram. Combined requests are not possible.
- In case of responses which include actual values, the Active Infeed Converter replies the actual value when repeating the response telegrams.
- For write requests, the value which is transmitted in the response must be evaluated (the request is canceled if the value remains the same or if a trip is detected).
- After changing a parameter a storage command has to be sent in order to save the data in the event of a voltage interruption. The storage command takes place when writing value 1 to the logical address 0028 hex / 40 dec.

Examples

Reading of the operating hours (parameter 1.2.05, address 009E hex / 158 dec)

Request telegram Master → Altivar AFE

Slave	Code	Para. address		Number of parameters		CRC	
0A	03	00	9E	00	01	9F	E4

Response telegram Altivar AFE → Master

Slave	Code	Number of bytes	Param. value		CRC	
0A	03	02	01	FE	95	9D

Parameter value 01FE hex = 510 dec

Operating hours = 510 * 1 = 510 h

Programming of the parameterizing station on Modbus (6.1.03 = setting 2, address 047A hex, 1146 dec)

Request telegram Master → Altivar AFE

Slave	Code	Para. address		Para. value		CRC	
0A	06	04	7A	00	02	99	29

Response telegram Altivar AFE → Master

Slave	Code	Para. address		Para. value		CRC	
0A	06	04	7A	00	02	99	29

NOTICE

It is necessary to set parameter 6.1.03 "Parametrising station" to setting "2 .. Modbus" in order to be qualified for adjusting other parameters via Modbus.

Programming of relay output R1 to trip (3.4.01 = setting "3 .. Trip", addr. 031D hex, 797 dec)

Request telegram Master → Altivar AFE

Slave	Code	Para. address		Para. value		CRC	
0A	06	03	1D	00	03	F2	58

Response telegram Altivar AFE → Master (in case of accepted request)

Slave	Code	Para. address		Para. value		CRC	
0A	06	03	1D	00	03	F2	58

Response telegram Altivar AFE → Master (in case of non-executable request)

Slave	Response code	Diagnostic code	CRC 16	
0A	86	04	61	32

Response code 86 = Not allowed parameterization (request 06+80 = 86)

Diagnostic code = 04 parameter value cannot be written (Adjusting parameters is only permitted during impulse inhibit. The parameterizing station "Modbus" is not set.)

Adjustment of an analog value (3.3.04 "AO1 max. value" = 150 %, address 0311 hex, 785 dec)

Request telegram Master → Altivar AFE

Slave	Code	Para. address		Para. value		CRC	
0A	06	03	11	3A	98	FA	CB

Parameter value: for transferred value = real value * factor

150.00% * 100 = 15000 (15000 dec / 3A98 hex)

Response telegram Altivar AFE → Master

Slave	Code	Para. address		Para. value		CRC	
0A	06	03	11	3A	98	FA	CB

04/2013

8 P02 517 EN.00/00

Reading of drive reference 1.3.01, address 000B hex, 11 dec

The drive reference is a parameter of type text. It is to be read in ASCII-coded form.

Corresponding to the expected length of text the start address and a certain number of ensuing parameters has to be read. See the parameter list in the appendix.

Request telegram Master → Altivar AFE

Slave	Code	Para. address		Number of parameters		CRC	
						B5	34
0A	03	00	0B	00	08	B5	34

Response telegram Altivar AFE → Master

Slave	Code	Number of bytes	Para. value 1		Para. value 2		Para. value 3		Para. value 4		---	
			41	49	43	2D	34	56	36	37		
0A	03	10	41	49	43	2D	34	56	36	37	---	
---			Para. value 5		Para. value 6		Para. value 7		Para. value 8		CRC	---
---			35	20	00	00	00	00	00	00	Lo Hi	---

Evaluation of the parameter values:

When you string the characters decoded with ASCII together, you get the drive reference.

AIC 4V675_

(in the case of this type, only 10 characters are used)

ASCII code table

ISO / IEC 10 367

Basic G0 Set

Latin Alphabet No. 1 supplementary set

hex	Char	hex	Char	hex	Char	hex	Char	hex	Char	hex	Char
20	Space	40	@	60	`	A1	ı	C1	Á	E1	á
21	!	41	A	61	a	A2	ç	C2	Â	E2	â
22	"	42	B	62	b	A3	£	C3	Ã	E3	ã
23	§	43	C	63	c	A4	¤	C4	Ä	E4	ä
24	\$	44	D	64	d	A5	¥	C5	Å	E5	å
25	%	45	E	65	e	A6	ı	C6	Æ	E6	æ
26	&	46	F	66	f	A7	§	C7	Ç	E7	ç
27	'	47	G	67	g	A8	¨	C8	È	E8	è
28	(48	H	68	h	A9	©	C9	É	E9	é
29)	49	I	69	i	AA	ª	CA	Ê	EA	ê
2A	*	4A	J	6A	j	AB	«	CB	Ë	EB	ë
2B	+	4B	K	6B	k	AC	¬	CC	Ì	EC	ì
2C	,	4C	L	6C	l	AD		CD	Í	ED	í
2D	-	4D	M	6D	m	AE	®	CE	Î	EE	î
2E	.	4E	N	6E	n	AF	¯	CF	Ï	EF	ï
2F	/	4F	O	6F	o	B0	°	D0	Ð	F0	ð
30	0	50	P	70	p	B1	±	D1	Ñ	F1	ñ
31	1	51	Q	71	q	B2	²	D2	Ò	F2	ò
32	2	52	R	72	r	B3	³	D3	Ó	F3	ó
33	3	53	S	73	s	B4	´	D4	Ô	F4	ô
34	4	54	T	74	t	B5	µ	D5	Õ	F5	õ
35	5	55	U	75	u	B6	¶	D6	Ö	F6	ö
36	6	56	V	76	v	B7	·	D7	×	F7	÷
37	7	57	W	77	w	B8	¸	D8	Ø	F8	ø
38	8	58	X	78	x	B9	¹	D9	Ù	F9	ù
39	9	59	Y	79	y	BA	º	DA	Ú	FA	ú
3A	:	5A	Z	7A	z	BB	»	DB	Û	FB	û
3B	;	5B	[7B	{	BC	¼	DC	Ü	FC	ü
3C	<	5C	\	7C		BD	½	DD	Ý	FD	ý
3D	=	5D]	7D	}	BE	¾	DE	Þ	FE	þ
3E	>	5E	^	7E	~	BF	¿	DF	ß	FF	ÿ
3F	?	5F	_	7F	DEL	C0	À	E0	à	0	\n

04/2013

8 P02 517 EN.00/00

AFE settings

04/2013

8 P02 517 EN.00/00

4.6



Bus settings

Settings of the serial communication properties

General fieldbus settings

Parameter group 4.6 Bus settings is used for configuration of the fieldbus connections which are possible with the Active Front End. The two fieldbus connections CANopen and Modbus are available as standard.

According to the used bus which is selected with parameter 4.6.01 only parameters for this bus are displayed in parameter group 4.6.

4.6.01	Bus selection			0 .. No bus
0 ...No bus 1 ...Modbus 2 ...CANopen				

The desired fieldbus system is activated by means of parameter 4.6.01 Bus selection. The activation influences the principle data exchange between the bus subscribers in respect of the transmitted process data (reference / actual values) and the parameterization service.

In order to use the bus control word of the respective bus profile for the control of the Active Front End, the control source (parameter 2.2.01) has to be set to "Fieldbus control".

See also parameter group 2.2 of the Description of functions for the Active Front End.

4.6.02	Control requested			0 .. Not active
0 ...Not active 1 ...Active				

In order to recognize a communication problem at the serial fieldbus interface, two different monitoring routines are available.

Watch dog timing



The watch dog timing checks the fieldbus interface for a cyclical signal of the active bus master or scanner and therefrom it is a check of the bus hardware (cable break, malfunction of the master component, ...). The monitoring time depends on the existing network configuration like the number of subscribers, set baud rate a.s.o.. It is automatically transmitted from the master to the slave by means of the parameterization telegram or it has to be set at the Active Front End.



Loss of control

In contrast to the watch dog timing the control monitoring checks the data content of the serial data traffic. If a malfunction occurs at the fieldbus master or its respective PLC, all outgoing data are set to zero (Fail Save Mode). Therefore, the slave receives a telegram (with data content zero) periodically which helps to prevent the triggering of the watch dog timing.

In order to recognize this state and to take suitable measures, a monitoring of control can be activated with parameter 4.6.02 (typical for Profibus DP).

When parameter 4.6.02 Control requested is set to "1 .. Active" the Active Front End monitors bit 10 of the control word. If this bit equals state "Low", the trip "loss of control" is detected.



4.6.03	Bus error reaction				4 .. -Δt- Trip
4 ...-Δt- Trip 5 ...-Δt- Alarm					

4.6.04	Bus profile				1 .. DriveCom
1 ...DriveCom 2 ...Profidrive					



Due to the bus profile a standardised communication is possible. The communication profile to be used can be selected with parameter 4.6.04.



NOTICE					
When the Active Front End is operated with a Profibus card, parameter 4.6.04 has to be set to "2 .. Profidrive".					

Modbus settings

4.6.10	Modbus address				0
0...247					

Address of the Modbus subscriber. When the address is set to 0, the Modbus server is deactivated internally. The address 0 is used by the Modbus master for broadcast telegrams.

4.6.11	Modbus baud rate				32 .. 19200 Baud
24...4800 Baud 28...9600 Baud 32...19200 Baud 36...38400 Baud 40...57600 Baud					

4.6.12	Modbus format				3 .. 8E1
2 ...8O1 3 ...8E1 4 ...8N1 5 ...8N2					



Setting	Start bit	Data bits	Parity bit	Stop bit	Bit / byte
8O1	1	8	Odd	1	11
8E1	1	8	Even	1	11
8N1	1	8	No	1	10
8N2	1	8	No	2	11

Configuration of the fieldbus actual values

Corresponding to the configured telegram length there are four actual values available in addition to the digital status word.

Following process sizes can be transmitted as actual values:

Process size	Value	Unit	Scaling
1 .. load VSD	100.0	%	Nominal current AFE
2 .. Mains current	100.0	%	100 % = Nominal current AFE
3 .. Power	100.0	%	100 % = Nominal power
4 .. Power	100.0	%	100 % = Nominal power
5 .. Line filter voltage	100.0	%	100 % = Adjusted mains voltage
6 .. DC voltage	100.0	%	100 % = 1000 V
7 .. kWh meter mot.	1.0	kWh	Parameter 1.2.02
8 .. MWh meter mot.	1	MWh	Parameter 1.2.01
9 .. kWh meter gen.	1.0	kWh	Parameter 1.2.04
10 .. MWh meter gen.	1	MWh	Parameter 1.2.03
11 .. Act. Error Code	–	Integer	See table alarm index given in the appendix
12 .. Act. alarm Code	–	Integer	See table alarm index given in the appendix

4.6.40	Act. value1 selection				7 .. kWh meter mot.
	0 ...Not used				
	1 ...load VSD	5... Line filter voltage		10.. MWh meter gen.	
	2 ...Mains current	6... DC voltage		11.. Act. Error Code	
	3 ...Power	7...kWh meter mot.		12.. Act. alarm Code	
	4 ... Power	8...MWh meter mot.			
		9...kWh meter gen.			

Selection of the size which should be transmitted at bus actual value 1.

4.6.41	Act. value1 min. value -300...300 %				0 %
4.6.42	Act. value1 max. value -300...300 %				100 %

The two parameters 4.6.41 "Act. value1 min. value" and 4.6.42 "Act. value1 max. value" are used for linear scaling of the transmitted bus actual value. 4.6.41 assigns the minimum value to the actual value point 0 % (0 dec = 0000 hex), 4.6.42 assigns the maximum value of a process size to the actual value point 100 % (16384 dec = 4000 hex).

The scaling of the process size and its unit can be seen from the table above.

Settings example for bus actual value 1

Process size	Scaling	4.6.41 "Act. value1 min. value"	4.6.42 "Act. value1 max. value"	Scaling of the output signal
3 .. Power	100 % = Nominal power AFE (e.g. 120 kW)	0 %	100 %	4000 hex (16384 dec) at 100 % Nominal power AFE (max. presentable range = 200 %)

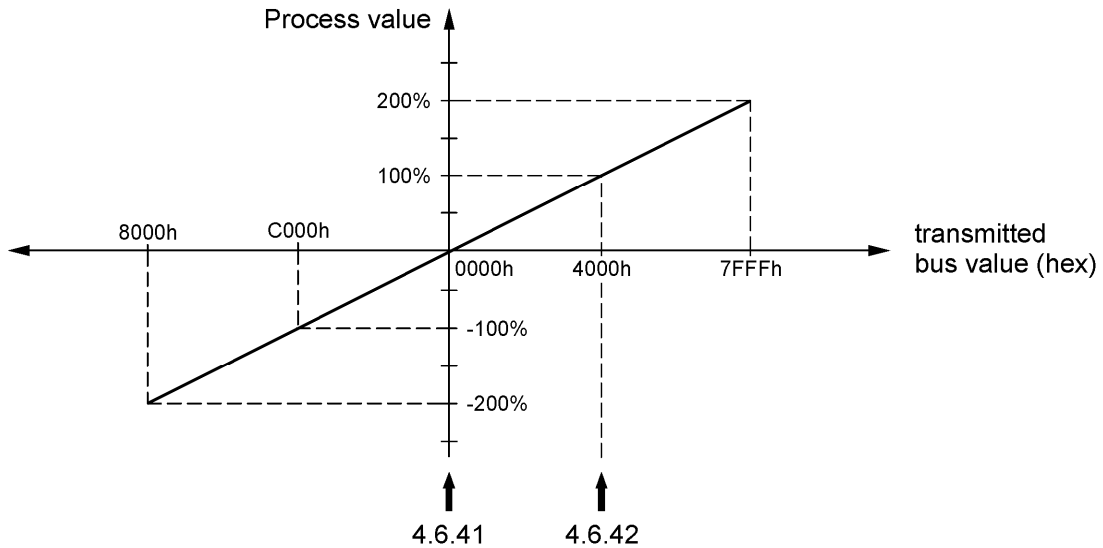

04/2013
8 P02 517 EN.00/00

4.6.43	Act. value1 filter-time 0...30 s				0 s
--------	-------------------------------------	--	--	--	-----

During the measurement of dynamically changing values, such as current or load, it may be a good idea to filter the actual value which should be transmitted already in the Active Front End. The measurement value can be stabilized before transmission by setting an appropriate filter time at the output filter.

At setting 0.0 seconds the filter is deactivated.

4.6.44	Act. value2 selection				8 .. MWh meter mot.
4.6.45	Act. value2 min. value				0 %
4.6.46	Act. value2 max. value				100 %
4.6.47	Act. value2 filter-time				0 s

4.6.48	Act. value3 selection				9 .. kWh meter gen.
4.6.49	Act. value3 min. value				0 %
4.6.50	Act. value3 max. value				100 %
4.6.51	Act. value3 filter-time				0 s

4.6.52	Act. value4 selection				10 .. MWh meter gen.
4.6.53	Act. value4 min. value				0 %
4.6.54	Act. value4 max. value				100 %
4.6.55	Act. value4 filter-time				0 s





















The settings of the bus reference values 2...4 are logical identical with those of bus reference value 1 (see parameters 4.6.40...4.6.43).

Bus - Diagnostics





















04/2013

8 P02 517 EN.00/00

Diagnostics of the "Bus raw data"

4.6.100	PRx 01				hex
4.6.101	PRx 02				hex
4.6.102	PRx 03				hex
4.6.103	PRx 04				hex
4.6.104	PRx 05				hex
4.6.105	PRx 06				hex
4.6.106	PRx 07				hex
4.6.107	PRx 08				hex
4.6.108	PRx 09				hex
4.6.109	PRx 10				hex

Presentation of the incoming data words 1...10 at the bus.

4.6.110	PTx 01				hex
4.6.111	PTx 02				hex
4.6.112	PTx 03				hex
4.6.113	PTx 04				hex
4.6.114	PTx 05				hex
4.6.115	PTx 06				hex
4.6.116	PTx 07				hex
4.6.117	PTx 08				hex
4.6.118	PTx 09				hex
4.6.119	PTx 10				hex

Presentation of the outgoing data words 1...10 at the bus.

Bus coupling

04/2013

8 P02 517 EN.00/00

Design

The typical "Bus operation" (Active Front End units are controlled via fieldbus) is available.
The whole control and diagnostics of the Active Front End is carried out by means of the bus coupling.
The possibility to implement conventional control elements is not used.

NOTICE

In order to address an Active Front End via fieldbus also during mains cut-off (disconnecting switch, ...) the Active Front End AFE has to be supplied with an external 24 V buffer voltage.

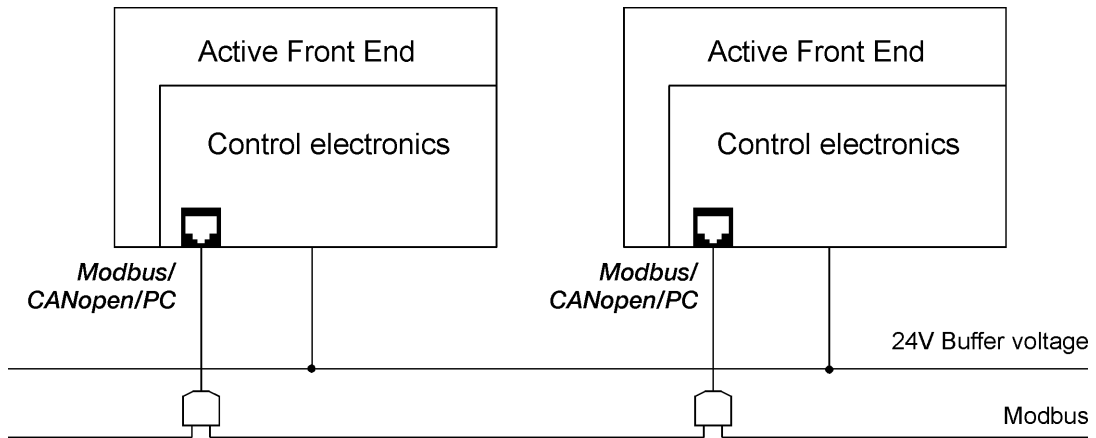

04/2013

8 P02 517 EN.00/00

04/2013

8 P02 517 EN.00/00

List of parameters

Parameter name	Log. address		Type	Adjust-ability	Factor	Setting range		Unit
	dec	hex				min	max	
1.2 Counter								
Operating hours meter								
1.2.01 MWh meter mot.	163	A3			1			MWh
1.2.02 kWh meter mot.	164	A4			10			kWh
1.2.03 MWh meter gen.	165	A5			1			MWh
1.2.04 kWh meter gen.	166	A6			10			kWh
1.2.05 Operating hours AFE	158	9E			1			h
1.2.06 Interval operating hours	470	1D6			1	0	60000	h
1.2.07 Interval counter	159	9F			1			h
1.2.08 Clear interval counter	162	A2						
1.3 Device identification								
Identification of the device								
1.3.01 Device type AFE	11	B	txt					
Ensuing parameter	12	C	txt					
Ensuing parameter	13	D	txt					
Ensuing parameter	14	E	txt					
Ensuing parameter	15	F	txt					
Ensuing parameter	16	10	txt					
Ensuing parameter	17	11	txt					
Ensuing parameter	18	12	txt					
1.3.02 Nominal power AFE	2341	925			1			W
1.3.03 Nominal current AFE	296	128			10			A
1.3.04 Nominal voltage AFE	297	129						
1.3.05 Serial number AFE	19	13			1			
1.3.06 Facility description	23	17	txt					
Ensuing parameter	24	18	txt					
Ensuing parameter	25	19	txt					
Ensuing parameter	26	1A	txt					
Ensuing parameter	27	1B	txt					
Ensuing parameter	28	1C	txt					
Ensuing parameter	29	1D	txt					
Ensuing parameter	30	1E	txt					
1.3.07 APP software AFE	31	1F	txt					
Ensuing parameter	32	20	txt					
Ensuing parameter	33	21	txt					
Ensuing parameter	34	22	txt					
Ensuing parameter	35	23	txt					
Ensuing parameter	36	24	txt					
Ensuing parameter	37	25	txt					
Ensuing parameter	38	26	txt					
1.3.08 Service notice	1993	7C9	txt					
Ensuing parameter	1994	7CA	txt					
Ensuing parameter	1995	7CB	txt					
Ensuing parameter	1996	7CC	txt					
Ensuing parameter	1997	7CD	txt					
Ensuing parameter	1998	7CE	txt					
Ensuing parameter	1999	7CF	txt					
Ensuing parameter	2000	7D0	txt					
Ensuing parameter	2001	7D1	txt					
Ensuing parameter	2002	7D2	txt					
Ensuing parameter	2003	7D3	txt					
Ensuing parameter	2004	7D4	txt					

04/2013

8 P02 517 EN.00/00

Parameter name	Log. address		Type	Adjust-ability	Factor	Setting range		Unit	
	dec	hex				min	max		
1.4 Display configuration									
Configuration of the display									
1.4.01	Selection upper field	472	1D8						
1.4.03	Selection lower field	474	1DA						
1.5 Language selection									
Language selection									
1.5.01	Language selection	477	1DD						
2.1 AFE settings									
AFE settings									
2.1.01	Mains voltage	495	1EF						
Control logic									
2.1.02	Parallel operation	1687	697						
AFE settings									
2.1.10	Apparent power ref.value	1692	69C			1	0	32767	VA
2.1.11	Reactive power factor	1693	69D			1	-100	100	%
2.2 Control commands									
Control logic									
2.2.01	Control source	1677	68D						
2.3 Operating panel									
Panel operation									
2.3.01	Operat.panel stop button	949	3B5						
2.3.02	Operat.panel monitoring	2962	B92						
2.4 External fault									
External fault									
2.4.01	Ext. fault monitor	911	38F						
2.4.02	Ext. fault response	912	390						
2.4.03	Start delay time	913	391			10	0	600	s
2.4.04	Time Δt	914	392			10	0	300	s
2.5 Fault configuration									
Behaviour in case of faults									
2.5.01	Autoreset	891	37B						
2.5.02	Autoreset selection	892	37C	0110					
2.5.03	Alarm	1676	68C	0110					
3.2 Logic inputs									
Logic inputs									
3.2.01	LI inversion	2703	A8F	0110					
Service parameter									
3.2.02	LI at bus mode active	781	30D	0110					
3.3 Analog output									
Analog output									
3.3.01	AO1 selection	782	30E						
3.3.02	AO1 level	783	30F						
3.3.03	AO1 min. value	784	310			100	-300	300	%
3.3.04	AO1 max. value	785	311			100	-300	300	%
3.4 Logic outputs									
Logic outputs									
3.4.01	R1 selection	797	31D						
3.4.02	R3 selection	799	31F						
3.4.03	LO1 selection	800	320						
3.4.04	LO2 selection	801	321						
3.4.05	LO inversion	805	325	0110					
3.4.06	Overload level	1680	690			1	0	120	%

Parameter name	Log. address		Type	Adjust-ability	Factor	Setting range		Unit	
	dec	hex				min	max		
4.1 Process protection									
Limitations									
4.1.01	I max 1 generator	1672	688			1	10	120	%
4.1.02	I max 2 generator	1673	689			1	10	120	%
4.3 Emergency operation									
Emergency operation									
4.3.01	Enable emergency op.	894	37E						
4.3.02	Emergency op. active	276	114						
4.6 Bus settings									
Fieldbus configuration									
4.6.01	Bus selection	1301	515						
4.6.02	Control requested	1302	516						
4.6.03	Bus error reaction	1303	517						
4.6.04	Bus profile	2757	AC5						
4.6.10	Modbus address	1305	519			1	0	247	
4.6.11	Modbus baud rate	1306	51A						
4.6.12	Modbus format	1307	51B						
4.6.20	CANopen address	1319	527			1	0	127	
4.6.21	CANopen baud rate	1320	528						
4.6.22	CANopen state	206	CE						
4.6.23	CANopen error register	207	CF	0110					
4.6.24	CANopen Rx error count	204	CC			1			
4.6.25	CANopen Tx error count	205	CD			1			
4.6.30	DP slave address	1321	529			1			
4.6.31	DP baud rate	208	D0						
4.6.32	Slave state	209	D1						
4.6.33	Master settings	210	D2	0110					
4.6.34	DP diagnostic buffer 1	215	D7			1			hex
4.6.35	DP diagnostic buffer 2	216	D8			1			hex
4.6.40	Act. value1 selection	1361	551						
4.6.41	Act. value1 min. value	1362	552			100	-300	300	%
4.6.42	Act. value1 max. value	1363	553			100	-300	300	%
4.6.43	Act. value1 filter-time	1364	554			100	0	30	s
4.6.44	Act. value2 selection	1365	555						
4.6.45	Act. value2 min. value	1366	556			100	-300	300	%
4.6.46	Act. value2 max. value	1367	557			100	-300	300	%
4.6.47	Act. value2 filter-time	1368	558			100	0	30	s
4.6.48	Act. value3 selection	1369	559						
4.6.49	Act. value3 min. value	1370	55A			100	-300	300	%
4.6.50	Act. value3 max. value	1371	55B			100	-300	300	%
4.6.51	Act. value3 filter-time	1372	55C			100	0	30	s
4.6.52	Act. value4 selection	1373	55D						
4.6.53	Act. value4 min. value	1374	55E			100	-300	300	%
4.6.54	Act. value4 max. value	1375	55F			100	-300	300	%
4.6.55	Act. value4 filter-time	1376	560			100	0	30	s
Diagnosis									
4.6.100	PRx 01	230	E6			1			hex
4.6.101	PRx 02	231	E7			1			hex
4.6.102	PRx 03	232	E8			1			hex
4.6.103	PRx 04	233	E9			1			hex
4.6.104	PRx 05	234	EA			1			hex
4.6.105	PRx 06	235	EB			1			hex
4.6.106	PRx 07	236	EC			1			hex
4.6.107	PRx 08	237	ED			1			hex

Parameter name	Log. address		Type	Adjust-ability	Factor	Setting range		Unit
	dec	hex				min	max	
4.6.108 PRx 09	238	EE			1			hex
4.6.109 PRx 10	239	EF			1			hex
4.6.110 PTx 01	250	FA			1			hex
4.6.111 PTx 02	251	FB			1			hex
4.6.112 PTx 03	252	FC			1			hex
4.6.113 PTx 04	253	FD			1			hex
4.6.114 PTx 05	254	FE			1			hex
4.6.115 PTx 06	255	FF			1			hex
4.6.116 PTx 07	256	100			1			hex
4.6.117 PTx 08	257	101			1			hex
4.6.118 PTx 09	258	102			1			hex
4.6.119 PTx 10	259	103			1			hex

5.1 Test function

Test routines

5.1.01 Software reset	1095	447						
5.1.02 Simulation mode	1094	446						

5.2 Fault memory

Fault memory

5.2.01 Number of faults AFE	298	12A			1			
5.2.02 Review AFE	1096	448						
5.2.03 Fault number AFE	299	12B			1			
5.2.04 Fault cause AFE	300	12C						
5.2.05 Operating hours AFE	301	12D			1			h
5.2.06 Min / sec	302	12E			100			m:s
5.2.07 Energy direction AFE	1685	695						
5.2.08 Line filter voltage AFE	1686	696			1			V
5.2.09 Mains current AFE	305	131			1			A
5.2.10 DC voltage AFE	306	132			1			V
5.2.11 AFE load	307	133			1			%
5.2.12 Control mode AFE	308	134						
5.2.13 Operating state AFE	309	135						
5.2.14 Alarm message AFE	310	136						
5.2.15 Device state AFE	312	138						
5.2.16 Bus STW AFE	311	137	0110					
5.2.17 Bus ZTW AFE	313	139	0110					

5.3 State

State logic inputs

5.3.01 LI state basic device	314	13A	0110					
5.3.02 LI state option	315	13B	0110					
5.3.03 LO state basic device	317	13D	0110					
5.3.04 LO state option	318	13E	0110					

6.1 Code

Security settings

6.1.01 Code AFE	1144	478			1	0	9999	
6.1.02 Code value AFE	1145	479			1	0	9999	
6.1.03 Parametrising station	1146	47A						
6.1.04 Lock	1147	47B						
6.1.05 Service code AFE	1148	47C			1	0	59999	

Device messages

Alarm/Info messages

Message	Alarm index (dec.)	Description
Emergency op. active	02	The Active Front End is switched over to the status "Emergency operation" via a logic input command. See parameter 4.3.02.
External fault	03	An external fault is signaled via a logic input command (see 2.4.01...2.4.04). It is processed as an alarm message corresponding to the setting of 2.4.02 Ext. fault response.
Undervoltage	05	There is an undervoltage situation.
Bus error	09	According to the setting of 4.6.03 Bus error reaction a detected fault of the bus caused by exceeded runtime or a loss of control leads to an alarm message.
Overload	21	The overload level set with parameter 3.4.06 has been exceeded.
Service AFE	26	The operating hours counter (1.2.05) for the power part of the device (device is supplied with mains voltage) has exceeded the set time interval (1.2.06).
Simulation active	28	The Simulation mode (5.1.02) is activated.
Download active	29	The PC program executes a parameter download. After transmission it is necessary to confirm or to deny the parameterization on the operating panel in order to return to the regular operating state. Alternatively confirmation is possibly by means of the service code 6.1.05 = 33.
IGBT $\vartheta >$	38	IGBT overtemperature, determined by the thermal mathematical model.
Control requ. missing	46	Control bit (b10) of the bus control word is low.
I-limit active	51	The actual mains current is limited to the maximum operating current.
PTC/LI (SW2) wrong	58	Switch SW2 is not in position LI.
Sync-Alarm	59	If a fault is detected during the synchronisation of several Active Front End units connected in parallel, an alarm or a trip takes place depending on the setting of parameter 2.1.02.

04/2013

8 P02 517 EN.00/00

Trip messages

Detected fault	Short text	LED keypad	Description
Overvoltage DC	OBF	E02	The DC link voltage has exceeded the protection level of 825 V. As the evaluation only occurs with impulse inhibit, a line overvoltage situation takes place !
Line overvoltage	OSF	E03	The mains voltage set with parameter 2.1.01 does not correspond with the existing mains situation.
MC not ready	CRF	E04	The line control is not ready after the charging process.
Precharging fault	CRF2	E06	Blown fuse in the charging DC link of the LFM
Line fault 1p	PHF1	E08	Loss of one mains phase detected
Line fault 2-3p	PHF	E09	Loss of two or three mains phases detected
Overcurrent	SCF	E10	Overcurrent (mains current)
earth fault	GRF	E11	Ground (earth) fault at the output
Insulation fault	IGF	E12	The determined DC current is 25 % higher than the nominal current.
switching freq. >>	OCF	E13	Pulse frequency too high
AFE overload	TJF	E14	IGBT overtemperature caused by overload, determined by the thermal mathematical model
AFE overtemp.	OHF	E19	Overtemperature (insufficient cooling, check fans, ...)
Unknown MC	MC1	E20	Unknown power part
PTC short circuit	THSC	E21	Monitoring of the internal temperature sensor (short-circuit at a thermistor sensor)
PTC open circuit	THOC	E22	Monitoring of the internal temperature sensor (a thermistor sensor is open)
ASIC Init fault	CPR	E23	ASIC on the line control cannot be initialized.
IGBT fault	HwF	E25	The desaturation protection of an IGBT has triggered.
Differential current >>	DCF	E26	The current difference between the power parts connected in parallel is too high. The registration occurs only at devices with parallel IGBT power parts.
Current measure fault	CMF	E30	Signal interruption at the current transformer. Check voltage supply or evaluation electronics.
MC E ² zones invalid	MC2	E32	Values missing in the EEPROM of the line control
CPU fault	CPU	E33	Inadmissible state of the CPU
ISL fault	ISL	E34	Interruption of communication at the internal serial link
MTHA fault	MTHA	E35	Unauthorized state of time measurement (undervoltage time determination)
PWR fault	PRF	E37	No 24 V at the logic input PWR
Opt. comm. fault	ILF	E39	Interruption of communication at an option card
Wrong option card	INF6	E40	Damaged or unknown option card used
Bus error	BUSF	E41	A bus communication fault has been detected due to exceeded run time or interruption of control.
Param. config. fault	CFI	E42	Parameter settings invalid
Configuration fault	CFF	E57	EEPROM application software incompatible or changed power part
External fault	FLT1	E58	An external trip is signaled via a logic input (see 2.4.01...2.4.04).
Precharging fault	LCF	E60	Inadmissible state in the LFM, the control of the LFM or mains voltage missing
Internal SW error	SW	E64	Invalid state of the software
Power rating fault	PRT	E65	Unclear power part assignment

Detected fault	Short text	LED keypad	Description
Incompatible MC	INF2	E66	Line control is not compatible with the application software
Flash fault APP	ERR2	E67	Inadmissible state of the Flash Eprom of the applicative
Indus zone fault	ERR3	E68	Invalid values for calibration on the applicative
Eprom fault APP	EFF1	E69	Inadmissible state of the EEprom of the applicative
24V fault	STP	E73	Missing external 24 V buffer voltage
AFE overload	OHF2	E81	Protective shut-down due to exceeding the maximum current/time specification.
Sync-Error	SYNC	E86	An unauthorized state occurred in case of parallel connection of two or more Active Front End units. Check parameterization and wiring.

Schneider Electric Power Drives GmbH

Ruthnergasse 1
A-1210 Vienna
Phone: +43 (0) 1 29191 0
Fax: +43 (0) 1 29191 15

Due to evolution of standards and equipment, the characteristics indicated in texts and images of this document do not constitute a commitment on our part without confirmation.
Design: Schneider Electric Power Drives
Photos: Schneider Electric Power Drives