

OsiSense® XU

XUPH001 Communication Box for Picking Sensor User Guide

(Original Document)

06/2016



The information provided in this documentation contains general descriptions and/or technical characteristics of the performance of the products contained herein. This documentation is not intended as a substitute for and is not to be used for determining suitability or reliability of these products for specific user applications. It is the duty of any such user or integrator to perform the appropriate and complete risk analysis, evaluation and testing of the products with respect to the relevant specific application or use thereof. Neither Schneider Electric nor any of its affiliates or subsidiaries shall be responsible or liable for misuse of the information contained herein. If you have any suggestions for improvements or amendments or have found errors in this publication, please notify us.

No part of this document may be reproduced in any form or by any means, electronic or mechanical, including photocopying, without express written permission of Schneider Electric.

All pertinent state, regional, and local safety regulations must be observed when installing and using this product. For reasons of safety and to help ensure compliance with documented system data, only the manufacturer should perform repairs to components.

When devices are used for applications with technical safety requirements, the relevant instructions must be followed.

Failure to use Schneider Electric software or approved software with our hardware products may result in injury, harm, or improper operating results.

Failure to observe this information can result in injury or equipment damage.

© 2016 Schneider Electric. All rights reserved.

Schneider Electric Head Office
35 Rue Joseph Monier
CS 30323
92506 Rueil-Malmaison, France

Table of Contents



	Safety Information	5
	About the Book	7
Chapter 1	General Information	11
	System Presentation	12
	Topology	13
	System View	18
Chapter 2	Specifications	21
	XUPH Communication Box Characteristics	22
	Dimensions of the XUPH Communication Box	24
Chapter 3	Installing the System	25
	Description of the XUPH Communication Box	26
	Connecting the XUPH Communication Box	28
	Accessories	34
Chapter 4	Commissioning	37
	Commissioning	38
	IP Address Configuration	42
Chapter 5	Operating Principles	45
5.1	XUPH Communication Box System Memory Zone	46
	XUPH Communication Box System Memory Zone	46
5.2	Common Objects	48
	0000 h / %MW0: Operating Mode	49
	0001 h / %MW1: Picking Sensors Address/Group	50
	0016 h / %MW22: Detected Error Codes	53
	0017 h / %MW23: Diagnostic	54
5.3	Objects in Multi-sequences Mode (Mode 3)	55
	0003 h / %MW3: Sequence Step Number	56
	0004 h / %MW4: Sequence Number	57
	0005 h / %MW5: Sequence Management	58
	0018...0019h / %MW24...%MW25: Save / Restore	60
	0180...01FFh / %MW384...%MW511: Buffer to Save / Restore the Sequences	63
5.4	Objects in PLC Mode (Mode 4)	64
	0002 h / %MW2: Picking Sensors LEDs Configuration	65
	0003 h / %MW3: Quantity of Addressed Picking Sensors	67
	0004 h / %MW4: Outputs Control	68

	0005 h / %MW5: Set/Reset of LEDs and Sensors	69
	0006...0011h / %MW6...%MW17: Picking Sensors LEDs Control . . .	71
	0012...0015h / %MW18...%MW21: Sensors Status	73
	0189...0191h / %MW390...%MW401: Picking Sensors Status	74
	01C0...01FFh / %MW448...%MW511: XUPK Network Listing	75
Chapter 6	Modbus TCP/IP Communications Support	77
	Modbus Commands Supported by The XUPH Communication Box . . .	78
	Modbus Requests Description	80
	Modbus Application Example	84
Chapter 7	XUPH Standalone applets Launcher	87
7.1	XUPH Standalone applets Launcher Overview	88
	XUPH Standalone applets Launcher Overview	89
	Install XUPH Standalone applets Launcher	90
7.2	Ethernet Setup	92
	Ethernet Setup Panel	92
7.3	Internal Registers	99
	Control Register	99
7.4	Multi-sequences	103
	Multi-sequences	104
	Remote Controller	105
	Save/Restore	109
Glossary	115
Index	121

Safety Information



Important Information

NOTICE

Read these instructions carefully, and look at the equipment to become familiar with the device before trying to install, operate, or maintain it. The following special messages may appear throughout this documentation or on the equipment to warn of potential hazards or to call attention to information that clarifies or simplifies a procedure.



The addition of this symbol to a “Danger” or “Warning” safety label indicates that an electrical hazard exists which will result in personal injury if the instructions are not followed.



This is the safety alert symbol. It is used to alert you to potential personal injury hazards. Obey all safety messages that follow this symbol to avoid possible injury or death.

DANGER

DANGER indicates a hazardous situation which, if not avoided, **will result in** death or serious injury.

WARNING

WARNING indicates a hazardous situation which, if not avoided, **could result in** death or serious injury.

CAUTION

CAUTION indicates a hazardous situation which, if not avoided, **could result in** minor or moderate injury.

NOTICE

NOTICE is used to address practices not related to physical injury.

PLEASE NOTE

Electrical equipment should be installed, operated, serviced, and maintained only by qualified personnel. No responsibility is assumed by Schneider Electric for any consequences arising out of the use of this material.

A qualified person is one who has skills and knowledge related to the construction and operation of electrical equipment and its installation, and has received safety training to recognize and avoid the hazards involved.

About the Book



At a Glance

Document Scope

This manual describes how to use the XUPH Communication Box and associated accessories.

Validity Note

The technical characteristics of the devices described in this manual also appear online. To access this information online:

Step	Action
1	Go to the Telemecanique Sensors home page www.tesensors.com .
2	In the Search box, type the model number of a product or the name of a product range. <ul style="list-style-type: none">● Do not include blank spaces in the model number/product range.● To get information on a grouping similar modules, use asterisks (*).
3	If you entered a model number, go to the Product datasheets search results and click on the model number that interests you. If you entered the name of a product range, go to the Product Ranges search results and click on the product range that interests you
4	If more than one model number appears in the Products search results, click on the model number that interests you.
5	Depending on the size of your screen, you may need to scroll down to see the data sheet.
6	To save or print a data sheet as a .pdf file, click Download XXX product datasheet .

The characteristics that are presented in this manual should be the same as those characteristics that appear online. In line with our policy of constant improvement, we may revise content over time to improve clarity and accuracy. If you see a difference between the manual and online information, use the online information as your reference.

Product Related Information

CAUTION

UNINTENDED EQUIPMENT OPERATION

The application of this product requires expertise in the design and programming of control systems. Only persons with such expertise must be allowed to program, install, alter, and apply this product.

Follow all local and national safety codes and standards.

Failure to follow these instructions can result in injury or equipment damage.

DANGER

HAZARD OF ELECTRIC SHOCK, EXPLOSION OR ARC FLASH

- Disconnect all power from all equipment including connected devices prior to removing any covers or doors, or installing or removing any accessories, hardware, cables, connectors or wires except under the specific conditions specified in this user guide.
- Always use a properly rated voltage sensing device to confirm that the power is off.
- Unplug the power cable from both the equipment and the power supply.
- Replace and secure all covers, accessories, hardware, cables, and wires and confirm that a proper ground connection exists before applying power to the equipment.
- Use only the specified voltage when operating this equipment and any associated products.

Failure to follow these instructions will result in death or serious injury.

Related Documents

Title of documentation	Reference number
XUPK Picking Sensor - Instruction Sheet	EAV97775
XUPH XUPH Communication Box - Instruction Sheet	EAV97780

You can download these technical publications and other technical information from our website at www.tesensors.com.

QR Code

A QR code including the Telemecanique Sensors web address is present on the device. Technical files and documents are available in this website.



User Comments

We welcome your comments about this document. You can reach us by e-mail at customer-support@tesensors.com.

Chapter 1

General Information

What Is in This Chapter?

This chapter contains the following topics:

Topic	Page
System Presentation	12
Topology	13
System View	18

System Presentation

Picking

Installed on an assembly zone, the Picking Sensor system assists the operator by indicating the different parts “to be taken” in the right order. This is the **assembly sequence** to follow.

The Picking Sensors should be installed above containers of an assembly zone. A Picking Sensor is composed by:

- A visualization zone with green and red LEDs that indicates the part “to take”, “taken”, or “wrong take”.
- A sensor that can detect the hand of the operator.

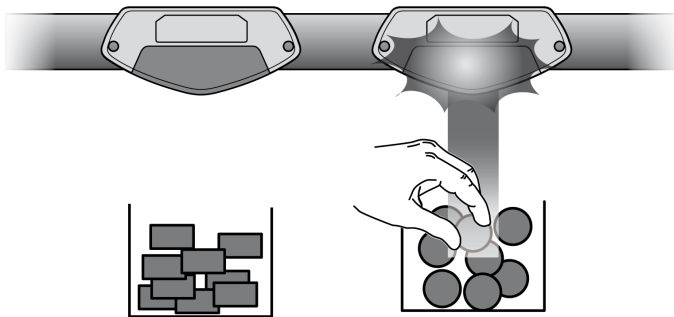

Depending of the user mode chosen, the system can manage the lightning of LEDs: right side or left side, continuous light or flashing, for a time period, with delays or not.

It is also possible to start a sequence or to take the full lead on the programming.

For wide container, the Picking Sensors can be set by pair or more to propose a wide range of hand detection.

The XUPH Communication Boxes ables to control one or several Picking Sensor systems by PC, PLC, HMI, or SCADA.

Topology

Description

Picking Sensors can be used in different modes:

Operating mode		Equipment needed	Picking Sensor		Automatic sequence number
Description	No.		Part number	Quantity	
Point-to-point mode Each Picking Sensor is connected directly to a PLC.	1	No PLC No XUPH	XUPK1	No limits Depends on the PLC I/O	No: PLC program
Single chained mode Several Picking Sensors can be connected together through a daisy chain. They are only connected to 1 power supply. The sequence runs automatically.	2			14 per daisy chain 64 maximum	1 per daisy chain Manual teaching
Multi-sequences mode Thanks to a XUPH Communication Box, a Modbus TCP master (PLC, HMI, or PC) manages different sequences stored in Picking Sensors. These sequences must previously be taught manually.	3	Up to 32 XUPH (if chained) Modbus TCP master (PLC, HMI, or PC).	XUPK2	64 per XUPH 14 per daisy chain	52 per XUPH Manual teaching
PLC mode Thanks to a XUPH Communication Box, a PLC program commands the different Picking Sensors.	4			64 per XUPH 14 per daisy chain	No: PLC program

NOTE: For more information see chapter commissioning ([see page 37](#)).

NOTE: The Point-to-point and the Single chained modes (Modes 1 and 2) are not using XUPH Communication Box. Their following description are for information only.

Point-to-point Mode (Mode 1)

Example of a Point-to-point mode (mode 1) wiring:

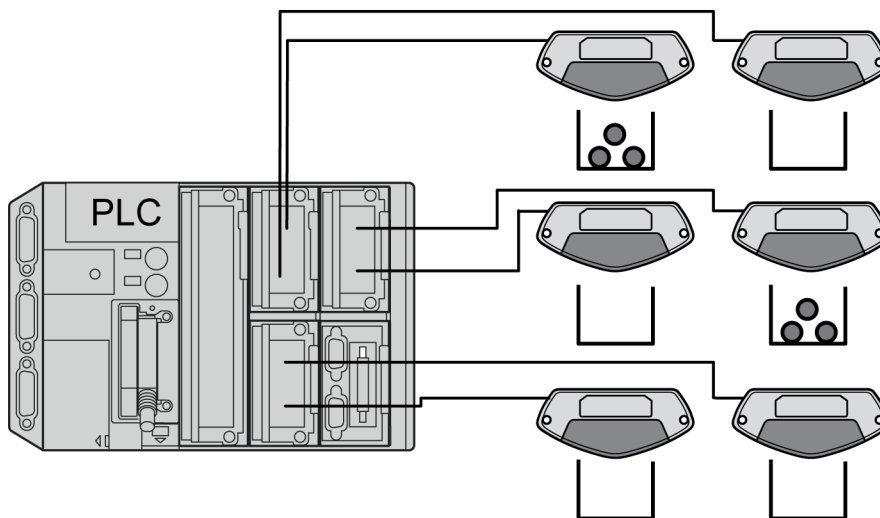

In this mode, each Picking Sensor XUPK1 is wired to the PLC by direct point-to-point connection.

The Picking Sensor works as a digital I/O device:

- The input commands the green light for signaling the zone “to be taken”.
- The output is the signal given by the photoelectric sensor that detects the hand of the operator.

When input is OFF and the photoelectric sensor detects a hand, output is ON and the light is flashing red to indicate “wrong take”.

The assembly sequences must be realized by the PLC program.

For more details, refer to Picking Sensors Instruction Sheet ([see page 8](#)).

Single chained Mode (Mode 2)

Example of a single chained mode wiring (with 3 daisy chains):

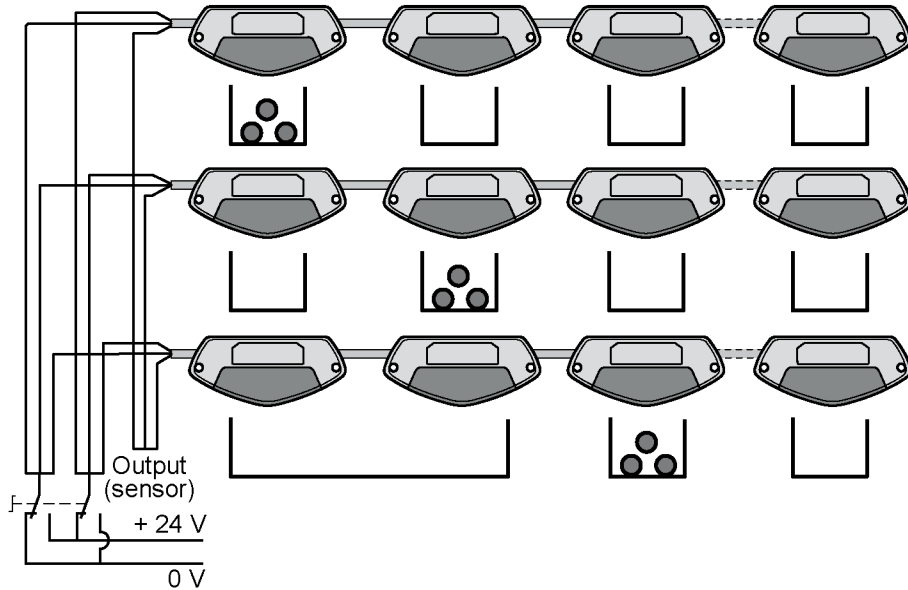

On the Picking Sensors network, you can connect up to 64 Picking Sensors XUPK1, maximum 14 per daisy-chain.

The Picking Sensors network maximum length is the shortest length between:

- 5 m + 1 m x quantity of XUPK1 (16.4 ft+ 3.28 ft x quantity of XUPK1).
- 40 m (131.2 ft) (2 XUPK1 minimum).

In this configuration, you can program only one automatic sequence for one assembly.

For more details, refer to Picking Sensors Instruction Sheet ([see page 8](#)).

Multi-sequences Mode (Mode 3) and PLC Mode (Mode 4)

Example of a Modbus TCP master (PLC, HMI, or PC) monitoring through the XUPH Communication Box mode wiring:

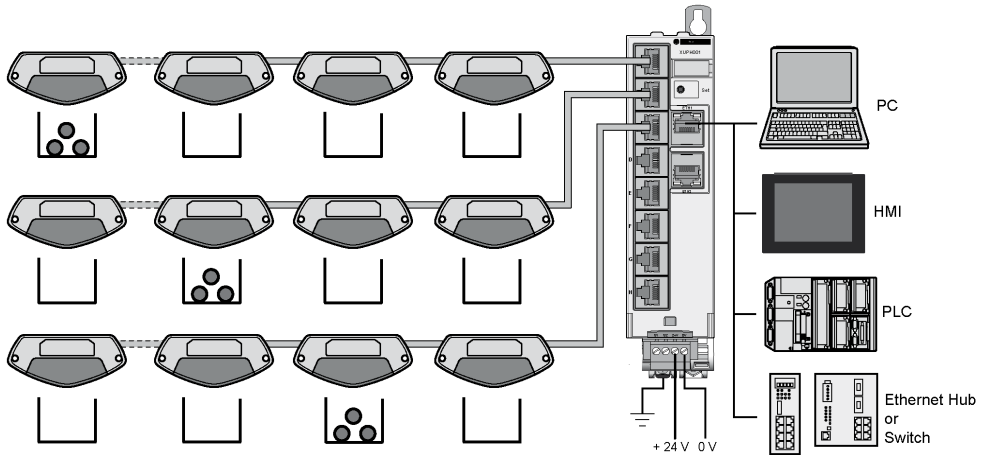

You can connect to a XUPH Communication Box up to 64 Picking Sensors XUPK2, maximum 14 per daisy-chain.

The Picking Sensors network is the total cabling between the Picking Sensors and the 8 RJ45 connectors on the XUPH Communication Box.

The Picking Sensors network maximum length is the shortest length between:

- 100 m + 1 m x quantity of Picking Sensors (328 ft + 3.28 ft x quantity of Picking Sensors).
- 164 m (538 ft) (2 XUPK2 minimum).

On a Modbus TCP/IP communication network:

- you can connect up to 32 XUPH Communication Boxes when chained.
- the maximum length between two nodes is 80 m (262.5 ft).

Multi-sequences mode (mode 3):

Thanks to one XUPH Communication Box, a Modbus TCP master (PLC, HMI, or PC) can manage up to 52 automatic sequences stored in the Picking Sensors. These sequences must previously be taught manually.

The Modbus TCP master (PLC, HMI, or PC) only has to manage the automatic sequences (start/stop sequence, change sequence number, start/stop manual sequence teaching) sending commands to the XUPH Communication Box.

PLC mode (mode 4):

The automatic sequences are not available in this mode.

The LEDs and the sensors must be managed by the PLC program (through exchanges with a table of words in the XUPH Communication Box).

The internal LEDs behavior and the sensors configuration can be modified.

System View

Description

XUPH Communication Box can be used with a protocol-compliant scanner as part of control system architecture. The embedded dual Ethernet port on the XUPH Communication Box allows you to use the network topology that meets your application needs. These topologies include the following:

- Star
- Daisy-chain
- Ring (daisy-chain with loopback)
- Combination of star and daisy-chain

Star

Star topology allows you to connect additional network equipment. Performing maintenance on one module (for example, by removing the network cable, or by cycling power to the module) does not affect other modules.

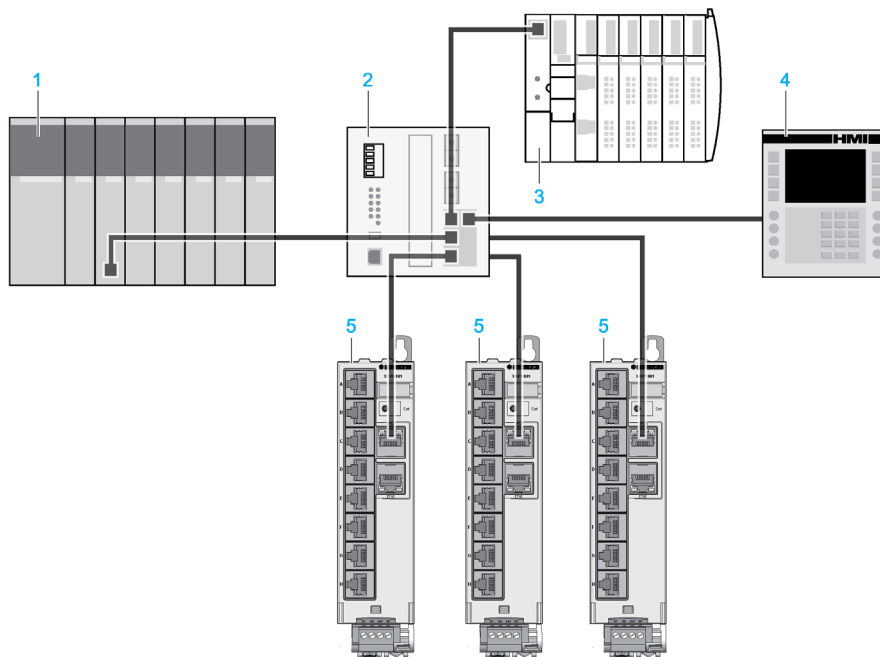

- 1 Quantum PLC
- 2 Ethernet switch
- 3 Advantys STB Island
- 4 Magelis HMI device
- 5 XUPH Communication Box

Daisy-Chain

You can create a daisy-chain topology by using the embedded switch ports to connect a series of up to 32 XUPH Communication Box.

NOTE:

When considering the daisy-chain topology, note that:

- Performing maintenance on any module not physically located at the end of the daisy-chain (for example, by removing the network cable, or by cycling power to the module) affects any modules located down the chain from the maintained module.
- You can connect at the end of this daisy-chain any type of Ethernet equipment.

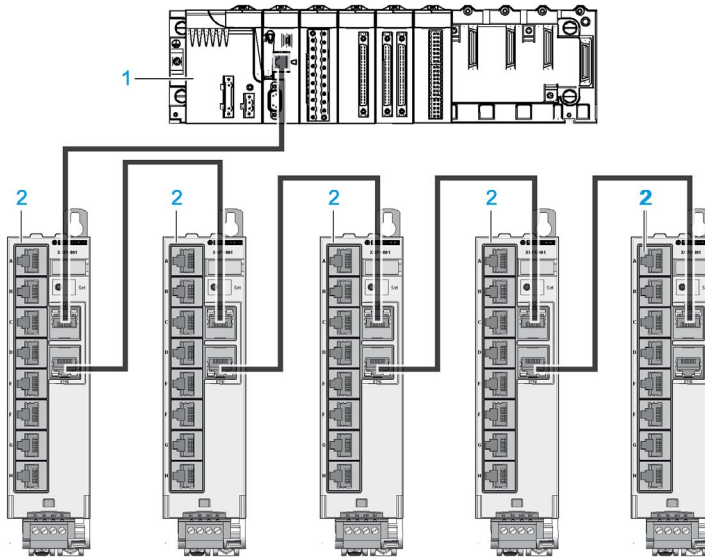

- 1 M340 PLC
- 2 XUPH Communication Box

Ring

You can create a ring topology by using a switch with redundancy management protocol (for example ConneXium TCSESM043F23F0).

You can connect a series of up to 32 XUPH Communication Box.

NOTE:

When considering the ring topology, note that:

- If a network segment becomes inoperable or is cut, all XUPH Communication Box remain operational.
- You can connect in this ring another equipment if it also has an embedded dual port Ethernet switch.

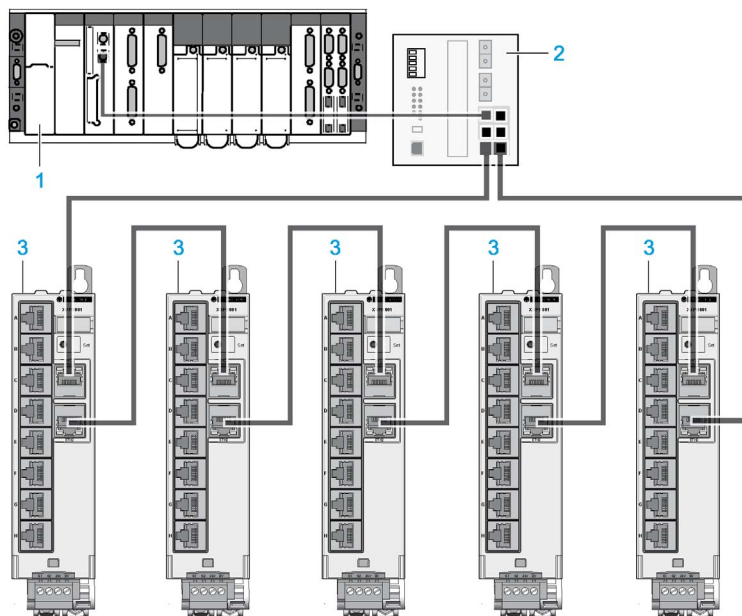

- 1 Premium PLC
- 2 Ethernet switch with loopback function
- 3 XUPH Communication Box

For more information, refer to the accessories range ([see page 34](#)).

Chapter 2

Specifications

What Is in This Chapter?

This chapter contains the following topics:

Topic	Page
XUPH Communication Box Characteristics	22
Dimensions of the XUPH Communication Box	24

XUPH Communication Box Characteristics

Environmental Characteristics

The table gives the technical characteristics of the XUPH Communication Box:

Characteristic		Designed to specification	Value
Temperature	Operation	-	-10...+55 °C (-14...+131 °F)
	Storage	-	-20...+80 °C (-4...+176 °F)
Degree of protection		IEC/EN 60529	IP20 RJ45 protective cover or cable must be installed in the RJ45 connectors
Vibration resistance		IEC/EN 60068-2-6	7 g _n ± 1.5 mm from 10 to 50 Hz
Shock resistance		IEC/EN 60068-2-27	30 g _n for a duration of 11 ms

Electromagnetic Susceptibility

The table gives the technical characteristics of the XUPH Communication Box:

Characteristic	Designed to specification	Value
Electrostatic discharge	IEC/EN 61000-4-2	8 kV (air discharge) 4 kV (contact discharge)
Radiated electromagnetic field	IEC/EN 61000-4-3	10 V/m (80...2700 MHz)
Fast transients burst	IEC/EN 61000-4-4	2 kV @ 5 kHz
Surge immunity	IEC/EN 61000-4-5 between the power supply wires (Differential mode)	0.5 kV 500 Ω
	IEC/EN 61000-4-5 between the ground and power supply wires (Common mode)	1 kV 500 Ω
Immunity to conducted magnetic fields	IEC/EN 61000-4-6	3 V (0.15...80 MHz)
Emission	EN 55011	Class A

Main Characteristics

The table gives the main characteristics of the XUPH Communication Box:

Characteristic	Details		Value
Power supply	-		10...30 Vdc
Current consumption	XUPH alone (with S1=S2=S3 = 0 A)	10 Vdc	150 mA
		30 Vdc	60 mA
	XUPK (with red and green LEDs ON)	10 Vdc	35 mA
		30 Vdc	35 mA
	XUPH + 64 XUPK (with S1+S2 = 200 mA)		≤ 2.7 A
S1, S2, S3 outputs	Logical type		PNP, Normally Open
	Maximum switching current		100 mA.
Picking Sensor limitations	-		Maximum 14 Picking Sensors in a daisy chain
			Maximum 64 Picking Sensors for the whole XUPH Communication Box

Dimensions of the XUPH Communication Box

Dimensions

The figure shows the dimensions of the XUPH Communication Box:

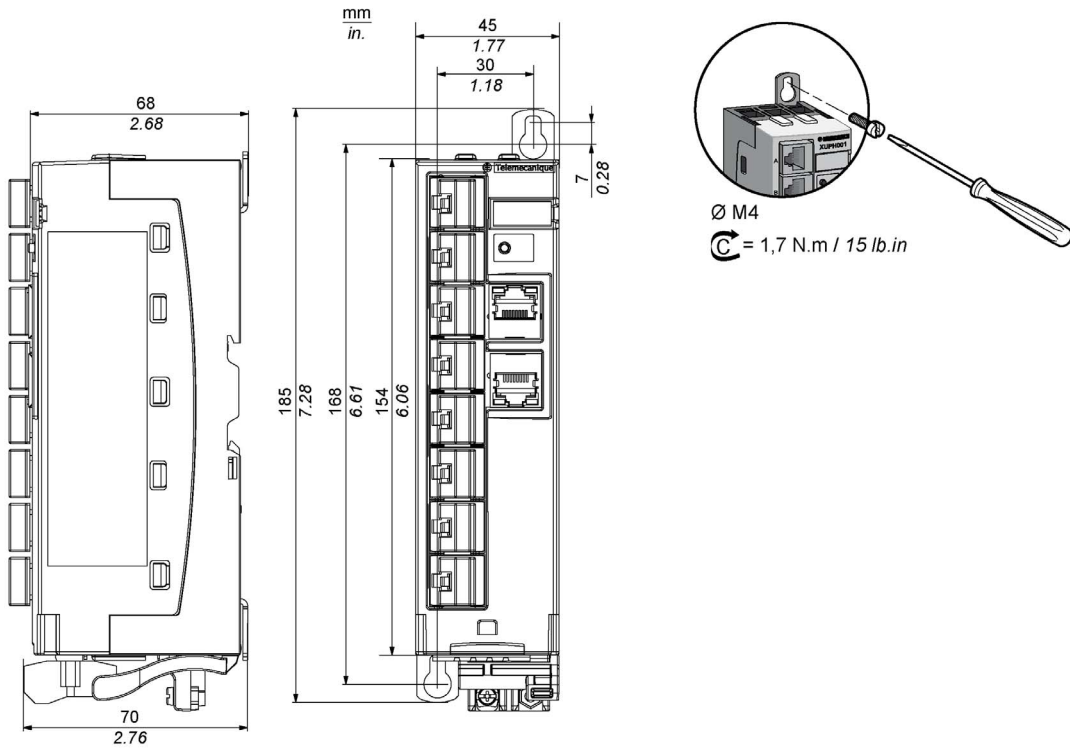

Chapter 3

Installing the System

What Is in This Chapter?

This chapter contains the following topics:

Topic	Page
Description of the XUPH Communication Box	26
Connecting the XUPH Communication Box	28
Accessories	34

Description of the XUPH Communication Box

Presentation of the XUPH Communication Box

The figure presents the XUPH Communication Box:

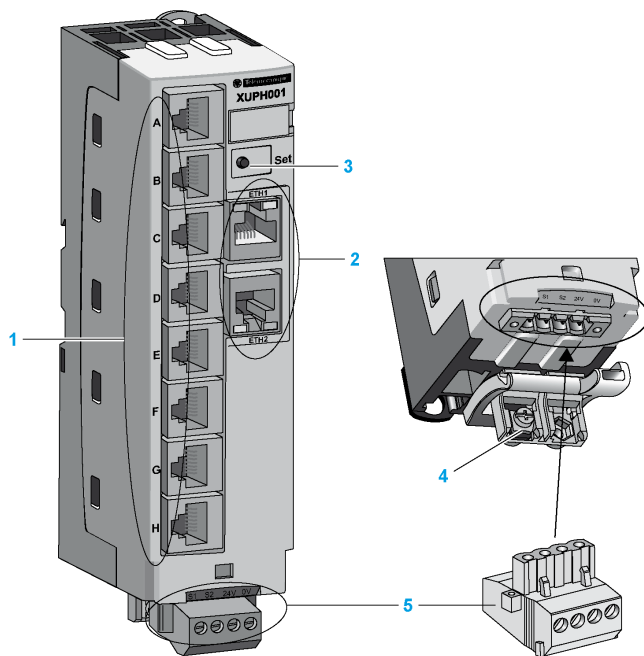

No.	Description
1	8 RJ45 connectors for the Picking Sensors only: maximum 14 in a daisy chain, maximum 64 for the whole XUPH Communication Box.
2	2 RJ45 connectors for Ethernet Modbus TCP/IP communication only.
3	1 set button to launch the diagnostic function (see page 41).
4	1 screw terminal for protective earth ground.
5	1 terminal block for 0, +24 Vdc, and 2 digital outputs.

Communication Status LED

The 2 RJ45 communication connectors have 2 status LEDs:

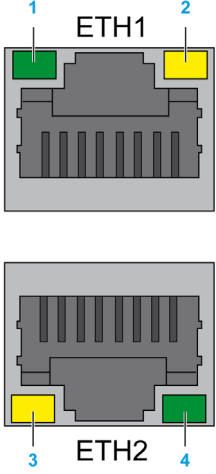
LED			Description	State
Illustration	No	State		
 <p>ETH1</p> <p>ETH2</p>	1	Steady off	Not powered or no IP address	Waiting for IP address setting (fixed or DHCP) address
		Flashing green	No connections	No connection established, and an exclusive owner connection with a client has not timed out.
		Solid green	Connected	At least one connection is established, and an exclusive owner connection with client has not timed out.
		Flashing red	Connection timeout	An exclusive owner connection with client has timed out.
		Solid red	Duplicate IP	The XUPH Communication Box has detected that its IP address is already in use.
		Flashing green/red	Self-test	The XUPH Communication Box is performing its power-on self test.
	2, 3	Solid green	Ethernet link present at 100 Mbit/s	Ok
		Flashing green	Traffic at 100 Mbit/s	Ok
		Solid yellow	Ethernet link present at 10 Mbit/s	Ok
		Flashing yellow	Traffic at 10 Mbit/s	Ok
4	Flashing green	The Ethernet module of the XUPH Communication Box is operational	Ok	
	Flashing red	Minor detected fault	The XUPH Communication Box has detected a recoverable minor fault. NOTE: An incorrect or inconsistent configuration is considered as a minor detected fault.	
	Solid red	Major detected fault	The XUPH Communication Box has detected a non-recoverable major fault on its Ethernet module.	
	Flashing green/red	Self-test	The XUPH Communication Box is performing its power-on self test.	

Connecting the XUPH Communication Box

Introduction

The XUPH Communication Box is equipped with:

- 8 RJ45 connectors for the Picking Sensors
- 2 RJ45 connectors for the Ethernet Modbus TCP/IP communication
- 1 screw terminal for protective earth ground
- A terminal block for 0 V, +24 Vdc, and 2 digital outputs

RJ45 Connectors for Communication (ETH1 and ETH2)

This table describes the RJ45 connectors for communication pinout:

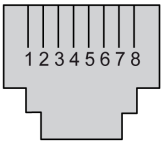
Signal	Description	RJ45 pin	RJ45 connector
TD+	Transmit Data +	1	
TD-	Transmit Data -	2	
RD+	Received Data +	3	
-	Not connected	4	
-	Not connected	5	
RD-	Received Data -	6	
-	Not connected	7	
-	Not connected	8	

NOTICE

INOPERABLE EQUIPMENT

Do not connect Picking Sensors to RJ45 connectors for communication (ETH1 and ETH2).

Failure to follow these instructions can result in equipment damage.

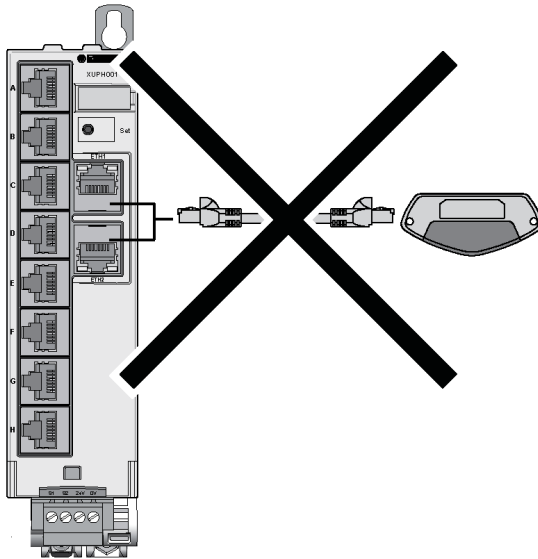

RJ45 Connectors for the Picking Sensors (A, B, C, D, E, F, G, H)

This table describes the RJ45 connectors for the Picking Sensors pinout:

Signal	RJ45 pin	RJ45 connector
Input (Green light)	1	
Output (sensor)	2	
0 Vdc	3	
24 Vdc	4	
24 Vdc	5	
0 Vdc	6	
Output (sensor)	7	
Input (Green light)	8	

NOTICE

INOPERABLE EQUIPMENT

Connect only Picking Sensors on the 8 RJ45 connectors for the Picking Sensors (A, B, C, D, E, F, G, H).

Failure to follow these instructions can result in equipment damage.

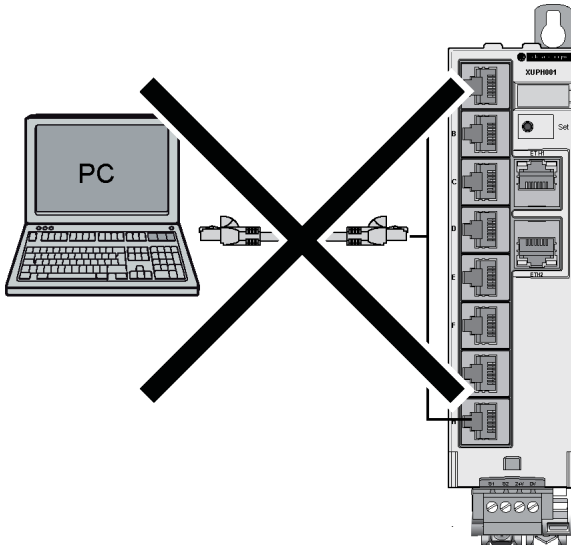

Terminal Block for Outputs



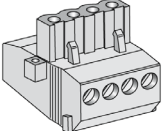







The table describes the terminal block pinout:

Terminal block	Label	Signal	Description in Multi-sequences mode (mode 3)
	1	S1 Detected error	Output is ON when a wrong taken is detected. Output keeps ON until the operator take the part indicated by the Picking Sensor lighted in Green
	2	S2 Sequence in progress	Output is ON during the sequence
	3	24 V	+24 Vdc
	4	0 V	0 Vdc

NOTE: In Multi-sequences mode (mode 3), the outputs are automatically controlled.

In PLC mode (Mode 4), the outputs are controlled by the PLC ([see page 68](#)).

The following table describes the cable types and wire sizes for the screw terminal block (I/Os):

						 mm/in.		 N.m lb.in	
mm ² 0,25...1,5	X	mm ² 0,2...1,5	mm ² 0,2...1	mm ² 0,2...1,5	mm ² 0,2...1	7	Ø 3,5 Ø 0.14	0,5 4.43	Ø 3 Ø 0.12
AWG 23...16	X	AWG 23...16	AWG 23...17	AWG 23...16	AWG 23...17	0.28			

For more information about outputs, refer to chapter Main Characteristics ([see page 23](#)).

WARNING

FIRE HAZARD

Use only the recommended wire sizes for the current capacity of the I/O channels and power supplies.

Failure to follow these instructions can result in death, serious injury, or equipment damage.

NOTICE



INOPERABLE EQUIPMENT

Do not tighten screw terminals beyond the specified maximum torque (Nm / lb-in.).





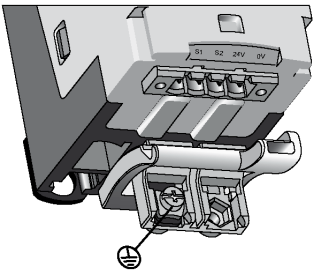





Failure to follow these instructions can result in equipment damage.

Protective Earth Ground Wiring

The table describes the screw:

Screws	Label	Signal
		Protective earth ground

The following table describes the cable types and wire sizes for the screw terminals (Power supply):

									
mm ² 1...1,5	mm ² 1...1,5	mm ² 1...2,5	mm ² 1...2,5	mm ² 1...2,5	mm ² 1...2,5	mm/in. 7	Ø 5	N.m lb.in	Ø 3
AWG 17...16	AWG 17...16	AWG 17...13	AWG 17...13	AWG 17...13	AWG 17...13	0.28	Phillips N°1	0,8...1,2 7.1...10.6	Ø 0.12

⚠ WARNING

POTENTIAL OF OVERHEATING AND FIRE

- Do not connect the equipment directly to line voltage.
- Use only isolating PELV power supply and fuse protection (1 A) (for example: Phaseo ABL 7/8 range of Schneider Electric).
- The 0 V must be connected to the ground to increase EMC strength.

Failure to follow these instructions can result in death, serious injury, or equipment damage.

⚠ WARNING**FIRE HAZARD**

Use only the recommended wire sizes for the current capacity of the I/O channels and power supplies.

Failure to follow these instructions can result in death, serious injury, or equipment damage.

NOTICE**INOPERABLE EQUIPMENT**

Do not tighten screw terminals beyond the specified maximum torque (Nm / lb-in.).

Failure to follow these instructions can result in equipment damage.

NOTE: If the polarity of the power supply is inverted, the XUPH Communication Box becomes inoperable (The %MW22 = 16d). In this case, follow the commissioning in Multi-sequences mode (mode 2) ([see page 38](#)).

Accessories

Introduction

The range of accessories is composed of cables, and Ethernet connection accessories.

Picking Sensors Cables and Connectors

The table shows the range of cables and connectors:

Description	Quantity	Length	Reference
Cable flat black straight AWG 26	1	20 m (65.6 ft)*	XUZPC001
RJ45 connectors	30	-	XUZPC002
Crimping tool RJ45 8P8C	1	-	XUZPC003
* The Picking Sensors network maximum length is the shortest length between: <ul style="list-style-type: none"> • 100 m + 1 m x quantity of Picking Sensors (328 ft + 3.28 ft x quantity of Picking Sensors). • 164 m (538 ft) (2 XUPK minimum). 			

Ethernet Cables and Connectors

The table shows the range of cables and connectors:

Description	Length	Reference
RJ45 / RJ45 cable, 4 pairs, cat 5E, grey colour	1 m (3.28 ft)	VDIP181546010
	2 m (6.56 ft)	VDIP181546020
	5 m (16.4 ft)	VDIP181546050
Ethernet copper cable (2 x 24 AWG shielded twisted pairs) Connectors to install	300 m (984.2 ft)*	TCSECN300R2
RJ45 connector Conforms to EIA/TIA-568-D	-	TCSEK3MDS
* To connect XUPH Communication Box to a Modbus TCP master network, the maximum length of Ethernet connecting cables made up in this way is 80 m (262.5 ft).		

Ethernet Connection Accessories

The table shows the range of Ethernet connection accessories:

Description	Reference
ConneXium Ethernet switch with loopback function	TCSESB..... TCSESM.....

Power Supply

The Schneider Electric part number ABL8RPS24... is recommended:

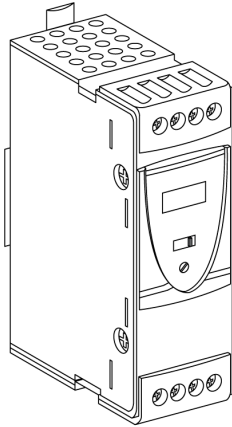

The following table presents some ABL8RPS24... power supply:

Input voltage	Secondary			Reset	Conforming to standard EN 61000-3-2	Reference	Weight
	Output voltage (V)	Nominal power (W)	Nominal current (A)				
<ul style="list-style-type: none"> ● Single to phase (N-L1) 100...120 Vac -15% +10% (50 Hz or 60 Hz) ● Phase to phase (L1-L2) 200...500 Vac -15% +10% (50 Hz or 60 Hz) 	24...28.8	72	3	Auto/ Manual	Yes	ABL8RPS24030	0.3 kg 0.66 lb
		120	5			ABL8RPS24050	0.7 kg 1.54 lb
		240	10			ABL8RPS24100	1.0 kg 2.2 lb

ABL8RPS24... Operating temperature range -25...60 °C (-13...140 °F) without derating.

Chapter 4

Commissioning

What Is in This Chapter?

This chapter contains the following topics:

Topic	Page
Commissioning	38
IP Address Configuration	42

Commissioning

Overview

Picking Sensors can be used in different operating modes:

No.	Description
1	Point-to-point mode Each Picking Sensor is connected directly to a PLC.
2	Single chained mode Several Picking Sensors can be connected together through a daisy chain. They are only connected to 1 power supply. The sequence runs automatically.
3	Multi-sequences mode Thanks to a XUPH Communication Box, a Modbus TCP client (PLC, HMI, or PC) manages different sequences stored in Picking Sensors. These sequences must previously be taught manually.
4	PLC mode Thanks to a XUPH Communication Box, a PLC program commands the different Picking Sensors.

For more explanation, refer to the chapter Topology ([see page 13](#)).

Commissioning in Point-to-point Mode (Mode 1)

For more details, refer to Picking Sensors Instruction Sheet ([see page 8](#)).

Commissioning in Single chained Mode (Mode 2)

For more details, refer to Picking Sensors Instruction Sheet ([see page 8](#)).

Commissioning in Multi-sequences Mode (Mode 3)

Picking Sensors XUPK2 are ready to be properly used in Multi-sequences mode (mode 3) when getting out the packaging box.

With the XUPH Standalone applets Launcher, proceed as follows:

Step	Action
1	If necessary, configure the XUPH Communication Box IP address (see page 42). NOTE: Each XUPH Communication Box must have a unique IP address.
2	Power on. Result: The Picking Sensors XUPK2 are green flashing.
3	Check your system in diagnostic mode (see page 41).
4	With the XUPH Standalone applets Launcher, follow the procedure record a sequence (see page 107).
5	With the XUPH Standalone applets Launcher, follow the procedure play a sequence (see page 107).

Step	Action
6	To make functional the save/restore process (see page 109), configure the unique address of the Picking Sensors (see page 50).

With a PLC, proceed as follows:

Step	Action	%MW5 value
1	If necessary, configure the XUPH Communication Box IP address (see page 42). NOTE: Each XUPH Communication Box must have a unique IP address.	255d
2	Power on. Result: The Picking Sensors XUPK2 are green flashing.	255d
3	Check your system in diagnostic mode (see page 41).	255d
4	Write %MW0 = 3 (To configure each Picking Sensor in Multi-sequences mode (mode 3)).	255d
5	Write %MW4 = new sequence number (see page 57).	255d
6	Write %MW5 = 1. Result: XUPH Communication Box automatically writes %MW5 = 255d when the command has been correctly executed.	1
7	Check the %MW5 value.	255d
8	Come through the beam of the first Picking Sensor of the sequence to define the first part to be taken. Result: Picking Sensor green LEDs light ON.	255d
9	Wait until Picking Sensor green LEDs light OFF (2 seconds). NOTE: For wide container zone, you can associate 2 or more Picking Sensors. Come through the beam of the others Picking Sensors of the zone during this 2 seconds period to associate them to the first one activated in the zone.	255d
10	Repeat steps 8 and 9 for the needed Picking Sensors until the end of the sequence.	255d
11	Write %MW5 = 0 to stop teaching. Result: XUPH Communication Box automatically writes %MW5 = 255d when the command has been correctly executed.	0
12	Check the %MW5 value.	255d
13	Write %MW5 = 2 to play the sequence once. Write %MW5 = 3 to play the sequence in loop.	255d
14	To make functional the save/restore process (see page 60), configure the unique address of the Picking Sensors (see page 50).	255d

Possible actions and corresponding words in the XUPH Communication Box memory:

Possible use	Corresponding words
Change the Picking Sensor operating mode	%MW0 (see page 49)
Change the Picking Sensor address	%MW1 (see page 50)
Read the step of the running sequence	%MW3 (see page 56)
Change a sequence number	%MW4 (see page 57)
Play/Stop a sequence	%MW5 (see page 58)
Start/Stop a sequence teaching	%MW5 (see page 58)
Read the detected error codes	%MW22 (see page 53)
Realize a hardware diagnostic	%MW23 (see page 54)
Save / restore the sequences	%MW24...%MW25 (see page 60)
Buffer to save / restore the sequences	%MW384...%MW511 (see page 63)

Commissioning in PLC Mode (Mode 4)

Proceed as follows:

Step	Action
1	If necessary, configure the XUPH Communication Box IP address (see page 42). NOTE: Each XUPH Communication Box must have a unique IP address.
2	Check your system in diagnostic mode (see page 41).
3	Write %MW0 = 4 (To configure the Picking Sensors in PLC Mode (Mode 4)).
4	Configure the Picking Sensors unique address (see page 50).

Possible actions and corresponding words in the XUPH Communication Box memory:

Possible use	Corresponding words
Change the Picking Sensor operating mode	%MW0 (see page 49)
Change the Picking Sensor address	%MW1 (see page 50)
Modify the Picking Sensor LEDs and sensors operating configuration	%MW2 (see page 65)
Check the quantity of addressed Picking Sensors	%MW3 (see page 67)
Control the outputs	%MW4 (see page 68)
Reset the LEDs and sensors of the addressed Picking Sensors in 1 command	%MW5 (see page 69)
Control the LEDs of the addressed Picking Sensors	%MW6...%MW17 (see page 71)
Read the sensor status of the addressed Picking Sensors	%MW18...%MW21 (see page 73)
Read the detected error codes	%MW22 (see page 53)
Realize a hardware diagnostic	%MW23 (see page 54)

Diagnostic Function

To launch manually the diagnostic function, proceed as follows:

Step	Action
1	<p>Press and maintain the set button (see page 26) 3...10 seconds.</p> <p>Result: All the Picking Sensors are flashing red.</p> <p>If a Picking Sensor is not flashing red:</p> <ul style="list-style-type: none"> ● Check that it is a XUPK2. ● Check the Picking Sensors network (cables). ● Check the polarity of the power supply. If it is inverted, correct it and configure the Picking Sensor XUPK2 in Single chained Mode (Mode 2) (see page 38). <p>After these tests, if the Picking Sensor XUPK2 still not flashing red, replace it.</p>
2	<p>Come through the beam of a Picking Sensor.</p> <p>Result: Picking Sensor green LEDs light ON.</p> <p>If not, replace it.</p>
3	<p>Repeat step 2 for all the Picking Sensors.</p>
4	<p>Press and maintain the set button more than 3 seconds to stop the diagnostic function.</p>

IP Address Configuration

Overview

IP address: Every item of equipment connected to an Ethernet network must have a unique IP address. This address makes it possible to refer to a specific unit.

Subnet mask: The subnet mask defines a range of IP addresses that can be accessed from an item of equipment.

The table describes the standard IP subnet masks:

Network class	Host bits	Subnet mask
A	24	255.0.0.0
B	16	255.255.0.0
C	8	255.255.255.0

The table gives an example of accessible address ranges depending on the network class:

Network class	Addresses	Accessible addresses ranges
B	IP: 192.168.0.1 Mask: 255.255.0.0	IP: 192.168.xxx.xxx
C	IP: 192.168.0.1 Mask: 255.255.255.0	IP: 192.168.0.xxx

NOTE: xxx represents a possible value from 0 to 255.

Do not use xxx.xxx.xxx.255 IP address that is reserved for broadcasting.

Address Configuration

The XUPH Communication Box factory default IP address is 192.168.0.10.

The Picking Sensors do not use IP addresses.

The configuration of the IP address is made by setting parameters with the XUPH Standalone applets Launcher to:

- Manually set the IP address,
- Automatically get an IP address from the DHCP server.

Carefully manage the IP addresses because each device on the network requires a unique address. Having multiple devices with the same IP address can cause unpredictable operation of your network and associated equipment.

⚠ WARNING

UNINTENDED EQUIPMENT OPERATION

- Verify that there is only one logic controller configured on the network.
- Verify that all devices have unique addresses.
- Obtain your IP address from your system administrator.
- Confirm that the IP address of the device is unique before placing the system into service.
- Do not assign the same IP address to any other equipment on the network.
- Update the IP address after cloning any application that includes Ethernet communications to a unique address.

Failure to follow these instructions can result in death, serious injury, or equipment damage.

NOTE: This device comes pre configured with an IP address of 192.168.0.10. Change this default address before using the device on the network. Remember to validate this change after resetting the device to factory defaults.

It is good practice to ensure that your system administrator maintains a record of all assigned IP addresses on the network and subnetwork, and to inform the system administrator of all configuration changes performed.

NOTE: You can use **IP recovery tool** if the IP address of the XUPH Communication Box is unknown.

This tool is available at www.tesensors.com.

Configuring IP Address

Follow the procedure to configure the IP address of a XUPH Communication Box:

Step	Action
1	Install and launch the XUPH Standalone applets Launcher (see page 90).
2	Follow the XUPH Communication Box IP address configuration procedure (see page 93).

NOTE: The network configuration of the PC must be compatible with the IP address range of the XUPH Communication Box.

Chapter 5

Operating Principles

What Is in This Chapter?

This chapter contains the following sections:

Section	Topic	Page
5.1	XUPH Communication Box System Memory Zone	46
5.2	Common Objects	48
5.3	Objects in Multi-sequences Mode (Mode 3)	55
5.4	Objects in PLC Mode (Mode 4)	64

Section 5.1

XUPH Communication Box System Memory Zone

XUPH Communication Box System Memory Zone

Description of the System Memory Zone

Composition of the system memory zone:

Objects			Description	Usable in mode (2)		Access ⁽¹⁾
				3	4	
0000 h	%MW0	<i>(see page 49)</i>	Operating modes	X	X	R/W
0001 h	%MW1	<i>(see page 50)</i>	Picking Sensors addressing	X	X	R/W
0002 h	%MW2	<i>(see page 65)</i>	Picking Sensors LEDs configuration	-	X	R/W
0003 h	%MW3	<i>(see page 56)</i>	Sequence step number	X	-	R
		<i>(see page 67)</i>	Quantity of addressed Picking Sensors	-	X	R
0004 h	%MW4	<i>(see page 57)</i>	Sequence number	X	-	R/W
		<i>(see page 68)</i>	Outputs control	-	X	R/W
0005 h	%MW5	<i>(see page 58)</i>	Sequence management	X	-	R/W
		<i>(see page 69)</i>	Reset of LEDs and sensors	-	X	R/W
0006...0011h	%MW6...%MW17	<i>(see page 71)</i>	Picking Sensors LEDs control	-	X	R/W
0012...0015h	%MW18...%MW21	<i>(see page 73)</i>	Sensors status	-	X	R/W
0016 h	%MW22	<i>(see page 53)</i>	Detected error codes	X	X	R
0017 h	%MW23	<i>(see page 54)</i>	Diagnostic	X	X	R/W
0018...0019h	%MW24...%MW25	<i>(see page 60)</i>	Save/Restore	X	-	R/W
0180...01FFh	%MW384...%MW511	<i>(see page 63)</i>	Buffer to Save/Restore	X	-	R/W
0189...0191h	%MW390...%MW401	<i>(see page 74)</i>	Picking Sensors LEDs status	-	X	R/W
01C0...01FFh	%MW448...%MW511	<i>(see page 75)</i>	Picking Sensor Network Listing	-	X	R/W

(1) R = Read, W = Write

(2) Operating modes 3 and 4 defined in %MW0

NOTE: Record/play and play/stop the sequences can also be done with the XUPH Standalone applets Launcher (*see page 87*).

To facilitate maintenance in Multi-sequences mode (mode 3), it is recommended to configure the unique address of each Picking Sensor as soon as their installation. For this, use the object 0001 h / %MW1: Picking Sensor Address ([see page 50](#)).

Section 5.2

Common Objects

What Is in This Section?

This section contains the following topics:

Topic	Page
0000 h / %MW0: Operating Mode	49
0001 h / %MW1: Picking Sensors Address/Group	50
0016 h / %MW22: Detected Error Codes	53
0017 h / %MW23: Diagnostic	54

0000 h / %MW0: Operating Mode

Description

This object controls the Picking Sensors operating mode:

Value	Description	Picking Sensors
3d	Multi-sequences mode (default value)	XUPK2
4d	PLC mode	

For more details, refer to the chapter General information ([see page 11](#)).

0001 h / %MW1: Picking Sensors Address/Group

Description

This object controls the Picking Sensors addressing.

By default, each Picking Sensor have the address 0.

In Multi-sequences mode (mode 3), the Picking Sensors address is not mandatory. Nevertheless, the addresses are mandatory for the save/restore process.

In PLC mode (mode 4), each Picking Sensor must have a unique address.

In addition, this object controls groups of Picking Sensors.

By default, each Picking Sensor is assigned to the group 0.

You can assign Picking Sensors to 4 groups.

This table describes the Picking Sensors addressing:

Value	Description
0d	End of addressing.
1...64d	Launch the function to configure the address of a specific Picking Sensor with the corresponding value (see page 51).
65...99d	Reserved.
100...104d	Launch the function to assign Picking Sensors in group 0...4. The Picking Sensors are in group 0 (default group)
105...253d	Reserved.
254d	Launch a step-by-step function to configure the address of all the connected Picking Sensors (see page 51).
255d	Reserved.

NOTE: Acknowledgement: XUPH Communication Box automatically writes %MW1 = 255d when the command has been correctly executed.

Configure the Address of a Specific Picking Sensor

Proceed as follow to configure the address of a specific Picking Sensor:

Step	Action	%MW1 value
1	Write %MW1 = xx (decimal) (xx is the address to be attributed to the Picking Sensor). Result: The Picking Sensors are flashing green. If the address is already used, the corresponding Picking Sensor is flashing red. Result: XUPH Communication Box automatically writes %MW1 = 255d when the command has been correctly executed.	1...64d
2	Check the %MW1 value.	255d
3	Come through the beam of the Picking Sensor to be addressed. Result: The Picking Sensor lights green for 1 second. Result: If the address was already used, the old corresponding Picking Sensor has now its address = 0.	255d
4	The Picking Sensors blink green 4 times and becomes OFF.	255d

Configure the Address of All the Connected Picking Sensor

Proceed as follow to configure the address of all the connected Picking Sensors:

Step	Action	%MW1 value
1	Write %MW1 = 254 (decimal). Result: The Picking Sensors are flashing green. Result: XUPH Communication Box automatically writes %MW1 = 255d when the command has been correctly executed.	254d
2	Check the %MW1 value.	255d
3	Come through the beam of the first Picking Sensor to be addressed. Result: This Picking Sensor lights OFF. Its address is 1.	
4	Repeat the step 3 with each Picking Sensor. The address is automatically incremented.	
5	Write %MW1 = 0 to stop the addressing function. Result: The Picking Sensors light OFF. Result: XUPH Communication Box automatically writes %MW1 = 255d when the command has been correctly executed.	0
6	Check the %MW1 value.	255d

If the address of a Picking Sensor is equal to 0 (default value), the Picking Sensor cannot be managed in PLC mode (Mode 4).

NOTICE

INOPERABLE EQUIPMENT

You must consider that writing %MW1=254d reset the address of all the connected Picking Sensors.

Failure to follow these instructions can result in equipment damage.

Configure the Group of Picking Sensors

Proceed as follow to configure the group of Picking Sensors:

Step	Action	%MW1 value
1	Write %MW1 = 100...104 (decimal). 100 = group 0...104 = group 4 Result: The Picking Sensors are flashing green 4 times, then the Picking Sensors of the corresponding group light green. Result: XUPH Communication Box automatically writes %MW1 = 255d when the command has been correctly executed.	254d
2	Check the %MW1 value.	255d
3	Come through the beam of a Picking Sensor that lights OFF. Result: This Picking Sensor lights green. NOTE: If you come through the beam of a Picking Sensor that lights green, the Picking Sensor lights OFF and is assigned to group 0.	
4	Repeat the step 3 with each Picking Sensor.	
5	Write %MW1 = 0 to stop the function. Result: The Picking Sensors light OFF. Result: XUPH Communication Box automatically writes %MW1 = 255d when the command has been correctly executed.	0
6	Check the %MW1 value.	255d

0016 h / %MW22: Detected Error Codes

Description

This object contains the detected error codes:

Value	Description	Solution
0d	No error detected.	-
1d	Wrong take: A Picking Sensor with green LEDs OFF has detected something coming through its beam.	-
2d	Sequence with more than 64 steps.	Make a sequence with 1...64 steps.
3d	Sending command error detected.	<ul style="list-style-type: none"> ● Relaunch the previous command. ● Check the installation (launch a diagnostic with %MW23).
4d	Invalid sequence number in %MW4	Write a correct sequence number (0...51d) in %MW4.
5d	Unknown command	Correct your previous command.
6d	Receiving command error detected	<ul style="list-style-type: none"> ● Relaunch the previous command. ● Check the installation (launch a diagnostic with %MW23).
7d	Non-operating mode	Write a correct operating mode (2...4d) in %MW0.
8d	Picking Sensor already addressed	Correct the value in %MW1.
9d	Not used	-
10d	Buffer usable	The buffer (%MW384...%MW511) is ready to be read for a save operation.
11d	Checksum detected error	Redo the save or restore operation.
12d	Buffer loaded	The restore operation is done correctly.
13d 20...23d	Buffer timeout	<ul style="list-style-type: none"> ● Correct the value of %MW25. ● Check the installation (launch a diagnostic with %MW23). ● Check if Picking Sensor correctly addressed (%MW1).
14d	Initialization on going	Wait the end of the initialization.
15d	Not used	-
16d	XUPH Communication Box power supply inverted.	Invert the power supply of the XUPH Communication Box.

0017 h / %MW23: Diagnostic

Description

This object commands the diagnostic function. This function checks that all Picking Sensors are powered (red flashing) and checks that all Picking Sensors can change the output stage (green light):

Value	Description
0d	Stops the diagnostic function
1d	Run the diagnostic function
...	Reserved

NOTE: Acknowledgement: XUPH Communication Box automatically writes %MW23 = 255d when the command has been correctly executed.

Procedure to Launch the Diagnostic Function

To launch the diagnostic function:

Step	Action	%MW23 value
1	Write %MW23 = 1 Result: <ul style="list-style-type: none"> ● XUPH Communication Box automatically writes %MW23 = 255d when the command has been correctly executed. ● In Multi-sequences mode (mode 3), the running sequence is automatically stopped. ● In PLC mode (mode 4), the objects 0006...0015h / %MW6...%MW21 goes to 0. 	1
2	Check the %MW23 value.	255d
3	Check that all the Picking Sensors flash red.	255d
4	Come through the beam of a Picking Sensor. Result: If it works correctly, the green LEDs lights ON.	255d
5	Repeat the step 4 on each Picking Sensor.	255d
6	Write %MW23 = 0. Result: XUPH Communication Box automatically writes %MW23 = 255d when the command has been correctly executed.	0
7	Check the %MW23 value.	255d

When the diagnostic function is running, the %MW3 object contains the quantity of addressed Picking Sensors. For more information, refer to %MW3 ([see page 67](#)).

NOTE: The diagnostic function can also be launched with the set button ([see page 41](#)).

Section 5.3

Objects in Multi-sequences Mode (Mode 3)

What Is in This Section?

This section contains the following topics:

Topic	Page
0003 h / %MW3: Sequence Step Number	56
0004 h / %MW4: Sequence Number	57
0005 h / %MW5: Sequence Management	58
0018...0019h / %MW24...%MW25: Save / Restore	60
0180...01FFh / %MW384...%MW511: Buffer to Save / Restore the Sequences	63

0003 h / %MW3: Sequence Step Number

Description

This object is used differently in mode 3 and mode 4:

0003 h / %MW3	
Multi-sequences mode (mode 3)	PLC mode (mode 4)
Sequence step number	Quantity of Addressed Picking Sensors

This object contains the step of the running sequence:

Value	Description
1d	Step number of the running sequence.
...	...
64d	Step number of the running sequence.
65d...255d	Reserved.

0004 h / %MW4: Sequence Number

Description

This object is used differently in mode 3 and mode 4:

0004 h / %MW4	
Multi-sequences mode (mode 3)	PLC mode (mode 4)
Sequence number	XUPH Communication Box outputs

This object contains the current sequence number:

Value	Description
0 (default value)	Step by step operating: Picking Sensor are green lighting one by one. At each time you come through the beam, the Picking Sensor lights OFF and the next Picking Sensor lights ON. This sequence number is also used in Single chained mode (mode 2).
1...24d	Step by step operating: Picking Sensor are green lighting one by one. At each time you come through the beam, the Picking Sensor lights OFF and the next Picking Sensor lights ON.
25...51d	Random take: At the beginning of the sequence, all the concerned Picking Sensors green LEDs are ON. At each time you come through the beam, the Picking Sensor lights OFF.
...	Reserved.

0005 h / %MW5: Sequence Management

Description

This object is used differently in mode 3 and mode 4:

0005 h / %MW5	
Multi-sequences mode (mode 3)	PLC mode (mode 4)
Sequence management	Reset of LEDs and sensors

This object controls the sequence management:

Value	Description
0d	Stops the running sequence or stops the manual teaching.
1d	Starts the manual teaching of a sequence.
2d	Plays the sequence once.
3d	Plays the sequence in loop.
...	Reserved.
12d	Enable the flash at end of sequence functionality: at the end of a sequence, all the Picking Sensors flash green. This functionality is enable by default.
13d	Disable the flash at end of sequence functionality. NOTE: The status of this functionality is not stored in the Picking Sensors. You should integrate this modification in your application.
...	Reserved.

NOTE: Acknowledgement: XUPH Communication Box automatically writes %MW5 = 255d when the command has been correctly executed.

Record a Sequence

Proceed as follows to record a sequence:

Step	Action	%MW5 value
1	Write %MW4 = new sequence number (<i>see page 57</i>).	255d
2	Write %MW5 = 1. Result: XUPH Communication Box automatically writes %MW5 = 255d when the command has been correctly executed.	1
3	Check the %MW5 value.	255d
4	Come through the beam of the first Picking Sensor of the sequence to define the first part to be taken. Result: Picking Sensor green LEDs light ON.	255d

Step	Action	%MW5 value
5	Wait until Picking Sensor green LEDs light OFF (2 seconds). NOTE: For wide container zone, you can associate 2 or more Picking Sensors. Come through the beam of the others Picking Sensors of the zone during this 2 seconds period to associate them to the first one activated in the zone.	255d
6	Repeat steps 4 and 5 for the needed Picking Sensors until the end of the sequence.	255d
7	Write %MW5 = 0 to stop teaching. Result: XUPH Communication Box automatically writes %MW5 = 255d when the command has been correctly executed.	0
8	Check the %MW5 value.	255d

0018...0019h / %MW24...%MW25: Save / Restore

Description

These objects are used to save/restore the sequences taught in Multi-sequences Mode (Mode 3). These sequences are stored in each Picking Sensor memory.

The main use is to replace one or several out-of-order Picking Sensor quickly.

NOTE: To be saved/restored, the Picking Sensor must have a unique address (*see page 51*).

NOTE: With a PC, you can also use the XUPH Standalone applets Launcher (*see page 103*) to save/restore (*see page 109*).

0018 h / %MW24

This object controls the save/restore function:

Value	Description
0d	Stops writing: Exits save & restore mode.
1d	Save: writes the Picking Sensor memory content in the Modbus buffer (%MW384...%MW511). The address of the Picking Sensor is specified in %MW25.
2d	Restore: writes the Modbus buffer content in the Picking Sensor memory. The address of the Picking Sensor is specified in %MW25.
3d...255d	Reserved.

NOTE: Acknowledgement: XUPH Communication Box automatically writes %MW24 = 255d when the command has been correctly executed.

0019 h / %MW25

This object contains the address of the Picking Sensor to be saved or restored:

Value	Description
1d	Picking Sensor No 1
...	...
64d	Picking Sensor No 64
65d...255d	Reserved

Save the Picking Sensors Memory

Proceed as follow to save the Picking Sensors memory:

Step	Action	%MW24 value
1	Write %MW25 = xx (decimal) (xx is the address of the Picking Sensor to be saved).	255d
2	Write %MW24 = 1. Result: <ul style="list-style-type: none"> ● XUPH Communication Box automatically writes %MW24 = 255d when the command has been correctly executed. ● In Multi-sequences mode (mode 3), the running sequence is automatically stopped. ● In PLC mode (mode 4), the objects 0006...0015h / %MW6...%MW21 goes to 0. 	1
3	Wait 1 s.	255d
4	Check the %MW24 value.	255d
5	Check that %MW22 = 10d (there is an error detected if the value is different of 0 or 10d).	255d
6	Save the %MW384...%MW511 content (Picking Sensor memory).	255d
7	Repeat the steps 1...6 to save others Picking Sensors.	255d
8	Write %MW24 = 0. Result: XUPH Communication Box automatically writes %MW24 = 255d when the command has been correctly executed.	0
9	Wait 1.5 s	255d
10	Check the %MW24 value.	255d

Restore the Picking Sensors Memory

Proceed as follow to restore the Picking Sensors memory:

Step	Action	%MW24 value
1	Write in %MW384...%MW511 the data to be restored in the Picking Sensor.	0 or 255d
2	Write %MW25 = xx (decimal) (xx is the address of the Picking Sensor to be restored).	0 or 255d
3	Write %MW24 = 2d. Result: <ul style="list-style-type: none"> ● XUPH Communication Box automatically writes %MW24 = 255d when the command has been correctly executed. ● In Multi-sequences mode (mode 3), the running sequence is automatically stopped. ● In PLC mode (mode 4), the objects 0006...0015h / %MW6...%MW21 goes to 0. 	2
4	Wait 1.5 s	255d

Step	Action	%MW24 value
5	Check the %MW24 value.	255d
6	Check that %MW22 = 12d (there is an error detected if the value is different than 0 or 12d).	255d
7	Repeat the steps 1...6 to restore others Picking Sensors.	255d
8	Write %MW24 = 0. Result: XUPH Communication Box automatically writes %MW24 = 255d when the command has been correctly executed.	0
9	Wait 1.5 s	255d
10	Check the %MW24 value.	255d

0180...01FFh / %MW384...%MW511: Buffer to Save / Restore the Sequences

0180...01FFh / %MW384...%MW511

These objects are buffer to the save/restore processes (*see page 60*).

They contain the Picking Sensor memory after a save process.

They must contain a Picking Sensor memory before a restore process.

Section 5.4

Objects in PLC Mode (Mode 4)

What Is in This Section?

This section contains the following topics:

Topic	Page
0002 h / %MW2: Picking Sensors LEDs Configuration	65
0003 h / %MW3: Quantity of Addressed Picking Sensors	67
0004 h / %MW4: Outputs Control	68
0005 h / %MW5: Set/Reset of LEDs and Sensors	69
0006...0011h / %MW6...%MW17: Picking Sensors LEDs Control	71
0012...0015h / %MW18...%MW21: Sensors Status	73
0189...0191h / %MW390...%MW401: Picking Sensors Status	74
01C0...01FFh / %MW448...%MW511: XUPK Network Listing	75

0002 h / %MW2: Picking Sensors LEDs Configuration

Description

This object contains the LEDs operating configuration.

In Multi-sequences mode (mode 3), the LEDs operating configuration is not modifiable.

In PLC mode (mode 4), the Picking Sensors LEDs are controlled by the objects 0006...0011h / %MW6...%MW17, following the LEDs operating configuration in the object %MW2.

This table describes the Picking Sensors LEDs configuration:

Bit	Description	Value	Description
Bit 1, Bit 0	Green LEDs	00	Steady
		01	Slowly alternately
		10	Slow blinking (default value)
		11	Fast blinking
Bit 3, Bit 2	Red LED	00	Steady
		01	Steady
		10	Slow blinking
		11	Fast blinking (default value)
Bit 5, Bit 4	Fast blinking	00	10 Hz (flash per second)
		01	5 Hz (default value)
		10	2.5 Hz
		11	1.25 Hz
Bit 7, Bit 6	Slow blinking	00	Fast blinking/2
		01	Fast blinking/4 (default value)
		10	Fast blinking/8
		11	Fast blinking/16
Bit 8	Green LEDs/sensor interaction	0	No relation (default value)
		1	Green LEDs switched ON/OFF by the sensor
Bit 9	Red LED/sensor interaction	0	No relation (default value)
		1	Red LEDs switched ON/OFF by the sensor
Bit B, Bit A	Sensor temporization	00	0.25 s
		01	0.5 s
		10	1 s
		11	2 s (default value)

Bit	Description	Value	Description
Bit C	Green LEDs group	0	Right and left green LEDs dissociated (default value)
		1	Right and left green LEDs grouped
Bit D...Bit F	Reserved	0	Reserved

The %MW2 default value is 0C50h.

NOTE: A personalized value of %MW2 is not stored in the Picking Sensor. You should integrate this modification in your application and write your personalized %MW2 value after each XUPH Communication Box reset, power-on, operating mode modification (mode 3 / mode 4), or after a diagnostic.

NOTE: When the Green LEDs are grouped (Bit C of %MW2 = 1d), the objects %MW6...%MW9 are not updated. You must use the objects %MW10...%MW13 to control the green LEDs.

0003 h / %MW3: Quantity of Addressed Picking Sensors

Description

This object is used differently in mode 3 and mode 4:

0003 h / %MW3	
Multi-sequences mode (mode 3)	PLC mode (mode 4)
Sequence step number	Quantity of addressed Picking Sensors

Commands:

Value	Description
1...64d	<p>During operation, the object %MW3 indicates the last solicited Picking Sensor (the Picking Sensor detects an element coming through its beam).</p> <p>In addition, the object %MW3 indicates the quantity of addressed Picking Sensors:</p> <ul style="list-style-type: none"> • During the diagnostic %MW23 (see page 54) • After each Picking Sensor network listing function %MW448...%MW511 (see page 75), .

0004 h / %MW4: Outputs Control

Description

This object is used differently in mode 3 and mode 4:

0004 h / %MW4	
Multi-sequences mode (mode 3)	PLC mode (mode 4)
Sequence number	XUPH Communication Box outputs

This object commands the 2 outputs:

Bit	Value	Description
Bit 0	0/1	S1 (Output 1) status
Bit 1	0/1	S2 (Output 2) status
Bit 2...Bit F	0	Reserved

NOTE: In Multi-sequences mode (mode 3), the outputs are automatically controlled ([see page 31](#)). In PLC mode (Mode 4), the outputs are controlled by the PLC.

0005 h / %MW5: Set/Reset of LEDs and Sensors

Description

This object is used differently in mode 3 and mode 4:

0005 h / %MW5	
Multi-sequences mode (mode 3)	PLC mode (mode 4)
Sequence management	Set/Reset of LEDs and sensors

Commands:

Value	Description
0...3d	Reserved
4...10d	Set/Reset LEDs and sensor of all the Picking Sensors (See below).
11d	Send to all Picking Sensors %MW2 (see page 65).
12...13d	Reserved
14...50d	Set/Reset LEDs and sensor of the groups 1...4 of Picking Sensors (See below).
51d	Launch the Picking Sensor network listing function %MW448...%MW511 (see page 75).
...	Reserved

Set/Reset LEDs/sensor of all of the groups 1...4 of Picking Sensors:

Description	Value (decimal)				
	All	Group			
		1	2	3	4
Lights OFF green right LEDs. %MW10...%MW13 and %MW394...%MW397 goes to 0	4	14	24	34	44
Lights OFF green left LEDs. %MW6...%MW9 and %MW390...%MW393 goes to 0	5	15	25	35	45
Lights OFF red LEDs. %MW14...%MW17 and %MW398...%MW401 goes to 0	6	16	26	36	46
Reset sensors status to 0. %MW18...%MW21 goes to 0	7	17	27	37	47
Lights ON green right LEDs. %MW10...%MW13 and %MW394...%MW397 goes to 1	8	18	28	38	48
Lights ON green left LEDs. %MW6...%MW9 and %MW390...%MW393 goes to 1	9	19	29	39	49

Description	Value (decimal)				
	All	Group			
		1	2	3	4
Lights ON red LEDs. %MW14...%MW17 and %MW398...%MW401 goes to 1	10	20	30	40	50

NOTE: Acknowledgment: XUPH Communication Box automatically writes %MW5 = 255d when the command has been correctly executed.

0006...0011h / %MW6...%MW17: Picking Sensors LEDs Control

Description

These objects command the Picking Sensors LEDs.

Green left LEDs command:

%MW	Bit 15	...	Bit 0
%MW6	Picking Sensor No 16	...	Picking Sensor No 1
%MW7	Picking Sensor No 32	...	Picking Sensor No 17
%MW8	Picking Sensor No 48	...	Picking Sensor No 33
%MW9	Picking Sensor No 64	...	Picking Sensor No 49

Green right LEDs command:

%MW	Bit 15	...	Bit 0
%MW10	Picking Sensor No 16	...	Picking Sensor No 1
%MW11	Picking Sensor No 32	...	Picking Sensor No 17
%MW12	Picking Sensor No 48	...	Picking Sensor No 33
%MW13	Picking Sensor No 64	...	Picking Sensor No 49

Red LEDs command:

%MW	Bit 15	...	Bit 0
%MW14	Picking Sensor No 16	...	Picking Sensor No 1
%MW15	Picking Sensor No 32	...	Picking Sensor No 17
%MW16	Picking Sensor No 48	...	Picking Sensor No 33
%MW17	Picking Sensor No 64	...	Picking Sensor No 49

Set a bit=1 to command to the corresponding LED to light ON.

After each modification in the LED command tables (%MW6...%MW17), a command is sent to the Picking Sensors.

When the command is executed correctly, the corresponding bit is updated in the status LED tables %MW390...%MW401 (*see page 74*).

If an error is detected, the status LED tables %MW390...%MW401 are not updated and the detected error is indicated in object %MW22 (*see page 53*).

NOTE: When you modify several bit at the same time, the LED status commands are sent one by one. In this case, you must consider that the time delay for each command is 20 ms. To command all the LED (or the groups 1...4), it is recommended to use %MW5 (*see page 69*).

NOTE: When the right and left Green LEDs are grouped (Bit C of %MW2 =1d), the objects %MW6...%MW9 are not updated. You must use the objects %MW10...%MW13 to control the green LEDs.

NOTE: To command a LED flashing, it is recommended to use the LEDs configuration (%MW2) instead of continuously changing the value of the corresponding bit. This avoids a sending/receiving command error.

0012...0015h / %MW18...%MW21: Sensors Status

Description

These objects contain the sensors status of the Picking Sensors:

%MW	Bit 15	...	Bit 0
%MW18	Picking Sensor No 16	...	Picking Sensor No 1
%MW19	Picking Sensor No 32	...	Picking Sensor No 17
%MW20	Picking Sensor No 48	...	Picking Sensor No 33
%MW21	Picking Sensor No 64	...	Picking Sensor No 49

As long as the Picking Sensor detects an element coming through its beam, the corresponding bit = 1. After that, the bit stays at 1 during a time defined in %MW2 and finally comes back to 0.

NOTICE

INOPERABLE EQUIPMENT

Do not send too much request between XUPH Communication Box and Picking Sensors. In that case, a detection request send by a Picking Sensor could be not received by the XUPH Communication Box.

Failure to follow these instructions can result in equipment damage.

0189...0191h / %MW390...%MW401: Picking Sensors Status

Description

These objects contain the exact status of the Picking Sensors.

These objects can be used to check that all requests are completed.

Green left LEDs status:

%MW	Bit 15	...	Bit 0
%MW390	Picking Sensor No 16	...	Picking Sensor No 1
%MW391	Picking Sensor No 32	...	Picking Sensor No 17
%MW392	Picking Sensor No 48	...	Picking Sensor No 33
%MW393	Picking Sensor No 64	...	Picking Sensor No 49

Green right LEDs status:

%MW	Bit 15	...	Bit 0
%MW394	Picking Sensor No 16	...	Picking Sensor No 1
%MW395	Picking Sensor No 32	...	Picking Sensor No 17
%MW396	Picking Sensor No 48	...	Picking Sensor No 33
%MW397	Picking Sensor No 64	...	Picking Sensor No 49

Red LEDs status:

%MW	Bit 15	...	Bit 0
%MW398	Picking Sensor No 16	...	Picking Sensor No 1
%MW399	Picking Sensor No 32	...	Picking Sensor No 17
%MW400	Picking Sensor No 48	...	Picking Sensor No 33
%MW401	Picking Sensor No 64	...	Picking Sensor No 49

When the bit=1, the corresponding LED lights ON.

NOTE: When the Green LEDs are grouped (Bit C of %MW2 =1d), the objects %MW390...%MW393 are not updated. You must use the objects %MW394...%MW397 to control the green LEDs or to read their status.

01C0...01FFh / %MW448...%MW511: XUPK Network Listing

Description

This table contains the addressed Picking Sensors and the group of each one.

This table is updated:

- At each XUPH Communication Box power-on
- At each entering in PLC mode; %MW0 = 4 ([see page 49](#))
- At each modification of the Picking Sensors addresses/groups; %MW1 ([see page 50](#))
- At each time %MW5 = 51d ([see page 69](#))

The update takes several seconds(2...4 s). During the table update, %MW22=14.

These objects contain information for the 64 Picking Sensors:

%MW	Description
%MW448	Picking Sensor with the address 1
...	...
%MW511	Picking Sensor with the address 64

Each object contains 2 information of the corresponding Picking Sensor:

MSB		LSB	
Value	Description	Value	Description
0	<ul style="list-style-type: none"> • None Picking Sensor has the corresponding address • Picking Sensor incompatible 	0	The corresponding Picking Sensor is not in a group (default value).
...	Version number of the corresponding Picking Sensor	1	The corresponding Picking Sensor is in group 1.
		2	The corresponding Picking Sensor is in group 2.
		3	The corresponding Picking Sensor is in group 3.
		4	The corresponding Picking Sensor is in group 4.

Chapter 6

Modbus TCP/IP Communications Support

Introduction

This chapter describes how a XUPH Communication Box can be accessed from other devices on a Modbus TCP/IP fieldbus network.

What Is in This Chapter?

This chapter contains the following topics:

Topic	Page
Modbus Commands Supported by The XUPH Communication Box	78
Modbus Requests Description	80
Modbus Application Example	84

Modbus Commands Supported by The XUPH Communication Box

Introduction

Modbus is the protocol used by Modicon PLCs. Modbus defines the message structure that the PLCs understand and use, regardless of network type. The Modbus protocol describes the process that a controller uses to access another device, how that device responds, and how detected errors are reported.

The XUPH Communication Box is a client on a Modbus TCP system.

It can be connected to any system with Modbus TCP master, including these:

- PLC (function blocks or I/O scanner)
- HMI
- SCADA
- Computer

NOTICE

INOPERABLE EQUIPMENT

The Unit ID of the XUPH Communication Box on Modbus TCP is fixed to 1, the XUPH Communication Box is addressed by its IP address.

Failure to follow these instructions can result in equipment damage.

Modbus Message Data Frame

Modbus messages are embedded within the frame or packet structure of the network in use. A Modbus over TCP/IP network uses both the Ethernet II and IEEE 802.3 data formats. For communications with the XUPH Communication Box, Modbus messages can be embedded in either frame type. Ethernet II is the default data format.

Modbus Message Structure

The Modbus protocol uses a 16-bit word. A Modbus message begins with a header. A Modbus message uses a Modbus function code ([see page 79](#)) as the first byte.

Following is a description of the structure of a Modbus message header:

Invoke identifier	Protocol type	Command length	Destination ID	Modbus message
Two-byte field that associates a request with a response	Two-byte field Value for Modbus is always 0	Two-byte field Value is the size of the rest of the message	One-byte	N-byte field First byte is the Modbus function code

List of Supported Commands

The table lists the Modbus commands that the XUPH Communication Box supports:

Modbus function code	Subfunction or subindex	Command
03 h (<i>see page 80</i>)	-	Read n words ($1 \leq n \leq 125$)
06 h (<i>see page 81</i>)	-	Write one word
10 h (<i>see page 81</i>)	-	Write n words ($1 \leq n \leq 123$)
2Bh (<i>see page 82</i>)	0Eh	ID

Modbus Requests Description

Read N Registers

This function is used to read tables of registers.

Read request:

Slave no.	Function code	Address of 1st register	Number of registers	Check
01 h	3 h	Hi Lo	Hi Lo	
1 byte	1 byte	2 bytes	2 bytes	2 bytes (RTU mode)

- Slave no.: 01 h
- Function code: 3 h
- Address of first register: Corresponds to the address of the first register to be read in the XUPH Communication Box (depending on the address)
- Number of registers: $1 \leq N \leq 125$

Response:

Slave no.	Function code	Number of bytes read	Value of 1st register		Value of last register	Check
01 h	3 h		Hi Lo		Hi Lo	
1 byte	1 byte	1 byte	2 bytes		2 bytes	2 bytes (RTU mode)

- Slave no.: 01 h
- Function code: Same as read request
- Number of bytes read: 2 to 250
- Value of the registers read: 0000 h to FFFFh

The response is an echo of the request, indicating that the value contained in the request has been taken into account by the XUPH Communication Box.

Write One Register

Write request:

Slave no.	Function code	Address of register	Register value	Check
01 h	6 h	Hi Lo	Hi Lo	
1 byte	1 byte	2 bytes	2 bytes	2 bytes (RTU mode)

- Slave no.: 01 h
- Function code: 6 h
- Address of register: Same addressing field as for the read request
- register values: 0000 h to FFFFh

Response:

Slave no.	Function code	Address of register	Register value	Check
01 h	6 h	Hi Lo	Hi Lo	
1 byte	1 byte	2 bytes	2 bytes	2 bytes (RTU mode)

The response is an echo of the request, indicating that the value contained in the request has been taken into account by the XUPH Communication Box

Write N Registers

Write request:

Slave no.	Function code	Address of 1st register	Number of registers	Number of bytes	Value of 1st register		Value of last register	Check
01 h	10 h	Hi Lo	Hi Lo		Hi Lo		Hi Lo	
1 byte	1 byte	2 bytes	2 bytes	1 byte	2 bytes		2 bytes	2 bytes (RTU mode)

- Slave no.: 01 h
- Function code: 10 h
- Number of registers: $1 \leq N \leq 123$
- Number of bytes: Twice the number of registers
- Register values: 0000 h to FFFFh

Response:

Slave no.	Function code	Address of 1st register written		Number of registers written		Check
01 h	10 h	Hi	Lo	Hi	Lo	
1 byte	1 byte	2 bytes		2 bytes		2 bytes (RTU mode)

- Slave no.: 01 h
- Function code: Same as request
- Address of first register written: Same as request
- Number of registers written: Same as request

Identification Request

Function 2Bh: This function is used to identify the device.

Read request:

Slave no.	Function code	MEI *	Read Device IDcode	Object ID
01 h	2Bh	0Eh	01 h, 02 h, 03 h	00 h

*: MEI = Modbus Encapsulated Interface

Response:

Index	Object name & description	Description	Data type
0 (0000h)	Manufacturer name	TELEMECANIQUE	ASCII string
1 (0001h)	Product code	-	
2 (0002h)	Version number	Vx.y (for example: V3.6)	

Detected Error Messages

When an anomaly in the message (or during its execution) is detected by the XUPH Communication Box to which it is addressed, the XUPH Communication Box sends back a detected error message to the master system.

Syntax:

Slave no.	Function code	Detected error code	Check
1 byte	1 byte	1 byte	2 bytes (RTU mode)

- Slave no.: 01 h
- Function code: Same as the function code and most significant bit of the byte set at 1

Examples:

- Function code of the detected error message after a read request:
83 h = (80 + 03)
- Function code of the detected error message after a write request:
90 h = (80 + 10)

Detected error code:

- 1 h: Unknown function code or incorrect request format
- 2 h: Incorrect address or prohibited zone

Modbus Application Example

Application Example

A XUPH Communication Box and a Premium PLC are connected to a Modbus TCP/IP network.

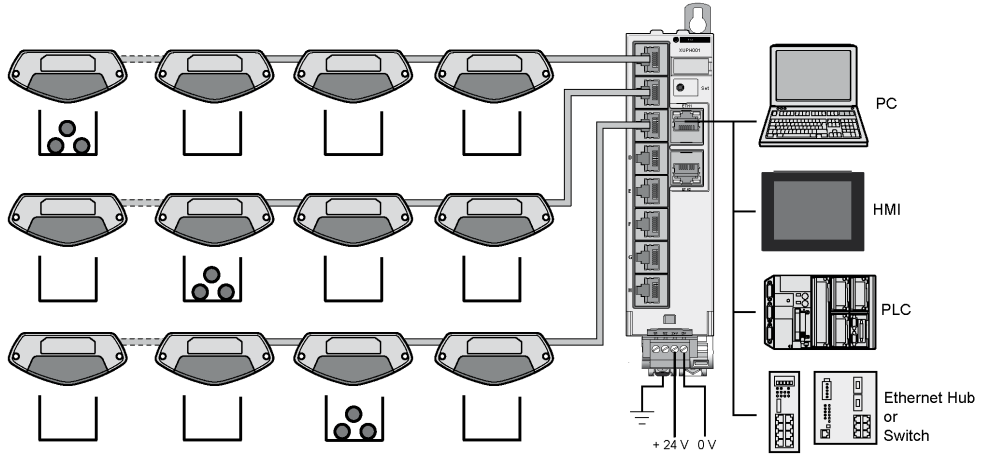

139.160.0.243: IP address of the PLC.

139.160.0.10: IP address of the XUPH Communication Box.

Example of Program in Unity Pro

Program example: Read the sensors status (objects %MW18...%MW21).

NOTE: The Modbus address of the XUPH Communication Box is always 1 (fixed address).

LADDER programming

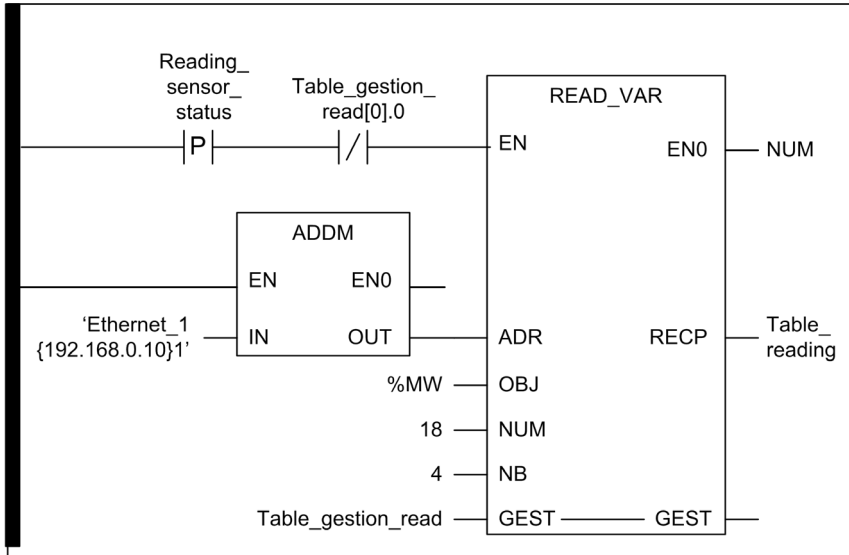

Structured Text programming

```

If RE (Reading_sensor_status) and not Table_gestion_read[0].0 then
  Table_gestion_read[2] := 20; (* Timeout COMM *)
  READ_VAR (
    ADR := ADDM('Ethernet_1{192.168.0.10}1'),
    OBJ := '%MW',
    NUM := 18,
    NB := 4,
    GEST := Table_gestion_read,
    RECP => Table_reading);
  RESET (Reading_sensor_status);
End_if;
  
```

Table_reading		ARRAY[0...3] OF INT
●	Table_reading[0]	INT
●	Table_reading[1]	INT
●	Table_reading[2]	INT
●	Table_reading[3]	INT

Table_gestion_read		ARRAY[0...3] OF INT
●	Table_gestion_read[0]	INT
●	Table_gestion_read[1]	INT
●	Table_gestion_read[2]	INT
●	Table_gestion_read[3]	INT

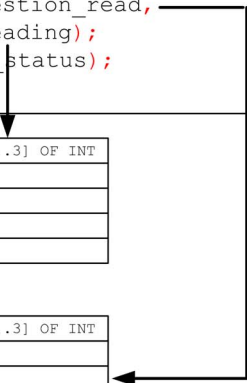

Chapter 7

XUPH Standalone applets Launcher

What Is in This Chapter?

This chapter contains the following sections:

Section	Topic	Page
7.1	XUPH Standalone applets Launcher Overview	88
7.2	Ethernet Setup	92
7.3	Internal Registers	99
7.4	Multi-sequences	103

Section 7.1

XUPH Standalone applets Launcher Overview

What Is in This Section?

This section contains the following topics:

Topic	Page
XUPH Standalone applets Launcher Overview	89
Install XUPH Standalone applets Launcher	90

XUPH Standalone applets Launcher Overview

XUPH Standalone applets Launcher Description

The XUPH Communication Box is used for the following modes:

- Multi-sequences mode (mode 3)
- PLC mode (mode 4)

The XUPH Communication Box has an embedded Web server. From this Web server, you can download the XUPH Standalone applets Launcher.

With the XUPH Standalone applets Launcher, you can:

- Configure the XUPH Communication Box (change IP, manage user login, view MAC address, ...),
- Multi-sequences Mode (Mode 3):
 - Manage the automatic sequences (start/stop sequence, select sequence number, start/stop manual sequence teaching)
 - Save/restore the memory of the Picking Sensors.
- Control registers of a XUPH Communication Box.

Install XUPH Standalone applets Launcher

Introduction

To access the XUPH Communication Box Web server, you need:

- Microsoft Windows 7 or 10,
- Microsoft Internet Explorer version ≥ 8 , Mozilla Firefox version ≥ 19 , or Microsoft Edge,
- Java runtime environment version ≥ 7 .

Before you begin, be sure that both your PC and the XUPH Communication Box have IP addresses that are located in the same subnet (or, alternatively, are connected via a routing mechanism).

Accessing the XUPH Communication Box Embedded Web Server

The procedure describes how to access the embedded Web server:

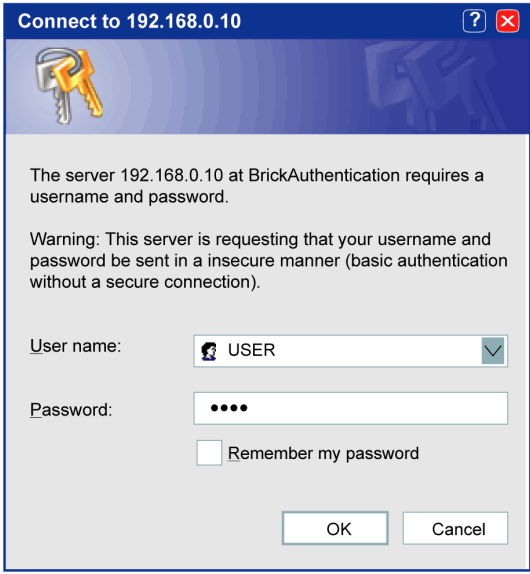
Step	Action
1	Connect the PC to the XUPH Communication Box on ETH1 or ETH2 connector (<i>see page 26</i>).
2	Power-on and wait at least 30 s (booting time). Verify ETH1 or ETH2 LED status (<i>see page 27</i>).
3	Open a web browser.
4	Enter the XUPH Communication Box factory setting IP address: <code>http://192.168.0.10</code> in the address line of the browser and hit Enter on your keyboard. NOTE: If you previously changed the IP address, you must instead enter the new one.
5	A dialog box opens and prompts you for a user name and password. 

Step	Action
6	Fill the fields User name and HTTP Password . The factory settings are: <ul style="list-style-type: none"> ● User name = USER ● Password = USER
7	Click OK . Your web browser displays the Web server home page.

Install the XUPH Standalone applets Launcher

For **Windows** users, this procedure describes how to download and install the XUPH Standalone applets Launcher:

Step	Action
1	Access to the XUPH Communication Box Embedded Web server.
2	Click Download for Windows to download the setup file.
3	Execute the setup file.
4	Launch the XUPH Standalone applets Launcher.

For **MAC/LINUX** users, this procedure describes how to download the XUPH Standalone applets Launcher:

Step	Action
1	Access to the XUPH Communication Box Embedded Web server.
2	Click Download the .JAR alone to download the JAVA executable file alone (cross platform).

NOTE: These files are contained in the XUPH Communication Box. To download latest versions, refer to www.tesensors.com.

Section 7.2

Ethernet Setup

Ethernet Setup Panel

Ethernet Setup Panel

The graphic shows the **Ethernet Setup** panel:

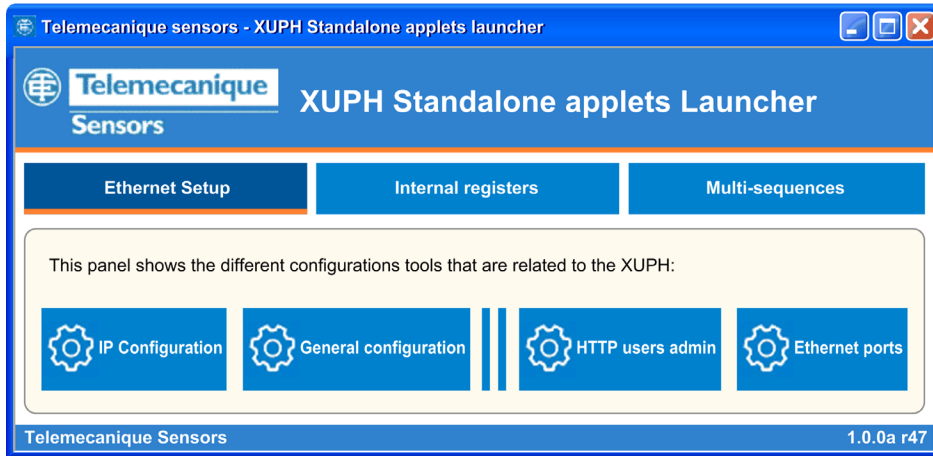

From the **Ethernet Setup** panel, you can access to:

- **IP Configuration** ([see page 93](#)) to configure the IP address of a XUPH Communication Box,
- **General Configuration** ([see page 95](#)) to configure:
 - The IP address of the XUPH Communication Box to communicate with
 - The language of the XUPH Standalone applets Launcher
- **HTTP Users Admin** ([see page 96](#)) to configure user accounts and passwords,
- **Ethernet Ports** ([see page 98](#)) to configure the 2 ports of the XUPH Communication Box,

IP Configuration

Follow the procedure to configure the IP address of a XUPH Communication Box:

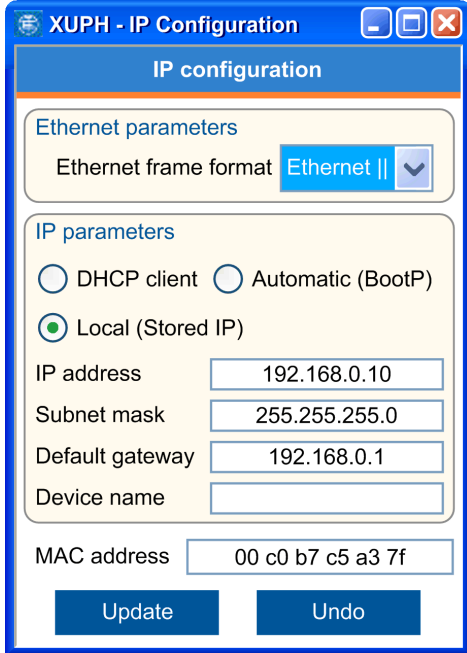
Step	Action
1	<p>From the XUPH Standalone applets Launcher, Ethernet Setup panel. Click IP Configuration.</p> <p>Result: the IP Configuration dialog box is displayed:</p> 
2	<p>Select the type of IP addressing:</p> <ul style="list-style-type: none"> ● DHCP client ● Automatic (BootP) ● Local (Stored IP)
3	<p>If local addressing is selected, set the parameters of the XUPH Communication Box</p> <ul style="list-style-type: none"> ● IP address ● Subnet mask ● Default gateway
4	Click Apply to validate the settings.
5	Cycle the XUPH Communication Box power off and on to apply the new settings.

Carefully manage the IP addresses because each device on the network requires a unique address. Having multiple devices with the same IP address can cause unpredictable operation of your network and associated equipment.

 **WARNING**

UNINTENDED EQUIPMENT OPERATION

- Verify that there is only one logic controller configured on the network.
- Verify that all devices have unique addresses.
- Obtain your IP address from your system administrator.
- Confirm that the IP address of the device is unique before placing the system into service.
- Do not assign the same IP address to any other equipment on the network.
- Update the IP address after cloning any application that includes Ethernet communications to a unique address.

Failure to follow these instructions can result in death, serious injury, or equipment damage.

NOTE: This device comes pre configured with an IP address of 192.168.0.10. Change this default address before using the device on the network. Remember to validate this change after resetting the device to factory defaults.

It is good practice to ensure that your system administrator maintains a record of all assigned IP addresses on the network and subnetwork, and to inform the system administrator of all configuration changes performed.

General Configuration

Follow the procedure to modify the XUPH Standalone applets Launcher configuration:

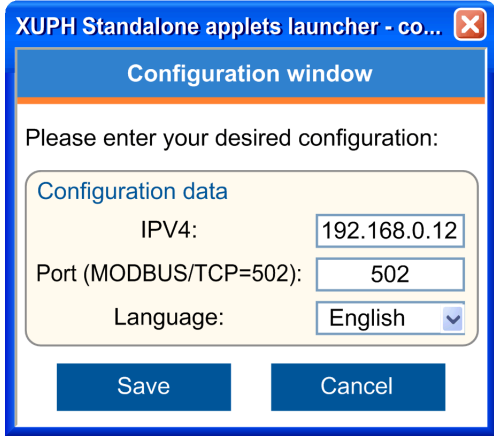
Step	Action
1	<p>From the XUPH Standalone applets Launcher, Ethernet Setup panel. Click General Configuration. Result: the Configuration window dialog box is displayed:</p> 
2	<p>Fill the fields IPV4 and Port to define the default IP address to be used by the XUPH Standalone applets Launcher. The factory settings are:</p> <ul style="list-style-type: none"> ● IPV4 = 192.168.0.10 ● Port = 502 ● Language = English
3	Select in the Language list the language of the XUPH Standalone applets Launcher.
4	Click Save .

User Accounts Configuration

Follow the procedure to modify a user account:

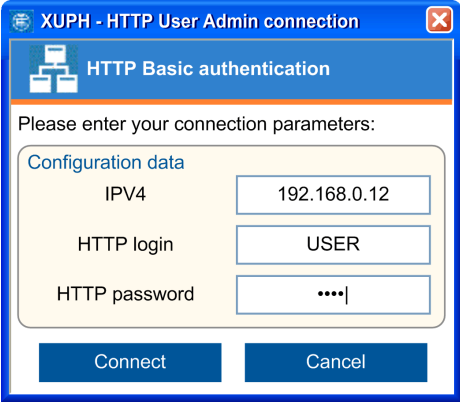
Step	Action
1	<p>From the XUPH Standalone applets Launcher, Ethernet Setup panel. Click HTTP users admin. Result: the HTTP Connection dialog box is displayed:</p> 
2	<p>Fill the fields HTTP User and HTTP Password. The factory settings are:</p> <ul style="list-style-type: none"> ● HTTP User = USER ● HTTP Password = USER

Step	Action
3	<p>Click Connect. Result: the HTTP User Administration dialog box is displayed:</p> 
4	<p>To create a user: Fill the fields Login and Password. Click Add.</p>
5	<p>To delete a user: Select a user in the list Users Login. Click Delete.</p>
6	<p>To modify a user: Select a user in the list Users Login. Enter the new password in the fields New Password and Confirm New Password. Click Update.</p>

Ethernet Ports Configuration

Follow the procedure to configure Ethernet ports:

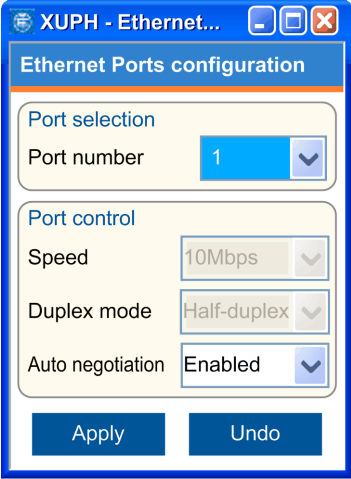
Step	Action
1	<p>From the XUPH Standalone applets Launcher, Ethernet Setup panel. Click Ethernet ports. Result: the Ethernet ports dialog box is displayed:</p> 
2	Select the Port Number to configure (1 or 2).
3	Select the Auto Negotiation mode (enabled or disabled).
4	<p>Configure the following parameters if the Auto Negotiation is disabled:</p> <ul style="list-style-type: none"> ● Speed <ul style="list-style-type: none"> ○ 10 Mbit/s ○ 100 Mbit/s ● Duplex mode <ul style="list-style-type: none"> ○ Half-duplex ○ Full-duplex
5	Click Apply to confirm the new settings.

Section 7.3

Internal Registers

Control Register

Description

The **Internal Registers** panel of the XUPH Standalone applets Launcher looks like this:

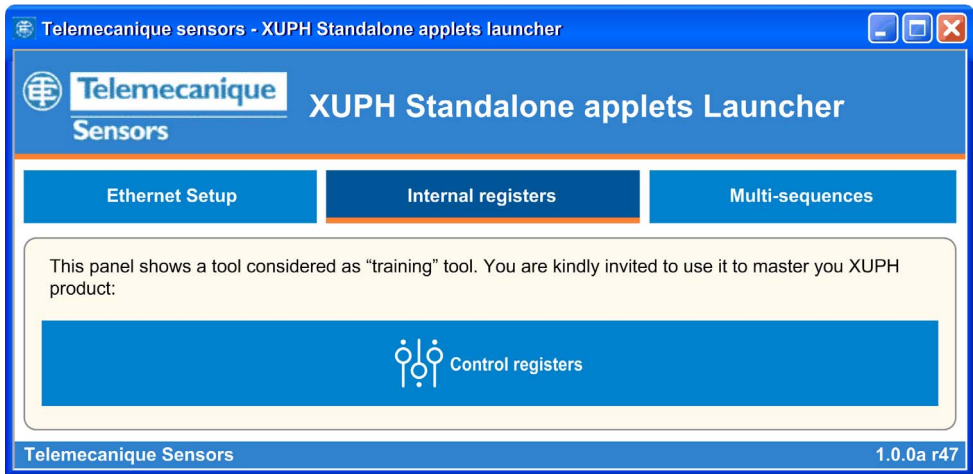

The **Internal Registers** panel ables to launch 1 tool:

Tools	Description
Control Registers (<i>see page 99</i>)	Ables to modify the main registers of the XUPH Communication Box.

Overview

The **Control Register** dialog box ables to read/write the words %MW00...%MW23 of a XUPH Communication Box (except %MW22 (Error Code) that is in read only).

Description

The **Control Register** dialog box looks like this:

XUPH - Control Registers applet

Telemecanique Sensors

Switch to edition mode Send modifications

Miscellaneous information

MW00: Current Mode MW04: Discrete Outputs (b2,b1,b0) MW22: Error Code No error

MW01: XUPK address

MW03: Last XUPK MW05: MW23:

MW02: Configuration information

Green LEDs (b0,b1) Red LEDs (b2,b3)

Fast Blinking (b4,b5) Slow Blinking (b6,b7)

Green LEDs Interaction (b8) Red LEDs Interaction (b9)

Sensors Tempo (b10,b11) Green LEDs Group (b12)

MW02 bits view hex: 15 51 b15...b0:

Green LED State & Configuration

	b15	b14	b13	b12	b11	b10	b9	b8	b7	b6	b5	b4	b3	b2	b1	b0
MW10	0	0	0	0	0	0	0	0	0	0	0	0	0	0	0	0
MW11	0	0	0	0	0	0	0	0	0	0	0	0	0	0	0	0
MW12	0	0	0	0	0	0	0	0	0	0	0	0	0	0	0	0
MW13	0	0	0	0	0	0	0	0	0	0	0	0	0	0	0	0





Red LED State & Configuration

	b15	b14	b13	b12	b11	b10	b9	b8	b7	b6	b5	b4	b3	b2	b1	b0
MW14	0	0	0	0	0	0	0	0	0	0	0	0	0	0	0	0
MW15	0	0	0	0	0	0	0	0	0	0	0	0	0	0	0	0
MW16	0	0	0	0	0	0	0	0	0	0	0	0	0	0	0	0
MW17	0	0	0	0	0	0	0	0	0	0	0	0	0	0	0	0

Sensors state

	b15	b14	b13	b12	b11	b10	b9	b8	b7	b6	b5	b4	b3	b2	b1	b0
MW18	0	0	0	0	0	0	0	0	0	0	0	0	0	0	0	0
MW19	0	0	0	0	0	0	0	0	0	0	0	0	0	0	0	0
MW20	0	0	0	0	0	0	0	0	0	0	0	0	0	0	0	0
MW21	0	0	0	0	0	0	0	0	0	0	0	0	0	0	0	0

Connected to 192.168.0.12:502. Is running (500ms). 1.0.0a r45

Zone	Element	Description
1	Header	 Switch to help mode (<i>see page 108</i>)
		 Opens a dialog box to change the IP address of the XUPH Communication Box to control.
		 Switch to edition mode: you can modify the values in the registers.
		 Send the modification to the XUPH Communication Box. NOTE: The button is enabled in edition mode only.
2	Miscellaneous information	MW0 Operating modes (<i>see page 49</i>)
		MW1 Picking Sensors addressing (<i>see page 50</i>)
		MW3 Sequence step number (<i>see page 56</i>)
		MW4 Sequence number (<i>see page 57</i>)
		MW5 Sequence management (<i>see page 58</i>)
		MW22 Detected error codes (<i>see page 53</i>)
MW23 Diagnostic (<i>see page 54</i>)		
3	MW2 Configuration information	Picking Sensors LEDs configuration (<i>see page 65</i>)
4	Green LEDs status	MW6...MW13 Picking Sensors Green LEDs status (<i>see page 71</i>)
5	Red LEDs status	MW14...MW17 Picking Sensors Red LEDs status (<i>see page 71</i>)
6	Sensors status	MW18...MW21 Sensors status of the Picking Sensors (<i>see page 73</i>)
7	Footer	- Indicates the XUPH Communication Box connection status.

NOTE: In Multi-sequences Mode (Mode 3), the zones 3, 4, 5, 6 are hidden.



In PLC Mode (Mode 4), the sensor status values are dynamic: when you come through the beam of a Picking Sensor, the corresponding bit pass to 1.

When the right and left green LEDs are not grouped (bit 12 of the %MW2 = 0), the zone 4 is split in two zones:

- Registers %MW6...%MW9 (Left green LEDs).
- Registers %MW10...%MW13 (Right green LEDs).

Modify Register Values of a Picking Sensor

Proceed as follow to modify register values of a Picking Sensor:

Step	Action
1	Click  .
2	Modify one or more register values.
3	Click  . Result: The registers are updated. The edition mode is left.

Section 7.4

Multi-sequences

What Is in This Section?

This section contains the following topics:

Topic	Page
Multi-sequences	104
Remote Controller	105
Save/Restore	109

Multi-sequences

Description

The **Multi-sequences** panel of the XUPH Standalone applets Launcher looks like this:

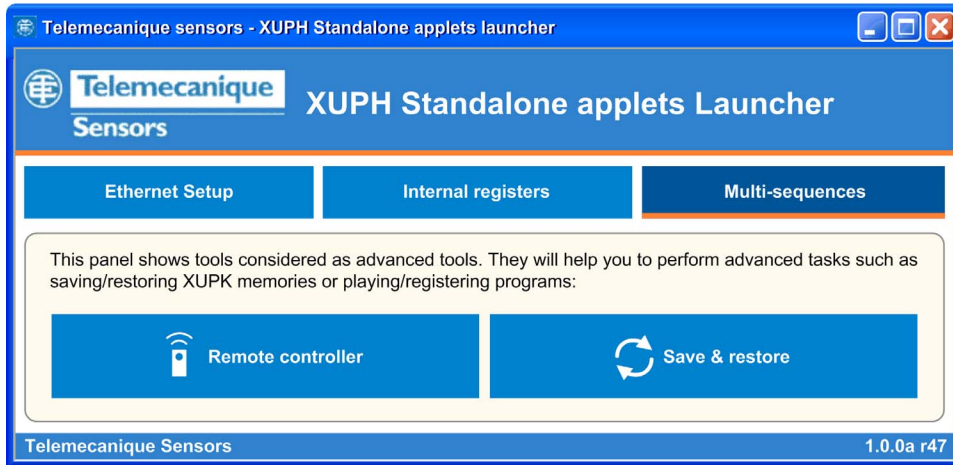

The **Multi-sequences** panel ables to launch 2 tools:

Tools	Description
Remote Controller (<i>see page 105</i>)	Ables to manage the automatic sequences (start/stop sequence, select sequence number, start/stop manual sequence teaching).
Save/Restore (<i>see page 109</i>)	Ables to save and restore the memory of the Picking Sensors.

Remote Controller









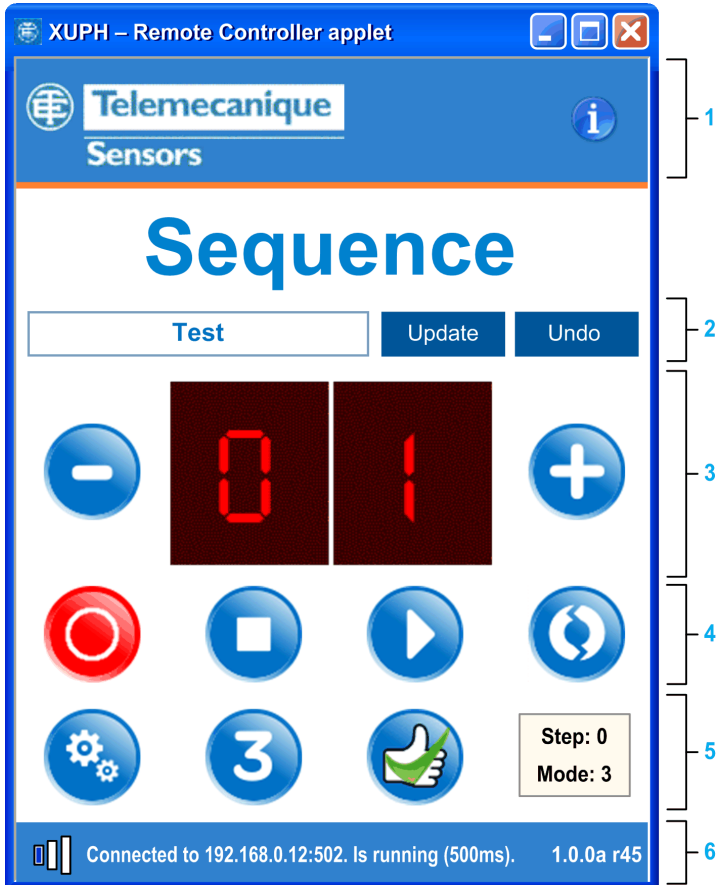

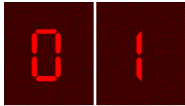

Overview

The **Remote Controller** dialog box enables to manage the automatic sequences (start/stop sequence, select sequence number, start/stop manual sequence teaching).

Description



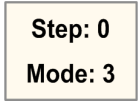

The **Remote Controller** dialog box looks like this:



Zone	Element	Description	
1	Header 	Switch to help mode (see page 108)	
2	Sequence name Text field	Contain the name of the selected sequence	
		Save the sequence name	
		Cancel the last entry	
3	Sequence number 	Decrease the sequence number by 1 (-1) Auto decrement when held down	
		Displays the current sequence number.	
		Increase the sequence number by 1 (+1) Auto increment when held down	
4	Sequence management 	Start/Stop the manual sequence teaching	
		Stop the running sequence	
		Play the selected sequence: 1 time	
		Play the selected sequence: in loop (the sequence restarts automatically)	
5	Configuration 	Opens a dialog box to change the IP address of the XUPH Communication Box to control.	
		Configures all the connected Picking Sensors in Multi-sequences Mode (Mode 3).	
	Information 	Running sequence status: OK / Wrong take detected	
		STEP: XX	Indicates the current step of the running sequence.
		Mode: 3 or Mode 4	Indicates the XUPH Communication Box mode defined in %MW0 (see page 49)
6	Footer -	Indicates the XUPH Communication Box connection status.	





Record a Sequence

Proceed as follow to record a sequence:

Step	Action
1	Click  and  to select a sequence number.
2	Click  to start the manual teaching of the sequence. Result: The Picking Sensors are flashing green.
3	Come through the beam of the first Picking Sensor of the sequence to define the first part to be taken. Result: Picking Sensor green LEDs light ON.
4	Wait until Picking Sensor green LEDs light OFF (2 seconds). NOTE: For wide container zone, you can associate 2 or more Picking Sensors. Come through the beam of the others Picking Sensors of the zone during this 2 seconds period to associate them to the first one activated in the zone.
5	Repeat steps 3 and 4 for the needed Picking Sensors until the end of the sequence.
6	Click  to stop the sequence teaching. Result: The Picking Sensors are flashing green 3 times.
7	In addition, type a sequence name in the field. Click Update to save the name sequence.

Play a Sequence

Proceed as follow to play a sequence:

Step	Action
1	Click  and  to select a sequence number.
2	In this page, you can: <ul style="list-style-type: none"> Click  to play the selected sequence: 1 time Click  to play the selected sequence: the sequence restarts automatically. Result: <ul style="list-style-type: none"> If the sequence exists, the sequence starts: the first Picking Sensor green LEDs light ON If the sequence does not exist, all Picking Sensors red LEDs blink 3 times.

Help Mode

Click  to switch to help mode:

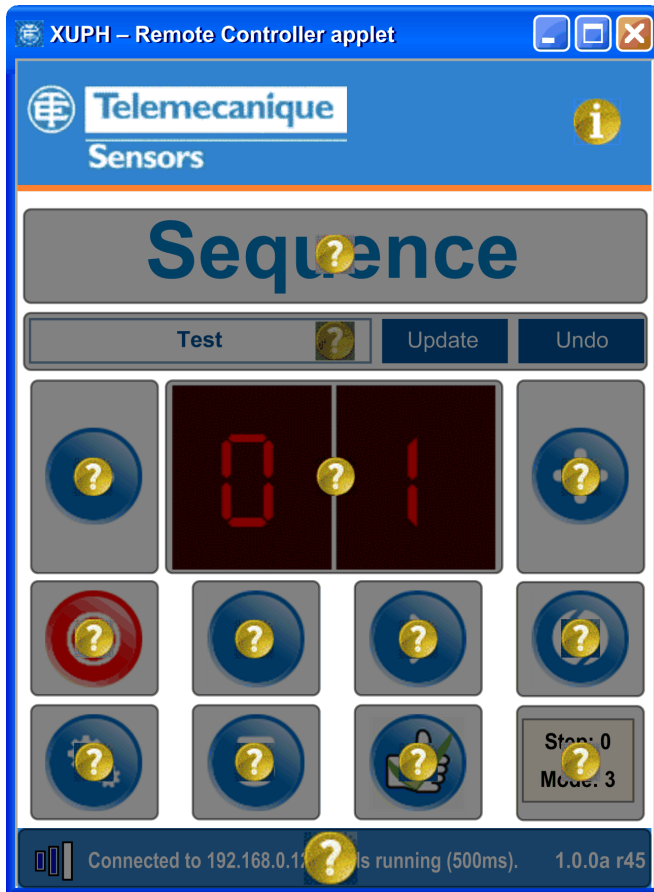

In this mode, place the cursor on a symbol to display a description pop-up of the corresponding element.

Click again  to return to operation mode.

Save/Restore

Overview

The **Save/Restore** dialog box is used to save/restore the sequences taught in Multi-sequences Mode (Mode 3). These sequences are stored in each Picking Sensor memory.

The main use is to replace one or several out-of-order Picking Sensors quickly.

NOTE: To be saved/restored, the Picking Sensor must have a unique address (*see page 51*).



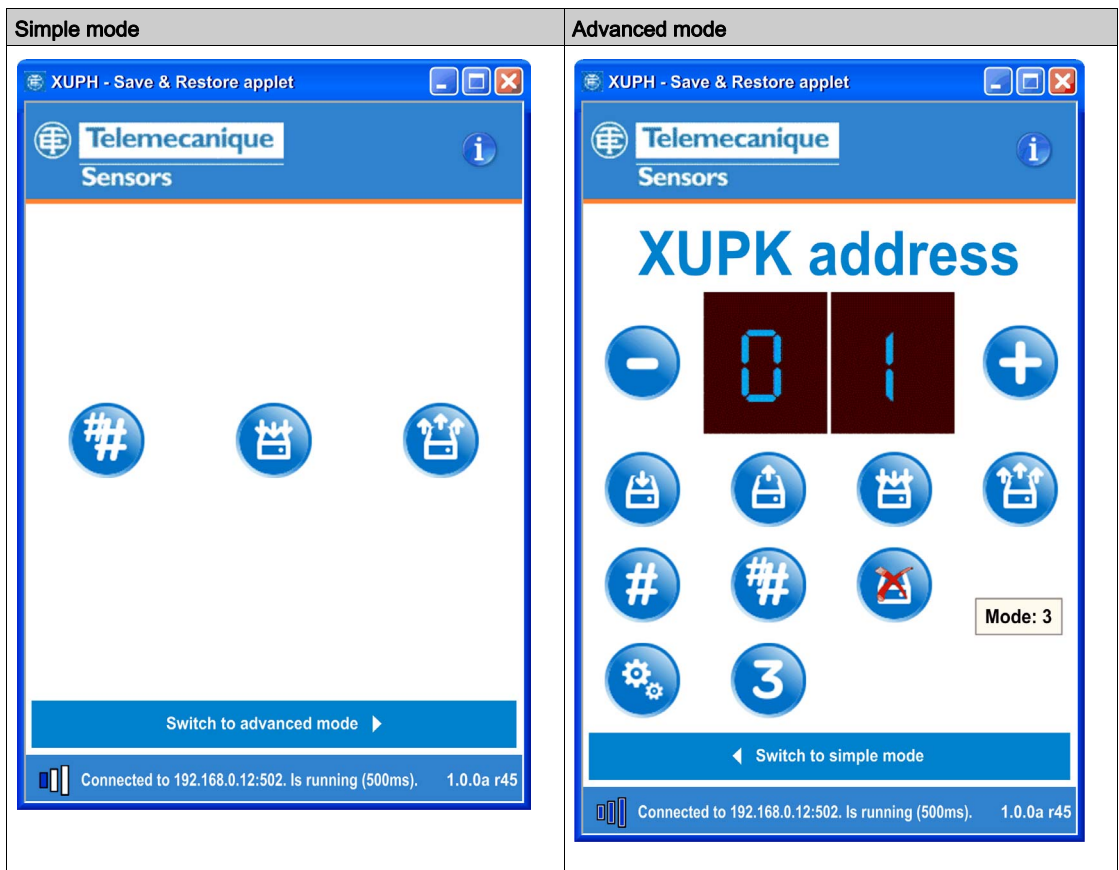

Description



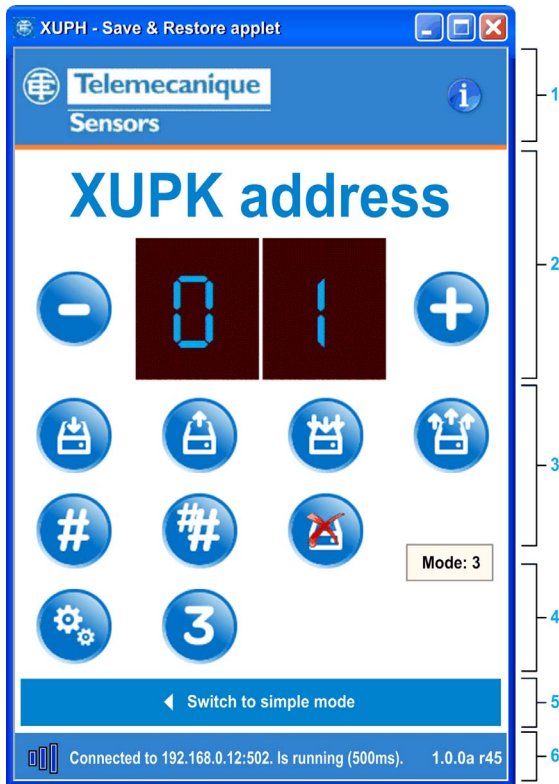





The **Save & Restore** dialog box has 2 different modes:



The **Save & Restore** dialog box looks like this:





Zone	Element	Description
1	Header	 Switch to help mode (<i>see page 108</i>)
2	Picking Sensor address	 Decrease the Picking Sensor address number by 1 (-1) Auto decrement when held down
		 Displays the selected Picking Sensor address number
		 Increase the Picking Sensor address number by 1 (+1) Auto increment when held down

Zone		Element	Description
3	Save/Restore tools		Save the memory of the selected Picking Sensor.
		Restore the memory of the selected Picking Sensor.	
		Save the memory of all Picking Sensors.	
		Restore the memory of several Picking Sensors.	
		Configure the address of one Picking Sensor defined by the selected sensor address.	
		Configure the address of all Picking Sensors.	
		Stop the save or restore procedure in progress.	
4	Configuration		Opens a dialog box to change the IP address of the XUPH Communication Box to control.
	Configures all the connected Picking Sensors in Multi-sequences Mode (Mode 3).		
Information	Mode: 3	Mode 3 or Mode 4 Indicates the XUPH Communication Box mode defined in %MW0 (see page 49)	
5	Save/Restore mode	-	Switch between Simple mode and Advanced mode .
6	Footer	-	Indicates the XUPH Communication Box connection status.



Configure the Address of one Picking Sensor

Proceed as follow to configure the address of one Picking Sensor:

Step	Action
1	Click  and  to select a Picking Sensor address.
2	Click  Result: The Picking Sensors are flashing green. If the address is already used, the corresponding Picking Sensor is flashing red.
3	Come through the beam of the Picking Sensor to be addressed. Result: The Picking Sensor lights green for 1 second. After this delay, all Picking Sensors light OFF. If the address is already used, the corresponding Picking Sensor (red flashing) is unaddressed.

Configure the Address of All the Picking Sensors

Proceed as follow to configure the address of all the Picking Sensors:

Step	Action
1	Click  Result: The Picking Sensors are flashing green. The button becomes  and the other operating buttons becomes enabled (grayed).
2	Come through the beam of the first Picking Sensor to be addressed. Result: This Picking Sensor lights OFF. Its address is 1.
3	Repeat the step 2 with each Picking Sensor. The address is automatically incremented.
4	Click  Result: The Picking Sensors light OFF.

NOTICE



INOPERABLE EQUIPMENT

You must consider that clicking  reset the address of all the connected Picking Sensors.

Failure to follow these instructions can result in equipment damage.

Save Memory of one Picking Sensor

Proceed as follow to save the memory of one Picking Sensor:

Step	Action
1	Click  and  to select a Picking Sensor address.
2	Click  . Result: A dialog box appears to select the folder where the memory file of the selected Picking Sensor will be saved.
3	Select the folder.
4	Click Save . Result: The procedure begins: <ul style="list-style-type: none"> • The Picking Sensors are flashing green. • The selected Picking Sensor is flashing red during the procedure.
5	Wait until the end of the procedure. Result: At the end of the procedure, a confirmation message indicates the Picking Sensor saved.
6	Click Ok . Result: The Picking Sensors light OFF.

NOTE: For each Picking Sensor, a binary file has been created in the selected folder.

Save Memory of All the Picking Sensors



Proceed as follow to save the memory of all the Picking Sensors:

Step	Action
1	Click  . Result: A dialog box appears to select the folder where the memory files of the Picking Sensors will be saved.
2	Select the folder.
3	Click Save all . Result: The procedure begins: <ul style="list-style-type: none"> • The Picking Sensors are flashing green. • Each Picking Sensor is flashing red during its saving procedure.
4	Wait until the end of the procedure. Result: A confirmation message is displayed at the end of the procedure to indicate the number of Picking Sensors saved.
5	Click Ok . Result: The Picking Sensors light OFF.

NOTE: For each Picking Sensors, a binary file has been created in the selected folder.

Restore Memory of one Picking Sensor

Proceed as follow to restore the memory of one Picking Sensor:

Step	Action
1	Click  and  to select a Picking Sensor address.
2	Click  Result: A dialog box appears to select the memory file of the selected Picking Sensor previously saved.
3	Select the memory file.
4	Click Restore . Result: The procedure begins: <ul style="list-style-type: none"> • The Picking Sensors are flashing green. • The selected Picking Sensor is flashing red during the procedure.
5	Wait until the end of the procedure. Result: At the end of the procedure, a confirmation message indicates the Picking Sensor restored.
6	Click Ok . Result: The Picking Sensors light OFF.

Restore Memory of All the Picking Sensors

Proceed as follow to restore the memory of all the Picking Sensors:

Step	Action
1	Click  Result: A dialog box appears to select the folder where the memory files of the Picking Sensors have previously been saved.
2	Select the folder.
3	Click Restore all . Result: The procedure begins: <ul style="list-style-type: none"> • The Picking Sensors are flashing green. • Each Picking Sensor is flashing red during its restoring procedure.
4	Wait until the end of the procedure. Result: At the end of the procedure, a confirmation message indicates the number of Picking Sensors restored.
5	Click Ok . Result: The Picking Sensors light OFF.



!

%

According to the IEC standard, % is a prefix that identifies internal memory addresses in the logic controller to store the value of program variables, constants, I/O, and so on.

%MW

According to the IEC standard, %MW represents a memory word register (for example, a language object of type memory word).

100Base-TX

An adaptation of the IEEE 802.3u (Ethernet) standard, the 100Base-T standard uses 2 twisted-pair wiring with a maximum segment length of 100 m (*328 ft*) and terminates with an RJ45 connector. A 100Base-T network is a baseband network capable of transmitting data at a maximum speed of 100 Mbit/s. "Fast Ethernet" is another name for 100Base-T because it is 10 times faster than 10Base-T.

10Base-T

An adaptation of the IEEE 802.3 (Ethernet) standard, the 10Base-T standard uses twisted-pair wiring with a maximum segment length of 100 m (*328 ft*) and terminates with an RJ45 connector. A 10Base-T network is a baseband network capable of transmitting data at a maximum speed of 10 Mbit/s.

802.3 frame

A frame format, specified in the IEEE 802.3 (Ethernet) standard, in which the header specifies the data packet length.

A

AWG

(*American wire gauge*) The standard that specifies wire section sizes in North America.

B

BOOTP

(*bootstrap protocol*) A UDP network protocol that can be used by a network client to automatically obtain an IP address (and possibly other data) from a server. The client identifies itself to the server using the client MAC address. The server, which maintains a pre-configured table of client device MAC addresses and associated IP addresses, sends the client its pre-configured IP address. BOOTP was originally used as a method that enabled diskless hosts to be remotely booted over a network. The BOOTP process assigns an infinite lease of an IP address. The BOOTP service utilizes UDP ports 67 and 68.

C

configuration

The arrangement and interconnection of hardware components within a system and the hardware and software selections that determine the operating characteristics of the system.

CRC

(cyclical redundancy check) A method used to determine the validity of a communication transmission. The transmission contains a bit field that constitutes a checksum. The message is used to calculate the checksum by the transmitter according to the content of the message. Receiving nodes, then recalculate the field in the same manner. Any discrepancy in the value of the 2 CRC calculations indicates that the transmitted message and the received message are different.

D

DFB

(derived function block)

DHCP

(dynamic host configuration protocol) An advanced extension of BOOTP. DHCP is more advanced, but both DHCP and BOOTP are common. (DHCP can handle BOOTP client requests.) This TCP/IP protocol that allows a server to assign an IP address based on a device name (host name) to a network node

E

EDS

(electronic data sheet) A file for fieldbus device description that contains, for example, the properties of a device such as parameters and settings.

EMC

(electromagnetic compatibility). Devices that meet EMC requirements can operate within a system expected electromagnetic limits without interruption.

Ethernet

A physical and data link layer technology for LANs, also known as IEE 802.3. Ethernet uses a bus or a star topology to connect different nodes on a network.

Ethernet II

A frame format in which the header specifies the packet type, Ethernet II is the default frame format for NIM communications.

EtherNet/IP

EtherNet/IP (the Ethernet Industrial Protocol) is especially suited to factory applications in which there is a need to control, configure, and monitor events within an industrial system. The ODVA-specified protocol runs CIP (the Common Industrial Protocol) on top of standard Internet protocols, like TCP/IP and UDP. It is an open local (communications) network that enables the interconnectivity of all levels of manufacturing operations from the office plant to the sensors and actuators on its floor.

H**HTTP**

hypertext transfer protocol. The protocol that a web server and a client browser use to communicate with one another.

I**IEC**

International Electrotechnical Commission. Founded in 1884 to focus on advancing the theory and practice of electrical, electronics, and computer engineering, and computer science. EN 61131-2 is the specification that deals with industrial automation equipment.

IEEE

(institute of electrical and electronics engineers) A non-profit international standards and conformity assessment body for advances in electrotechnology.

IP

(Internet protocol) Part of the TCP/IP protocol family that tracks the Internet addresses of devices, routes outgoing messages, and recognizes incoming messages.

IP rating

Ingress Protection rating according to IEC 60529.

L**LAN**

(local area network) A short-distance communications network that is implemented in a home, office, or institutional environment.

LED

(light emitting diode) An indicator that illuminates under a low-level electrical charge.

LSB

(least significant bit/byte) The part of a number, address, or field that is written as the right-most single value in conventional hexadecimal or binary notation.

M

MAC address

(media access control address) A unique 48-bit number associated with a specific piece of hardware. The MAC address is programmed into each network card or device when it is manufactured.

master/slave model

The direction of control in a network that implements the master/slave model is from the master to the slave devices.

Modbus

Modbus is an application layer messaging protocol. Modbus provides client and server communications between devices connected on different types of buses or networks. Modbus offers many services specified by function codes.

MSB

(most significant bit/byte) The part of a number, address, or field that is written as the left-most single value in conventional hexadecimal or binary notation.

P

PELV

protective extra low voltage.

PLC

(programmable logic controller) An industrial computer used to automate manufacturing, industrial, and other electromechanical processes. PLCs are different from common computers in that they are designed to have multiple input and output arrays and adhere to more robust specifications for shock, vibration, temperature, and electrical interference among other things.

R

RJ45

A standard type of 8-pin connector for network cables defined for Ethernet.

Rx

reception.

S

SCADA

(supervisory control and data acquisition) A system that monitors, manages, and controls industrial applications or processes, usually for entire sites or complexes of systems spread over large areas.

subnet

A part of a network that shares a network address with the other parts of a network. A subnet may be physically and/or logically independent of the rest of the network. A part of an Internet address called a subnet number, which is ignored in IP routing, distinguishes the subnet.

T**TCP**

(transmission control protocol) A connection-based transport layer protocol that provides a simultaneous bi-directional transmission of data. TCP is part of the TCP/IP protocol suite.

Tx

transmission.

U**UDP**

(user datagram protocol) A connectionless mode protocol (defined by IETF RFC 768) in which messages are delivered in a datagram (data telegram) to a destination computer on an IP network. The UDP protocol is typically bundled with the Internet protocol. UDP/IP messages do not expect a response, and are therefore ideal for applications in which dropped packets do not require retransmission (such as streaming video and networks that demand real-time performance).

W**WORD**

A type encoded in a 16-bit format.



F

frame type

- Ethernet II, *78*
- IEEE 802.3, *78*

I

IP address configuration, *42*

M

Modbus function codes, *79*
Modbus over TCP/IP
 data formats, *78*
Modbus protocol, *78*

N

network topology, *18*

P

PLC, *78*

T

topology, *18*

W

web server
 setup, *43*

