



Underscore® Rectangle 6' Bubblemassage™ Whirlpool Bath K-1174-XH2G

Features

- 122 airjets release thousands of bubbles that surround, support, and massage the body.
- Variable-speed blower lets you adjust airjet massage intensity to 18 levels.
- Zones of Control™ feature allows you to target massage to back, midsection, or feet.
- 8 hydromassage jets can be individually adjusted for water flow and direction.
- Variable-speed pump for adjusting hydromassage intensity.
- Built-in heater.
- Lighted keypads.
- Generous 6-foot length provides an incredibly spacious bathing area.
- Sloping backrest provides comfort.
- Slotted overflow allows for deep soaking.
- Immediate and manual purge cycles remove residual water from air channels after use.
- Center drain.

Material

- Acrylic.

Hydrotherapy

- BubbleMassage.
- Whirlpool.

Installation

- Drop-in or undermount.
- Requires 240V hard-wire electrical service.
- Under-mount installation requires kit K-592 (sold separately).

Required Products/Accessories

K-7271 Brass Slotted Overflow Bath Drain

or

K-7272 PVC Slotted Overflow Bath Drain

or

K-9698 Flexjet® Whirlpool Trim Kit

Recommended Products/Accessories

K-1491 Bath/Whirlpool Pillow

K-1601 Bath/Whirlpool Footstop

K-9497 2-1/2" Keypad Trim

K-593 Under-Mount Installation Kit

K-24916 Wireless Music Kit

K-592 Under-Mount Installation Kit

K-23726 Drain treatment

K-23732 Tub & shower cleaner



Codes/Standards

ASME A112.19.7/CSA B45.10

CSA B45.5/IAPMO Z124

ASTM E162

ASTM E662

UL 1795





CSA C22.2 No. 218.2

**KOHLER® Plastic Baths and Receptors
Lifetime Limited Warranty
KOHLER® Hydrotherapy Components
Five-Year Limited Warranty**

See website for detailed warranty information.

Available Colors/Finishes

Color tiles intended for reference only.

Color	Code	Description
	0	White
	NY	Dune
	G9	Sandbar
	33	Mexican Sand™
	K4	Cashmere

1-800-4KOHLER (1-800-456-4537)

Kohler Co. reserves the right to make revisions without notice to product specifications.

For the most current Specification Sheet, go to www.kohler.com.

4-28-2020 06:21 - US/CA

THE BOLD LOOK
OF **KOHLER**®

No change in measurements if connected with drain illustrated. (K-7272)

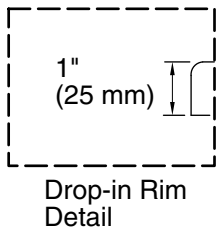

Blower Motor/
Control Access
30" (762 mm) W x
15" (381 mm) H Min

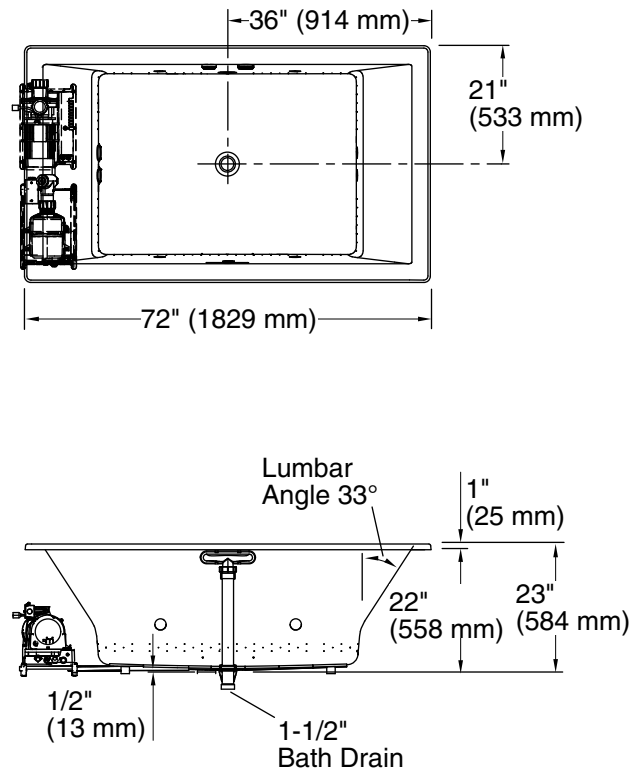
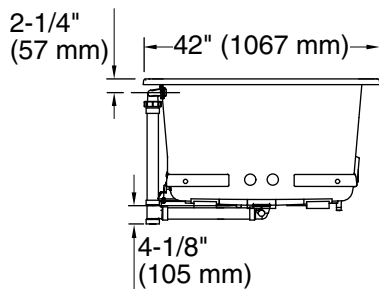

Required Electrical Service

One dedicated circuit required, protected with Class A Ground-Fault Circuit-Interrupter (GFCI). Outside North America, this device may be known as a Residual Current Device (RCD).

Blower, Pump: 220-240 V, 20 A, 50/60 Hz

Technical Information

All product dimensions are nominal.

Installation:	Drop-in, Under-mount
Drain location:	Center
Basin area, bottom:	45-3/4" x 32" (1162 mm x 813 mm)
Basin area, top:	66" x 36" (1676 mm x 914 mm)
Weight:	203 lbs (92.1 kg)
Minimum floor load:	64.1 lbs/ft ² (313 kg/m ²)
Water depth:	19" (483 mm)
Water capacity:	139 gal (526.2 L)
Cutout:	Drop-in, 71-1/2" x 41-1/2" (1816 mm x 1054 mm)
Electrical component rating:	Blower: 220-240 V, 3 A, 50/60 Hz Pump: 220-240 V, 11 A, 50/60 Hz
Minimum flat for door:	2-1/2" (64 mm)

Notes

Measure your actual product for rough-in details. Install this product according to the installation instructions.

The hot water supply should be 70% of the capacity of the bath or greater. Installations will vary.

Kit is required for under-mount installations (sold separately).

IMPORTANT! Dry fit the drain assembly prior to installing the bath. The bath cannot be installed with all drain components attached.